

SPL-54B33B-G / SPL-54B33B-AG

(RoHS Compliant)

3.3V / 622 Mbps 1490 nm Continuous-Mode TX / 155 Mbps 1310 nm Burst-Mode RX

ITU-T G.983.3 B-PON CLASS B SFP OLT Transceiver (with Reset-Less RX)

FEATURES

- | Class B Optical Line Terminal (OLT) for ITU-T G.983.3 B-PON
- | SFP **SC** Transceiver
- | 622 Mbps / 1490 nm Continuous-Mode Transmitter
- | 155 Mbps / 1310 nm Burst-Mode Receiver with 2R Output
- | **Resetless BM Receiver Design**
- | BM RX capable of Handling Packet-to-Packet Spacing with Guard Time less than 50 ns for 15dB Packet Optical Power Difference
- | High Resistance of BM RX to DC Optical Background
- | 0 to 70°C Operating: SPL-54B33B-G
- | -20 to 85°C Operating: SPL-54B33B-AG
- | **RoHS Compliant**
- | Single +3.3 V Power Supply
- | Transmitter: AC Coupling Input
- | Receiver: DC Coupling Output
- | Class 1 Laser International Safety Standard IEC 60825 Compliant

DESCRIPTION

SPL-54B33B series is a small form factor pluggable transceiver for ITU-T G.983.3 Class B optical line terminal (OLT) with 622 Mbps/1490 nm in downstream and 155 Mbps /1310 nm in upstream. It is with the SFP 20-pin connector to allow hot plug capability. The SPL-54B33B series is high performance module for single fiber communications by using 1490 nm continuous-mode transmitter and 1310 nm burst-mode receiver. The transmitter section uses a multiple quantum well 1490 nm DFB laser and is a class 1 laser compliant according to International Safety Standard IEC 60825. The receiver section uses an integrated 1310 nm burst-mode detector preamplifier (IDP) mounted in an optical header and a burst-mode limiting post-amplifier IC. **Unlike the conventional BM RX, the RX does not requires reset pulse to receive optical data packets with different optical power.**

LASER SAFETY

This single mode transceiver is a Class 1 laser product. It complies with IEC 60825 and FDA 21 CFR 1040.10 and 1040.11. The transceiver must be operated within the specified temperature and voltage limits. The optical ports of the module shall be terminated with an optical connector or with a dust plug.

APPLICATIONS

- | Broadband PON System
- | ATM PON System

ORDER INFORMATION

P/No	Class	TX				RX				Temp (°C)	Package	RoHS Compliant
		Type	Speed (Mb/s)	λ (nm)	Power (dBm)	Type	Speed (Mb/s)	λ (nm)	Sens. (dBm)			
SPL-54B33B-G	B	CNT	622	1490 DFB	4 / -1	BM, 2R	155	1310	-8 / -31	0 / 70	SC SFP	Yes
SPL-54B33B-AG	B	CNT	622	1490 DFB	4 / -1	BM, 2R	155	1310	-8 / -31	-20 / 85	SC SFP	Yes

Absolute Maximum Ratings					
Parameter	Symbol	Min	Max	Units	Notes
Storage Temperature	Tstg	-40	85	°C	
Operating Case Temperature	Topr	0	70	°C	SPL-54B33B-G SPL-54B33B-AG
Power Supply Voltage	Vcc	-0.5	3.6	V	

Recommended Operating Conditions					
Parameter	Symbol	Min	Max.	Unit	Units / Notes
Power Supply Voltage	Vcc	3.13	3.47	V	V
Operating Case Temperature	Topr	0	70	°C	SPL-54B33B-G SPL-54B33B-AG
Power Supply Current	I _{CC(TX+RX)}		300	mA	

Transmitter Specifications (0°C < Topr < 70°C, 3.13V < Vcc < 3.47V)

Parameter	Symbol	Min.	Typ.	Max.	Units	Notes
Optical						
Optical Transmit Power	P _o	-1		4	dBm	1
Output Center Wavelength	λ	1480		1500	nm	
Output Spectrum Width	Δ λ			1	nm	-20 dB Width
Side Mode Suppression Ratio	SMSR	30			dB	
Extinction Ratio	E _R	10			dB	
Data Rate			622		Mb/s	
Optical Rise Time				1.0	ns	10% to 90% Values
Optical Fall Time				1.0	ns	10% to 90% Values
Relative Intensity Noise	RIN			-120	dB/Hz	
Total Jitter				0.55	ns	
Electrical						
Data Input Current – Low		-350			μA	
Data Input Current – High				350	μA	
Differential Input Voltage	V _{IH} - V _{IL}	0.4		2.4	V	Peak-to-Peak
TX Disable Input Voltage – Low	T _{DIS, L}	0		0.8	V	2
TX Disable Input Voltage – High	T _{DIS, H}	2.0		V _{cc}	V	2
TX Disable Assert Time	T _{ASSERT}			10	μs	
TX Disable Deassert Time	T _{DEASSERT}			1	ms	
TX Fault Output Voltage -- Low	T _{FaultL}	0		0.5	V	3
TX Fault Output Voltage -- High	T _{FaultH}	2.0		V _{cc} +0.3	V	3

1. Output power is power coupled into a 9/125 μm single mode fiber.
2. There is an internal 4.7K to 10K ohm pull-up resistor to VccTX.
3. Open collector compatible, 4.7K to 10K ohm pull-up to Vcc (Host Supply Voltage).

Receiver Characteristics (0°C < Topr < 70°C, 3.13V < Vcc < 3.47V)

Parameter	Symbol	Min.	Typ.	Max.	Units	Notes
Optical						
Sensitivity	Sen			-31	dBm	4
Saturation Optical Power	Sat	-8			dBm	4
Wavelength of Operation		1260		1360	nm	5
Data Rate			155		Mb/s	
Packet-to-Packet Guard Time	tg	50			ns	6,7
DC Optical Tolerance		Sen +3			dB	
Optical Return Loss		14			dB	
Electrical						
Data Output Voltage – Low	V _{OL} - V _{CC}	-2.0		-1.58	V	8
Data Output Voltage – High	V _{OH} - V _{CC}	-1.1		-0.74	V	8
Signal Detect Output Voltage -- Low	V _{OL}			0.5	V	
Signal Detect Output Voltage -- High	V _{OH}	2.0			V	
Signal Detect Assert Time	AS _{MAX}	10	15	30	ns	Transition: low to high
Signal Detect Deassert Time	ANS _{MAX}	500	550	700	ns	Transition: high to low
Rest Between Packet				Resetless		

4. Sensitivity and saturation levels at BER 1E-10 for a PRBS 2²³-1 @ER=10.
5. At least 30 dB optical isolation for the wavelength 1480 to 1500 nm.
6. No reset is needed.
7. The optical power difference between neighboring packets is up to 15 dB at 155 Mbps.
8. These inputs are compatible with 10K, 10KH and 100K ECL and LVPECL outputs.

BM CLOCK & DATA RECOVERY

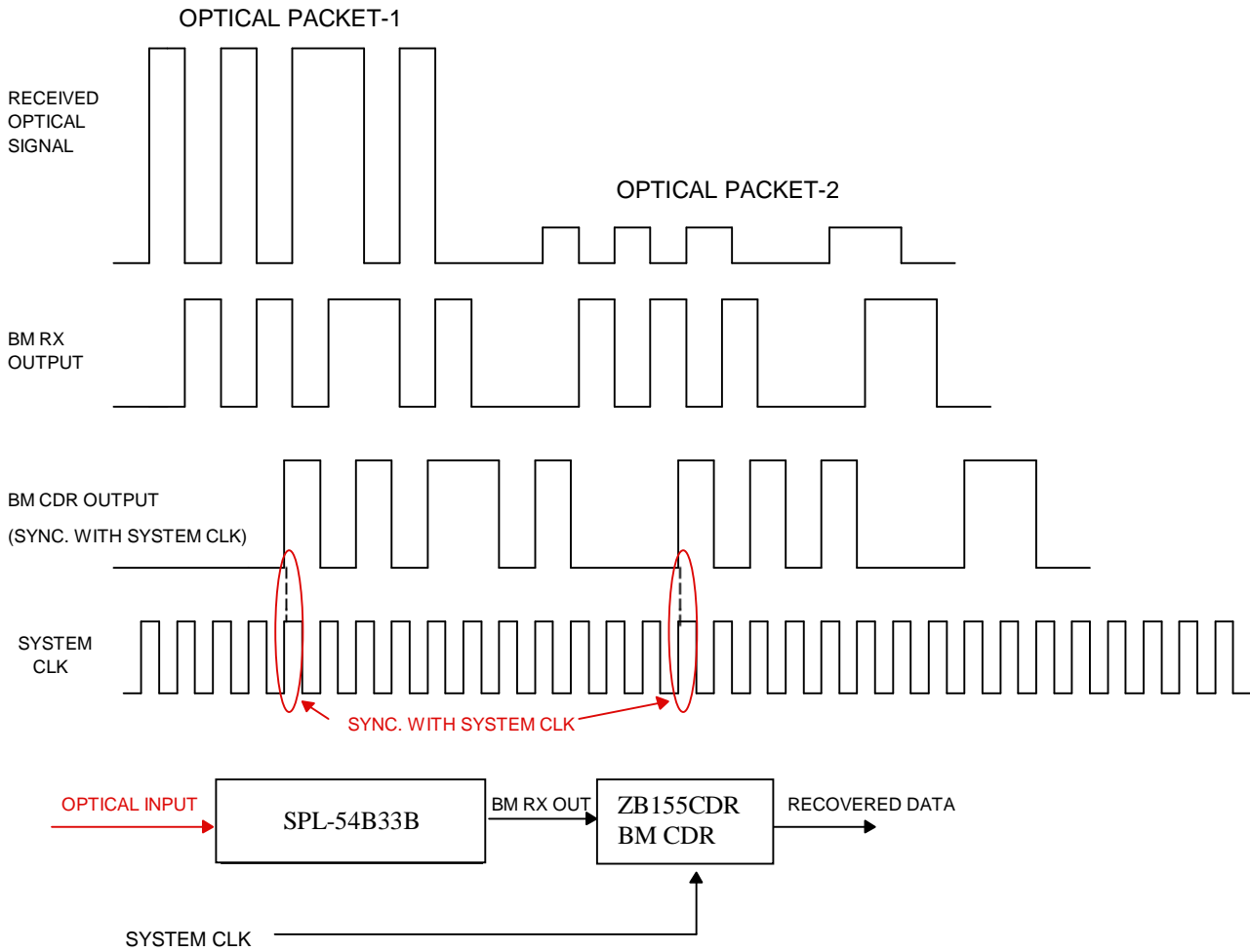

CONNECTION DIAGRAM

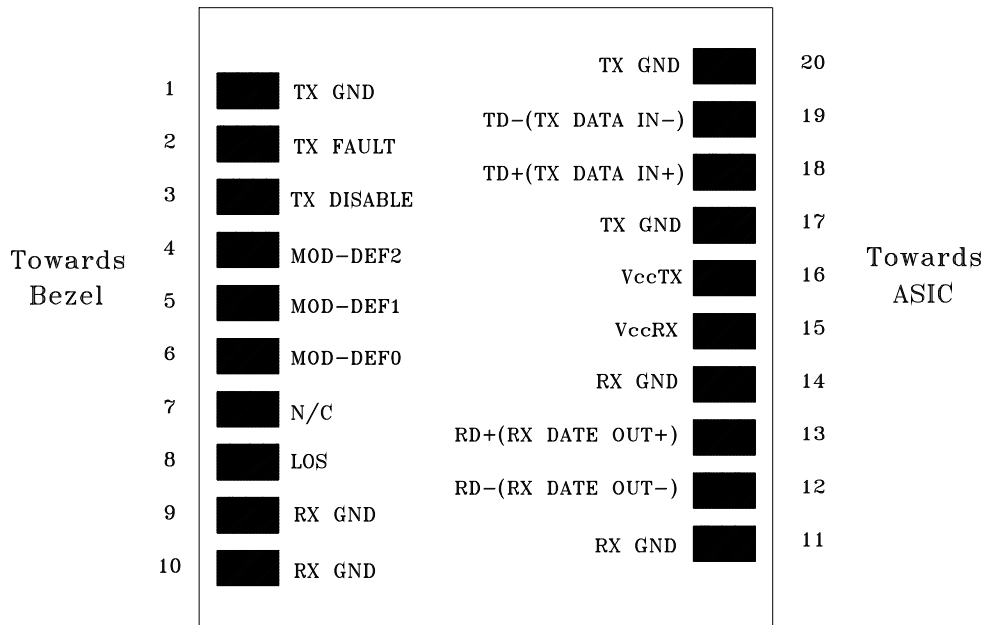

PIN	Signal Name	Description	PIN	Signal Name	Description
1	TX GND	Transmitter Ground	11	RX GND	Receiver Ground
2	TX Fault	Transmitter Fault Indication	12	RX DATA OUT-	Inverse Receiver Data Out
3	TX Disable	Transmitter Disable (Module disables on high or open)	13	RX DATA OUT+	Receiver Data Out
4	MOD-DFE2	Modulation Definition 2 – Two wires serial ID Interface	14	RX GND	Receiver Ground
5	MOD-DEF1	Modulation Definition 1 – Two wires serial ID Interface	15	Vcc RX	Receiver Power – 3.3V±5%
6	MOD-DEF0	Modulation Definition 0 – Ground in Module	16	Vcc TX	Transmitter Power – 3.3V±5%
7	N/C	Not Connected	17	TX GND	Transmitter Ground
8	LOS	Loss of Signal	18	TX DATA IN+	Transmitter Data In
9	RX GND	Receiver Ground	19	TX DATA IN-	Inverse Transmitter Data In
10	RX GND	Receiver Ground	20	TX GND	Transmitter Ground

MODULE DEFINITION

Module Definition	MOD-DEF2 PIN 4	MOD-DEF1 PIN 5	MOD-DEF0 PIN 6	Interpretation by Host
4	SDA	SCL	LV-TTL Low	Serial module definition protocol

Module Definition 4 specifies a serial definition protocol. For this definition, upon power up, MOD-DEF(1:2) appear as no connector (NC) and MOD-DEF(0) is TTL LOW. When the host system detects this condition, it activates the serial protocol. The protocol uses the 2-wire serial CMOS E²PROM protocol of the ATMEL AT24C01A/02/04 family of components.

RECOMMENDED CIRCUIT SCHEMATIC

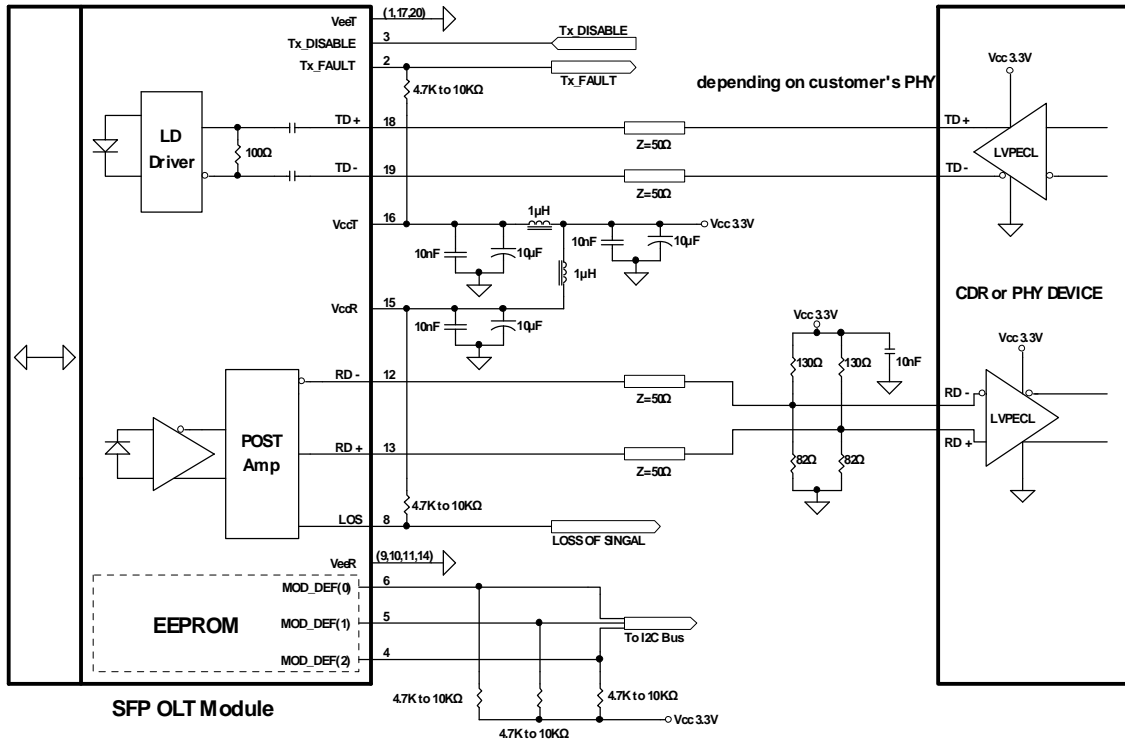

PACKAGE DIAGRAM

Units in mm

Top View

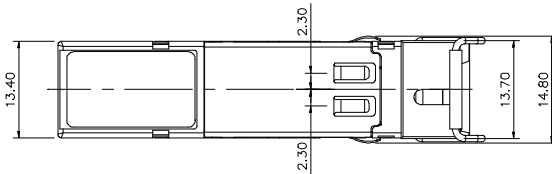

Front View

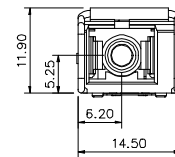
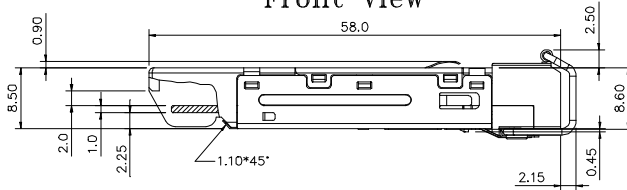

Side View

Bottom View

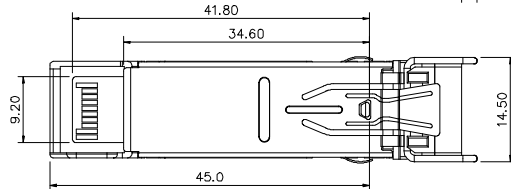

Note: Specifications subject to change without notice.