

### General Description

The AAT3128 is a total solution controller for RGB LED fashion lighting. A simplified control scheme greatly reduces design complexity and accelerates time to market.

The AAT3128 contains a high efficiency tri-mode charge pump DC/DC converter with 1X, 1.5X and 2X modes for color LED applications. Current source outputs drive two individual RGB LEDs for color displays, fashion and mood lighting. With a single-wire S<sup>2</sup>Cwire interface, an RGB LED module is easily controlled to display four distinct lighting mood effects.

Low external parts count (two 1μF flying capacitors and two small bypass capacitors) and high conversion efficiency make the AAT3128 ideally suited for small battery-powered portable applications.

The AAT3128 has a thermal management system to protect the device in the event of an output short circuit condition. Built-in soft-start circuitry prevents excessive inrush current during start-up. A low current shutdown feature disconnects the load from the input source and reduces quiescent current to less than 1μA.

The AAT3128 is available in a 14-pin TSOPJW package.

### Features

- 2.7V to 5.5V Input Voltage Range
- Compatible with Common Anode RGB LEDs
- Four S<sup>2</sup>Cwire Controlled Lighting Moods
- 0~60mA Programmable Current Source
- Low Noise Constant Frequency Operation
- No Inductors
- Small Application Circuit
- Regulated Output Current
- Integrated LED Control Switches
- Automatic Soft-Start
- Less than 1μA Shutdown Current

### Applications

- Color Backlighting for Monochrome LCD Displays
- Color Display Lighting
- Fashion Lighting RGB LEDs
- Mobile Handsets
- MP3 Players
- PDAs
- Smart Phones

### Typical Application

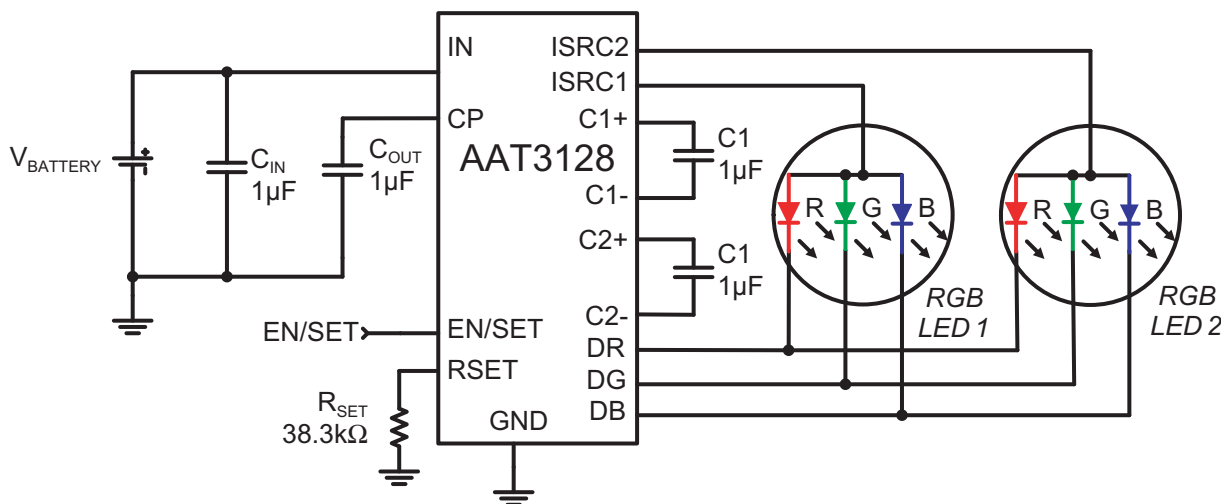

### Pin Descriptions

Pin #	Symbol	Function
1	RSET	Current Setting Resistor. Connect a resistor from RSET to GND to program the maximum LED current
2	DG	Green LED On/Off Switch. DG turns on/off the green LED. Connect the green LED cathode to DG.
3	DR	Red LED On/Off Switch. DR turns on/off the red LED. Connect the red LED cathode to DR.
4	DB	Blue LED On/Off Switch. DB turns on/off the blue LED. Connect the blue LED cathode to DB.
5	GND	Ground
6	IN	Power Input. Connect the input power voltage source to IN. Connect a 1 $\mu$ F ceramic capacitor from IN to GND.
7	C2-	Flying Capacitor 2 Negative Node. Connect a 1 $\mu$ F ceramic capacitor between C2+ and C2-.
8	C2+	Flying Capacitor 2 Positive Node. Connect a 1 $\mu$ F ceramic capacitor between C2+ and C2-.
9	C1-	Flying Capacitor 1 Negative Node. Connect a 1 $\mu$ F ceramic capacitor between C1+ and C1-.
10	C1+	Flying Capacitor 1 Positive Node. Connect a 1 $\mu$ F ceramic capacitor between C1+ and C1-.
11	CP	Charge Pump Output. CP is the output voltage stage of the internal charge pump. Bypass CP to GND with a 1 $\mu$ F ceramic capacitor.
12	ISRC1	LED Current Source 1. ISRC1 controls the current through the LEDs connected to it. Connect the RGB LED anode or LED array anodes to ISRC1.
13	ISRC2	LED Current Source 2. ISRC2 controls the current through the LEDs connected to it. Connect the RGB LED anode or LED array anodes to ISRC2.
14	EN/SET	Enable/Set Input. ENSET turns on/off the AAT3128 and is the S <sup>2</sup> Cwire serial interface input to control the LED color and brightness mood function. This node uses active high logic.

### Pin Configuration

**TSOPJW-14**  
(Top View)

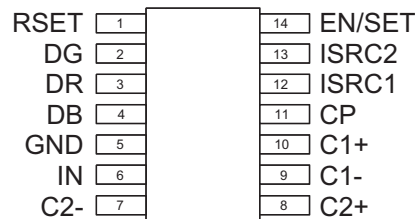

### Absolute Maximum Ratings<sup>1</sup>

Symbol	Description	Value	Units
$V_{IN}, V_{CP}$	IN, CP to GND	-0.3 to 6	V
$V_{C1+}, V_{C1-}, V_{C2+}, V_{C2-}$	C1+, C1-, C2+, C2- to GND	-0.3 to $V_{CP} + 0.3$	V
$V_{EN/SET}, V_{RSET}, V_{ISRC1}, V_{ISRC2}, V_{DG}, V_{DR}, V_{DB}$	EN/SET, RSET, ISRC1, ISRC2, DG, DR, DB to GND	-0.3 to $V_{IN} + 0.3$	V
$T_J$	Operating Junction Temperature Range	-40 to 150	°C
$T_{LEAD}$	Maximum Soldering Temperature (at leads, 10 sec)	300	°C

### Thermal Characteristics

Symbol	Description	Value	Units
$\Theta_{JA}$	Maximum Thermal Resistance <sup>2</sup>	160	°C/W
$P_D$	Maximum Power Dissipation <sup>2</sup>	625	mW

1. Stresses above those listed in Absolute Maximum Ratings may cause permanent damage to the device. Functional operation at conditions other than the operating conditions specified is not implied. Only one Absolute Maximum Rating should be applied at any one time.  
 2. Mounted on a FR4 board.

### Electrical Characteristics

$V_{IN} = 3.6V$ ,  $C_{IN} = C_{OUT} = C1 = C2 = 1.0\mu F$ ;  $T_A = -40$  to  $+85^\circ C$ . Unless otherwise noted, typical values are  $T_A = 25^\circ C$

Symbol	Description	Conditions	Min	Typ	Max	Units
<b>Input Power Supply</b>						
$V_{IN}$	Input Operation Range		2.7		5.5	V
$I_{CC}$	Operating Current	$3.0 \leq V_{IN} \leq 5.5$ , $C_P = 1.5x$ , No Load Current		3	7	mA
$I_{SHDN}$	Shutdown Current	EN = 0			10	$\mu A$
$I_{SRC}$	Output Current Accuracy	$3.0 \leq V_{IN} \leq 5.5$	-5		5	%
$\eta$	Efficiency	$V_{IN} = 3.5$		93		%
<b>Charge Pump</b>						
$T_{SS}$	Soft-Start Time			200		$\mu s$
$F_{CLK}$	Clock Frequency			1		MHz
$\eta$	Efficiency	$V_{IN} = 3.5$		93		%
<b>Switches</b>						
$R_{DS(ON)}$	Switch On Resistance	$V_{IN} = 3.5$ , $T_A = 25^\circ C$		2		$\Omega$
<b>EN/SET</b>						
$V_{EN(L)}$	Enable Threshold Low				0.4	V
$V_{EN(H)}$	Enable Threshold High		1.4			V
$T_{EN/SET LO}$	EN/SET Low Time	$V_{EN/SET} < 0.6V$	0.3		75	$\mu s$
$T_{EN/SET HI}$	Minimum EN/SET High Time	$V_{EN/SET} > 1.4V$		50		ns
$T_{OFF}$	EN/SET Off Timeout	$V_{EN/SET} < 0.6V$			500	$\mu s$
$T_{LAT}$	EN/SET Latch Timeout	$V_{EN/SET} > 1.4V$			500	$\mu s$
$I_{EN/SET}$	EN/SET Input Leakage	$V_{EN/SET} = 5V$	-1		1	$\mu A$

1. The AAT3128 is guaranteed to meet performance specification over the  $-40$  to  $+85^\circ C$  operating temperature range, and are assured by design, characterization and correlation with statistical process controls.

### Typical Characteristics

**Current Source Output vs. Input Voltage**

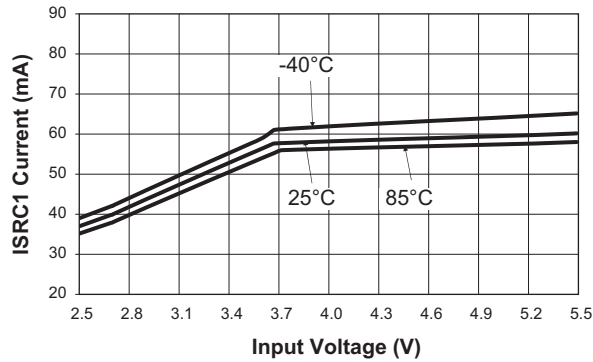

**Shutdown Current vs. Input Voltage**

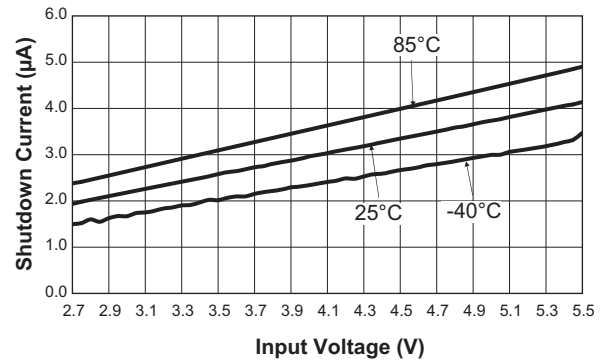

**Enable Input High Threshold vs. Input Voltage**

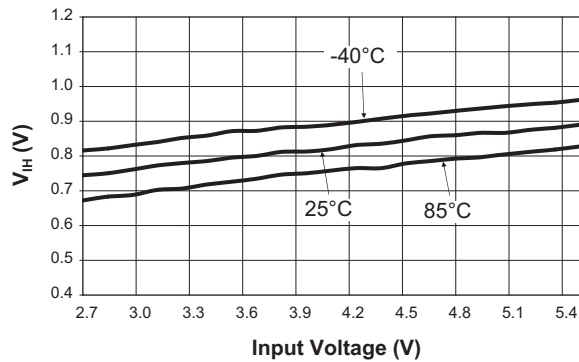

**Enable Input Low Threshold vs. Input Voltage**

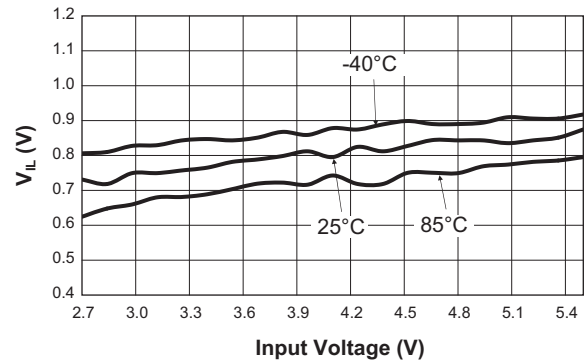

**EN/SET Turn-Off Time vs. Input Voltage**

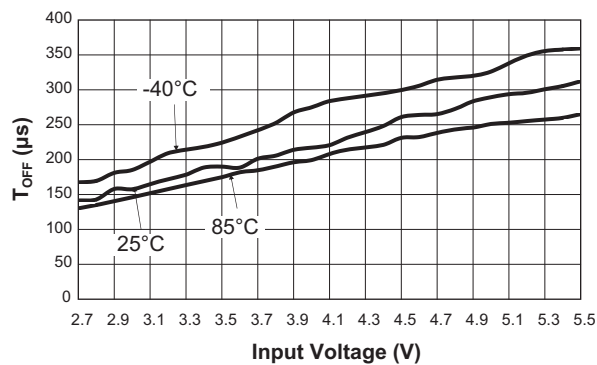

**S<sup>2</sup>Cwire Latch Enable Time vs. Input Voltage**

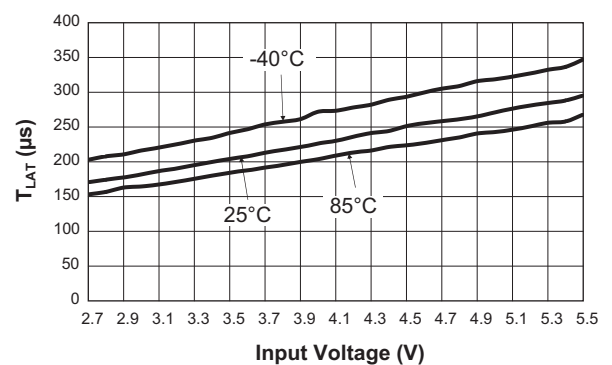

**Typical Characteristics**

**Input vs. Output Transient**  
( $V_{IN} = 2.7V$ ; Data 1)

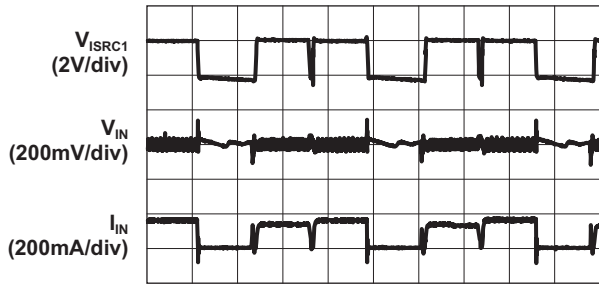

Time (500µs/div)

**Input vs. Output Transient**  
( $V_{IN} = 2.7V$ ; Data 5)

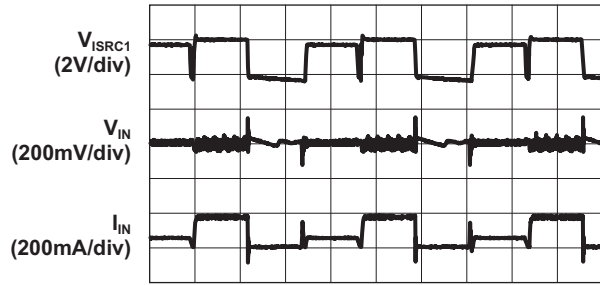

Time (500µs/div)

**Input vs. Output Transient**  
( $V_{IN} = 3.6V$ ; Data 1)

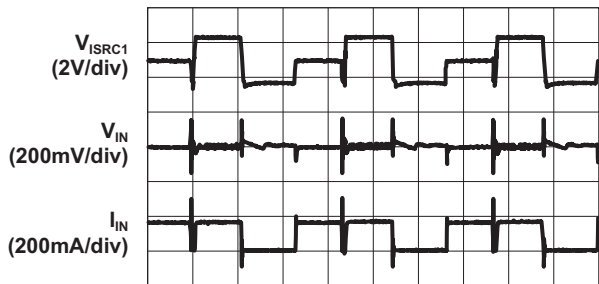

Time (500µs/div)

**Input vs. Output Transient**  
( $V_{IN} = 3.6V$ ; Data 5)

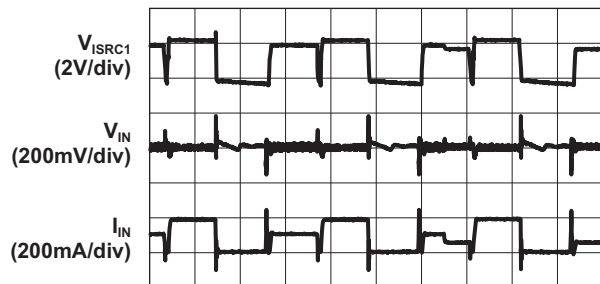

Time (500µs/div)

**Input vs. Output Transient**  
( $V_{IN} = 4.2V$ ; Data 1)

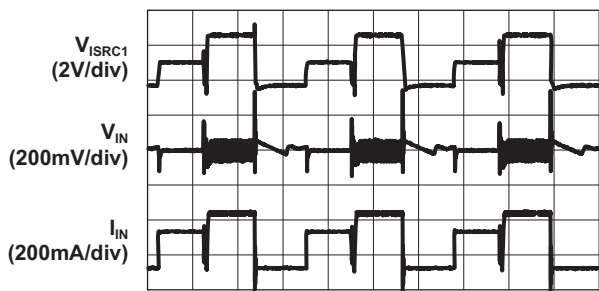

Time (500µs/div)

**Input vs. Output Transient**  
( $V_{IN} = 4.2V$ ; Data 5)

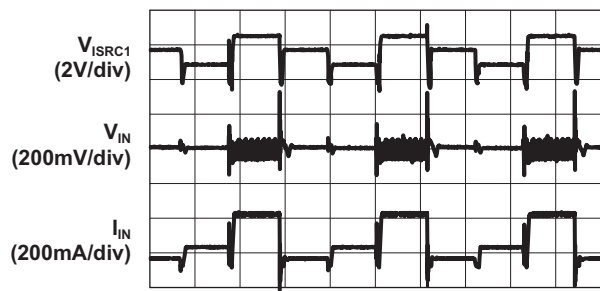

Time (500µs/div)

### Functional Block Diagram

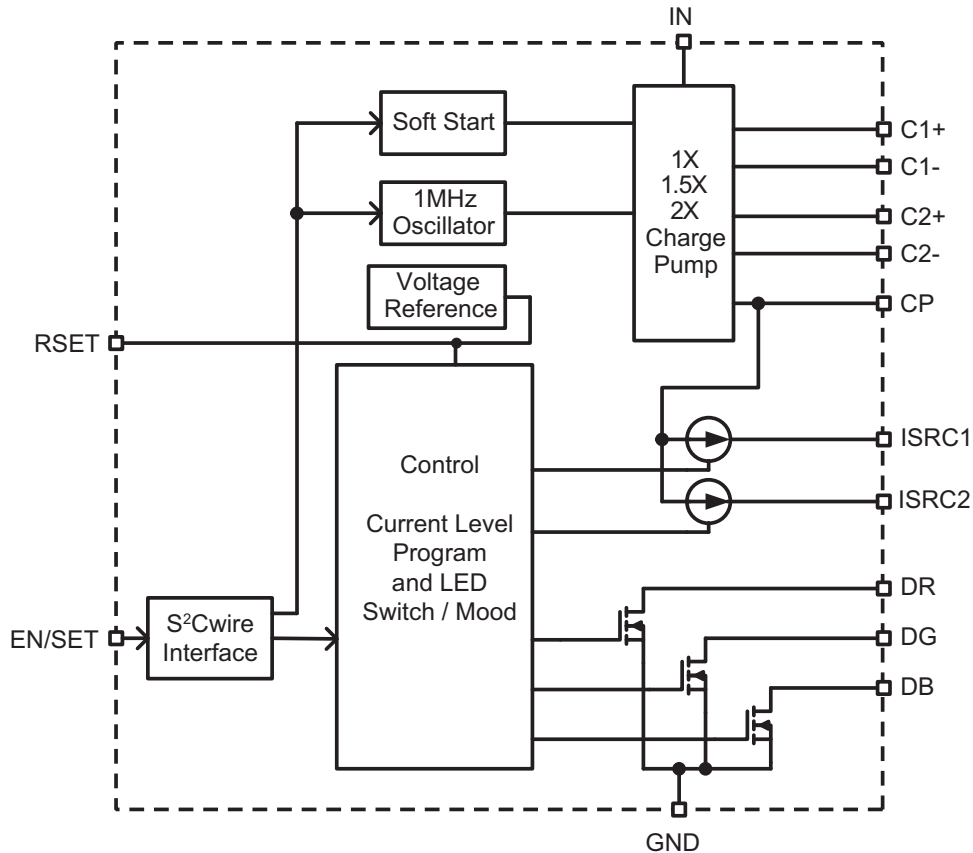

### Functional Description

The AAT3128 is specifically designed to drive RGB color LEDs. This device is externally programmed via the simple single wire serial S<sup>2</sup>Cwire interface to set one of 16 color lighting modes based on four distinct preset color light mood schemes. In addition to the four color lighting moods, there are two brightness levels and two lightning sequence change speeds that may be selected.

The AAT3128 utilizes a tri mode load switch (1X) and high efficiency (1.5X or 2X) charge pump boost converter intended for RGB color LED lighting applications. To maximize power conversion efficiency, an internal sensing circuit monitors the voltage required for the constant current source outputs and sets the load switch or charge pump modes based on the input battery voltage. As the battery discharges over time, the AAT3128 charge pump is

enabled when the current source outputs near dropout. The charge pump initially starts in 1.5X mode. If the charge pump output droops enough for the current source output to become close to dropout, the charge pump will automatically transition to 2X mode. This load switch to charge pump control system provides the maximum power conversion efficiency for any given operating condition.

The AAT3128 requires only four external components: two 1 $\mu$ F ceramic capacitors for the charge pump flying capacitors (C1 and C2), one 1 $\mu$ F ceramic input capacitor (C<sub>IN</sub>) and one 1 $\mu$ F ceramic output capacitor (C<sub>P</sub>).

### RGB LED Lighting Set-Up and Control

The AAT3128 has four preset RGB LED color lighting moods which may be selected via the EN/SET function. These four lighting color moods are outlined in Table 1. Each lighting color mood mode

selects a preset group of 64 unique colors that the system controller repeatedly sequences through at a selected fast or slow rate.

RGB LED brightness and color change timing may be varied by a choice of two levels for both. The Brightness control permits the full current to power the RGB LED based on the current set level programmed by the  $R_{SET}$  resistor. The second dimming level is fixed at 6dB below that programmed by the  $R_{SET}$  resistor. The pace of the color change for a given mood light option can be set to a fast or slow rate.

Through the S<sup>2</sup>Cwire interface, mood options allow the user to select between four different moods, each with two brightness levels and two speeds, based on the number of rising edges of the EN/SET pin. 16 unique moods are selected based on the settings in Table 2.

### EN/SET Serial Interface

The lighting mood output is controlled by the EN/SET pin, using AnalogicTech’s Simple Serial Control™ (S<sup>2</sup>Cwire) interface. The interface records rising edges of the EN/SET pin, and decodes them into 16 individual settings based on an internal pre-

set ROM table. The interface counter can be clocked at speeds up to 1MHz. The rising edges of EN/SET input enable the IC and are counted for 1 to 16 edges based on the desired mode. Once the final clock cycle is input for the desired mode the EN/SET pin is held high to enable the device output. The device is disabled 500µs after the EN/SET pin transitions to a logic low state.

The EN/SET timing is designed to accommodate a wide range of data rates. After the first rising edge of EN/SET, the charge pump is enabled and reaches full capacity after the soft-start time ( $T_{SS}$ ). During the soft start time, multiple clock pulses may be entered on the EN/SET pin to set the final output current level with a single burst of clocks. A constant current is sourced and the programmed color mood is enabled as long as EN/SET remains in a logic high state. The current source outputs are switched off after EN/SET has remained in a low state for at least the  $T_{OFF}$  time-out period. After the  $T_{OFF}$  time out time, all internal registers are reset and the charge pump is disabled.

It is advisable to issue a 500µs low pulse to reset the data registers before send new sets of data to change lighting modes. This will avoid any possibility of losing synchronization between the AAT3128 and the system MCU.

Mood	Name	Color Description
M1	Rainbow 1	Full color wheel control with continuous smooth transitions
M2	Electric Beat	Pulsing Blue – White – Red color tones
M3	Rainbow 2	Full color wheel control with varied timing for transitions
M4	Firelight	Red-Orange-Yellow flickering light

**Table 1: Programmable RGB LED Color Lighting “Moods.”**

Data	Bright/Dim	Fast/Slow	Mood
1	B	F	M1
2	B	F	M2
3	B	F	M3
4	B	F	M4
5	B	S	M1
6	B	S	M2
7	B	S	M3
8	B	S	M4
9	D	F	M1
10	D	F	M2
11	D	F	M3
12	D	F	M4
13	D	S	M1
14	D	S	M2
15	D	S	M3
16	D	S	M4

**Table 2: AAT3128 S<sup>2</sup>Cwire Programming Modes.**



### EN/SET Timing

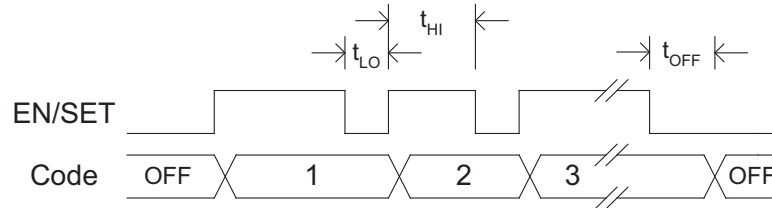

Figure 1: S<sup>2</sup>Cwire Timing Diagram.

## Application Information

### R<sub>SET</sub> Selection

The maximum output current for current sources ISRC1 and ISRC2 is programmed by the R<sub>SET</sub> resistor. A nominal value of 38.3kΩ will set each current source output to 60mA each. Lower maximum current levels may be programmed by reducing the value of R<sub>SET</sub>. Refer to Table 3 for R<sub>SET</sub> resistor values to set the maximum brightness constant current rounded off to the closest 1% value.

Current Source Output (mA)	R <sub>SET</sub> Value (kΩ)
60	38.3
50	46.6
40	57.6
30	76.8
20	115
10	232

Table 3: R<sub>SET</sub> Programming Values.

If a desired current source output level is not listed in Table 3, the R<sub>SET</sub> resistor value may be calculated using the following formula:

$$R_{SET} = \frac{(1920 \cdot V_{REF})}{I_{OUT}}$$

Where:

$$V_{REF} = 1.2V$$

$I_{OUT}$  = Desired output current for ISRC1 and ISRC2 (ISRC1 = ISRC2 ≤ 60mA)

### RGB LED Selection

The AAT3128 is specifically intended for driving RGB color LEDs. However, the device design will allow the AAT3128 to drive most types of LEDs with forward voltage specifications ranging from 1.0V to 5.0V. The two current sink outputs provide up to 60mA each and may be paralleled to drive high-current LEDs up to 120mA without complication.

Most RGB color LEDs have greatly varied forward voltage specifications for each red, green and blue LED for a given forward current operating condition. Refer to Figure 2 or the datasheet for a given RGB LED to be used with the AAT3128. Since the ISRC1 and ISRC2 output current sources are matched with negligible voltage dependence, RGB LED brightness and color will be matched regardless of specific LED forward voltage ( $V_F$ ) variations.

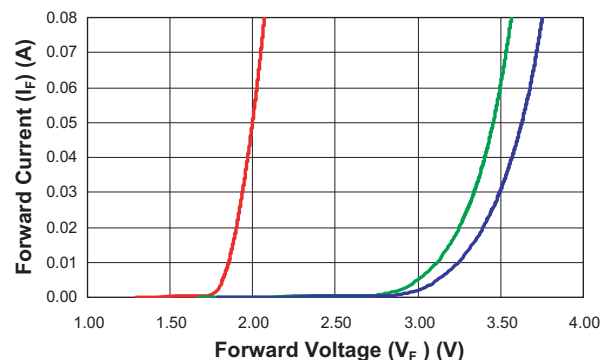

Figure 2: Typical RGB LED Forward Voltage vs. Forward Current Characteristics.

## Capacitor Selection

Careful selection of the four external capacitors  $C_{IN}$ ,  $C_1$ ,  $C_2$ , and  $C_{OUT}$  is important because they will affect turn-on time, output ripple, and transient performance. Optimum performance will be obtained when low equivalent series resistance (ESR) ceramic capacitors are used. In general, low ESR may be defined as less than  $50\text{m}\Omega$ . For best overall performance,  $1\mu\text{F}$  capacitors are recommended.

Depending on ripple requirements, the input and output capacitor values can be increased or decreased accordingly. If lower ripple is desired, increase the capacitor value. The peak-to-peak ripple seen at the input or output increases or decreases with capacitor size.

## Capacitor Characteristics

Ceramic composition capacitors are highly recommended over all other types of capacitors for use with the AAT3128. Ceramic capacitors offer many advantages over their tantalum and aluminum electrolytic counterparts. A ceramic capacitor typically has very low ESR, is lowest cost, has a smaller PCB footprint, and is non-polarized. Low ESR ceramic capacitors help maximize charge pump transient response. Since ceramic capacitors are non-polarized, they are not prone to incorrect connection damage.

## Equivalent Series Resistance

ESR is an important characteristic to consider when selecting a capacitor. ESR is a resistance internal to a capacitor that is caused by the leads, internal connections, size or area, material composition, and ambient temperature. Capacitor ESR is typically measured in milliohms for ceramic capacitors and can range to more than several ohms for tantalum or aluminum electrolytic capacitors.

## Ceramic Capacitor Materials

Capacitors used in AAT3128 applications range in value from  $0.47\mu\text{F}$  to  $2.2\mu\text{F}$ . Nominally a  $1\mu\text{F}$  capacitor with a minimum voltage specification exceeding 6V is recommended. Ceramic capacitors in this range are typically composed of X7R, X5R, Z5U, or Y5V dielectric materials. The use of X5R and X7R dielectric capacitors is strongly recommended due to their inherent low ESR characteristics and improved tolerance specifications over the device operating temperature range.

Capacitors that are physically larger will have a lower ESR when compared to a smaller case size capacitor made from an equivalent material. These larger devices can improve circuit transient response when compared to an equal value capacitor in a smaller package size.

## Layout Considerations

The AAT3128 is a high-performance device that operates with a high switching frequency. To ensure optimal device performance and accommodate the fast switched capacitor transients generated by the AAT3128, special attention should be given to the printed circuit board (PCB) layout. The PCB traces connecting  $C_1$  and  $C_2$  experience fast current transients. As a result, the trace lengths for  $C_1$  and  $C_2$  should be minimized by placing the components as closely as possible to the IC. This will minimize path resistance and reduce ringing due to the inductance associated with trace length. For best IC performance,  $C_{IN}$  and  $C_{OUT}$  are placed as closely as possible to the IN and CP pins and are connected to a solid ground.

**AAT3128 Evaluation Board Layout**

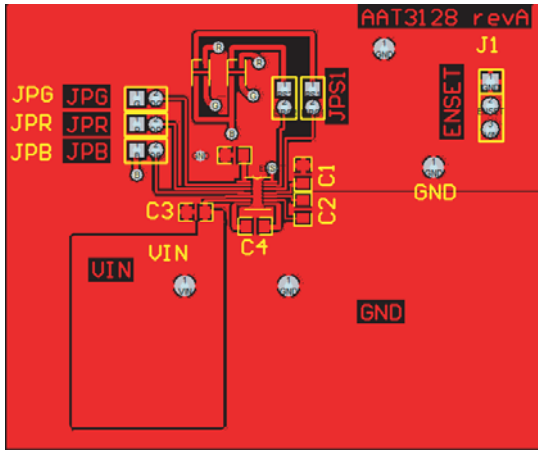

Figure 3: AAT3128 Evaluation Board Component Side PCB Layout.

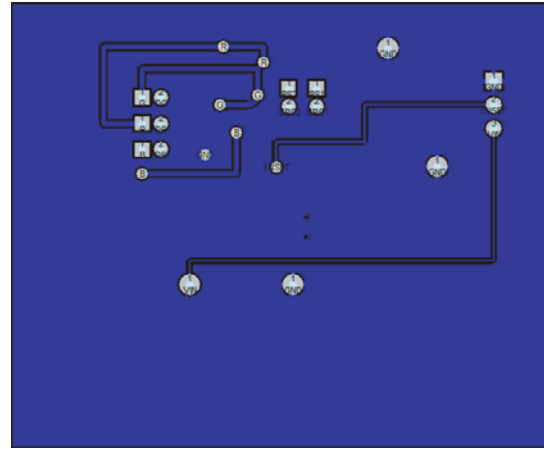

Figure 4: AAT3128 Evaluation Board Solder Side PCB Layout.

### Ordering Information

Package	Marking <sup>1</sup>	Part Number (Tape and Reel) <sup>2</sup>
TSOPJW-14	VMXY	AAT3128ITO-T1



All AnalogicTech products are offered in Pb-free packaging. The term “Pb-free” means semiconductor products that are in compliance with current RoHS standards, including the requirement that lead not exceed 0.1% by weight in homogeneous materials. For more information, please visit our website at <http://www.analogictech.com/pbfree>.

### Package Information

#### TSOPJW-14

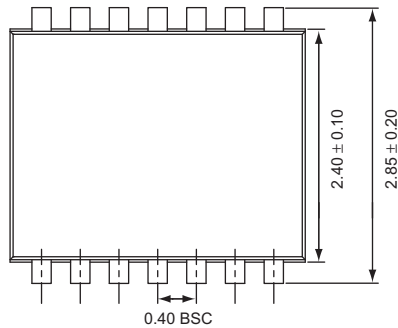

Top View

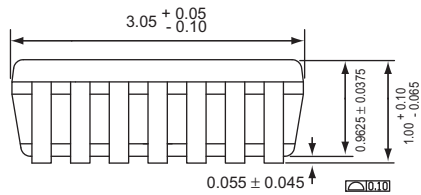

Side View

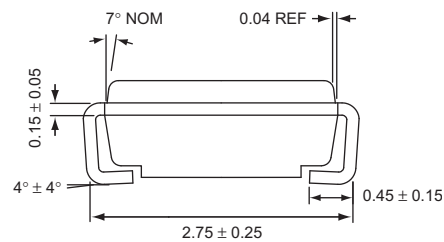

End View

All dimensions in millimeters.

1. XYY = assembly and date code.  
 2. Sample stock is generally held on part numbers listed in **BOLD**.

© Advanced Analogic Technologies, Inc.

AnalogicTech cannot assume responsibility for use of any circuitry other than circuitry entirely embodied in an AnalogicTech product. No circuit patent licenses, copyrights, mask work rights, or other intellectual property rights are implied. AnalogicTech reserves the right to make changes to their products or specifications or to discontinue any product or service without notice. Except as provided in AnalogicTech's terms and conditions of sale, AnalogicTech assumes no liability whatsoever, and AnalogicTech disclaims any express or implied warranty relating to the sale and/or use of AnalogicTech products including liability or warranties relating to fitness for a particular purpose, merchantability, or infringement of any patent, copyright or other intellectual property right. In order to minimize risks associated with the customer's applications, adequate design and operating safeguards must be provided by the customer to minimize inherent or procedural hazards. Testing and other quality control techniques are utilized to the extent AnalogicTech deems necessary to support this warranty. Specific testing of all parameters of each device is not necessarily performed. AnalogicTech and the AnalogicTech logo are trademarks of Advanced Analogic Technologies Incorporated. All other brand and product names appearing in this document are registered trademarks or trademarks of their respective holders.

**Advanced Analogic Technologies, Inc.**  
**3230 Scott Boulevard, Santa Clara, CA 95054**  
**Phone (408) 737-4600**  
**Fax (408) 737-4611**