

TOSHIBA Bipolar Linear Integrated Circuit Silicon Monolithic

TA48LS00F

300 mA Output Current, Variable Output Voltage and Low Dropout Voltage Regulator with ON/OFF Control Switch

The TA48LS00F consists of small-surface mount type low-dropout regulators with an output current of 300mA (maximum) and an ON/OFF control switch. Control by an EN (ON/OFF) terminal enables the regulator to be operated only when required (output ON). The output voltage can be arbitrarily set by external resistance. Therefore, the TA48LS00F can be used for a wide range of applications. TA48LS00F is suitable for use in the power supply circuits of AV, OA and other digital devices equipped with a stand-by function, and of battery-operated portable data devices of various types, where they will contribute to energy saving.

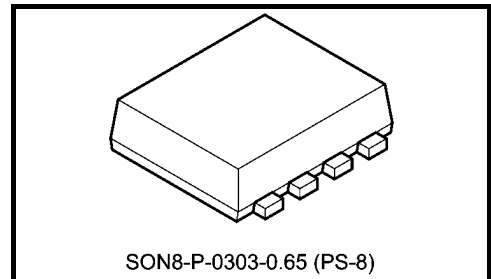

SON8-P-0303-0.65 (PS-8)

Weight : 0.08 g (Typ.)

Features

- Built-in ON/OFF control function (active high)
- Maximum output current : 300 mA
- Output voltage : $V_{OUT} = 1.5 \sim 5.0$ V
- Reference voltage accuracy : $V_{REF} \pm 2.3\%$ (@ $T_j = 25^\circ\text{C}$)
- Low quiescent current : 1 mA (Typ.) (@ $I_{OUT} = 0$ A)
- Low standby current (output OFF mode): 0.2 μ A (Typ.)
- Low-dropout voltage : 0.5 V (Max) (@ $V_{OUT} = 3.3$ V, $I_{OUT} = 150$ m A)
- Protection function : Over current protection / thermal shutdown
- Package type : PS-8

Pin Assignment

Product No.	Marking
TA48LS00F	LS00

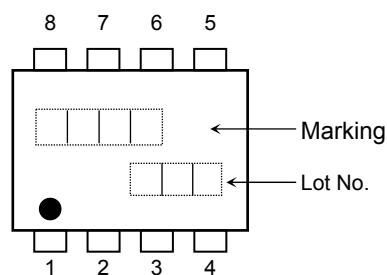

- 1 : N.C.
- 2~4 : GND
- 5 : IN
- 6 : EN
- 7 : ADJ
- 8 : OUT

* Weekly code: (Three digits)

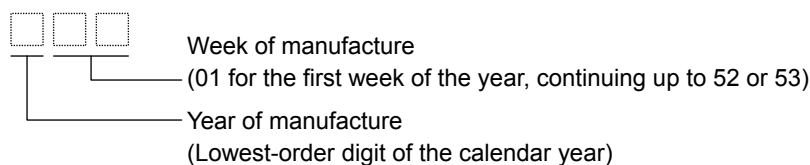

Pin Description

Pin No.	Symbol	Description
1	N.C.	Non-connection
2~4	GND	Ground terminal
5	IN	Input terminal. Connected by capacitor (C_{IN}) to GND.
6	EN	Output ON/OFF control terminal. Output is ON when this pin is set to "High", OFF when this pin is open or set to "Low".
7	ADJ	Output voltage feedback to regulator. It is connected to an error amplifier with $V_{REF}=1.238\text{ V}$ (Typ.).
8	OUT	Output terminal. Connected by capacitor (C_{OUT}) to GND.

How to Order

Product No.	Package Type and Capacity
TA48LS00F(TE85L, F)	Tape (3000 pcs/reel)

Block Diagram

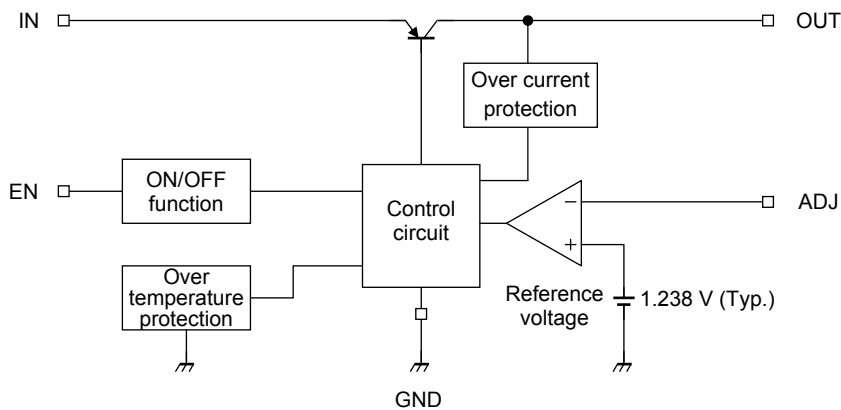

Absolute Maximum Rating (Ta = 25°C)

Characteristic	Symbol	Rating	Unit
Input voltage	V _{IN}	14	V
EN Input voltage	V _{EN}	14	V
Output current	I _{OUT}	300	mA
Operating junction temperature	T _{j(opr)}	-40~150	°C
Junction temperature	T _j	150	°C
Storage temperature	T _{stg}	-55~150	°C
Power dissipation (Note 3)	Ta = 25°C P _D	1.2	W

Note 1: Do not apply current and voltage (including reverse polarity) to any pin that is not specified.

Note 2: Using continuously under heavy loads (e.g. the application of high temperature/current/voltage and the significant change in temperature, etc.) may cause this product to decrease in the reliability significantly even if the operating conditions (i.e. operating temperature/current/voltage, etc.) are within the absolute maximum ratings and the operating ranges.

Please design the appropriate reliability upon reviewing the Toshiba Semiconductor Reliability Handbook ("Handling Precautions"/Derating Concept and Methods) and individual reliability data (i.e. reliability test report and estimated failure rate, etc).

Thermal Characteristics

Characteristic	Symbol	Max	Unit
Thermal resistance, junction to ambient	R _{th(j-a)}	102	°C/W

Note 3: Glass epoxy board

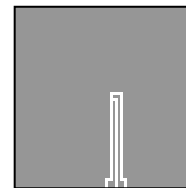

Material :FR-4
25.4 × 25.4 × 1.6
Unit : (mm)
Cu base thickness : 35 μm

Operating Input Voltage Range

Characteristic	Symbol	Min	Typ.	Max	Unit
Input voltage	V _{IN}	2.5(Note 4)	—	14.0	V

Note 4: This is the voltage at which the IC begins operating. V_D must be considered when determining the best input voltage for the application.

Output Voltage Range

Characteristic	Symbol	Min	Typ.	Max	Unit
Output voltage	V _{OUT}	1.5	—	5.0	V

Protection Function (Reference)

Characteristic	Symbol	Test Condition	Min	Typ.	Max	Unit
Thermal shutdown	T _{SD}	V _{IN} = 4.3 V	150	170	—	°C
Thermal shutdown hysteresis width	T _{SD(hys)}		—	15	—	°C
Peak circuit current	I _{PEAK}	V _{IN} = 5.3 V, T _j = 25°C	300	500	—	mA
		V _{IN} = 8.3 V, T _j = 25°C	300	500	—	
Short circuit current	I _{SC}	V _{IN} = 5.3 V, T _j = 25°C	—	300	—	mA
		V _{IN} = 16V, T _j = 25°C	—	300	—	

Note 5: Ensure that the devices operate within the limits of the maximum rating when in actual use.

TA48LS00F

Electrical Characteristics

(Unless otherwise specified, $V_{EN} = V_{IN}$, $V_{OUT} = 3.3\text{ V}$, $C_{IN} = 0.33\ \mu\text{F}$, $C_{OUT} = 1\ \mu\text{F}$, $T_j = 25^\circ\text{C}$)

Characteristic	Symbol	Test Condition	Min	Typ.	Max	Unit
Reference voltage	V_{REF}	$V_{IN} = 5.3\text{ V}$, $I_{OUT} = 150\text{ mA}$	1.209	1.238	1.267	V
Line regulation	Reg·line	$4.3\text{ V} \leq V_{IN} \leq 8.3\text{ V}$, $I_{OUT} = 150\text{ mA}$	—	2	20	mV
Load regulation	Reg·load	$V_{IN} = 5.3\text{ V}$, $5\text{ mA} \leq I_{OUT} \leq 300\text{ mA}$	—	3	20	mV
Quiescent current	I_B	$4.3\text{ V} \leq V_{IN} \leq 8.3\text{ V}$, $I_{OUT} = 0\text{ A}$	—	1.0	1.7	mA
		$4.3\text{ V} \leq V_{IN} \leq 8.3\text{ V}$, $I_{OUT} = 300\text{ mA}$	—	5	10	
Quiescent current (OFF mode)	$I_{B(OFF)}$	$4.3\text{ V} \leq V_{IN} \leq 8.3\text{ V}$, $V_{EN} = 0.4\text{ V}$	—	0.2	5.0	μA
Starting quiescent current	I_{Bstart}	$V_{IN} = 2.1\text{ V}$, $I_{OUT} = 0\text{ A}$	—	1.4	4.0	mA
		$V_{IN} = 2.8\text{ V}$, $I_{OUT} = 300\text{ mA}$	—	8.3	18.0	
Output noise voltage	V_{NO}	$V_{IN} = 5.3\text{ V}$, $I_{OUT} = 50\text{ mA}$, $10\text{ Hz} \leq f \leq 100\text{ kHz}$	—	70	—	μV_{rms}
Ripple rejection	R.R.	$V_{IN} = 5.3\text{ V}$, $I_{OUT} = 50\text{ mA}$, $f = 120\text{ Hz}$	—	60	—	dB
Dropout voltage	V_D	$I_{OUT} = 150\text{ mA}$	—	0.2	0.5	V
		$I_{OUT} = 300\text{ mA}$	—	0.3	0.6	
Output control voltage (ON)	$V_{EN(ON)}$	—	2	—	—	V
Output control voltage (OFF)	$V_{EN(OFF)}$	—	—	—	0.8	V
Output control current (ON)	$I_{EN(ON)}$	$V_{IN} = V_{EN} = 5.3\text{ V}$	—	53	75	μA
Average temperature coefficient of output voltage	T_{CVO}	$V_{IN} = 5.3\text{ V}$, $I_{OUT} = 5\text{ mA}$, $0^\circ\text{C} \leq T_j \leq 125^\circ\text{C}$	—	0.3	—	$\text{mV}/^\circ\text{C}$

Electrical Characteristics Common to All Products

- $T_j = 25^\circ\text{C}$ in the measurement conditions of each item is the standard condition when a pulse test is carried out, and any drift in the electrical characteristic due to a rise in the junction temperature of the chip may be disregarded.

Standard Application Circuit

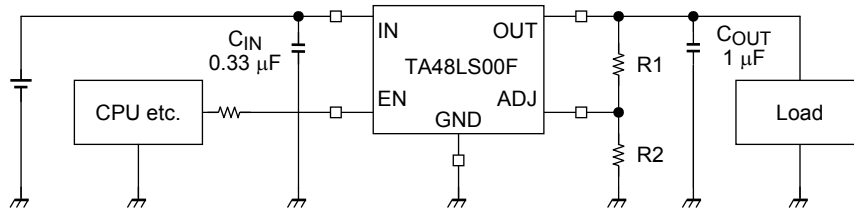

- Be sure to connect a capacitor near the input terminal and output terminal between both terminals and GND. The use of a monolithic ceramic capacitor (B Characteristic or X7R) of low ESR (equivalent series resistance) is recommended. The IC may oscillate due to external conditions (output current, temperature, or the type of the capacitor used). The type of capacitor required must be determined by the actual application circuit in which the IC is used.

Setting Output Voltage

- The output voltage is determined by the equation shown below. When you control the output voltage with R1, a recommended value to use for R2 is 5 kΩ. R1 and R2 must be placed as close as possible to each other, and the board trace to the ADJ terminal must be kept as short as possible.

$$V_{\text{OUT}} = V_{\text{REF}} \times \left(1 + \frac{R1}{R2} \right)$$

The notice in case of application

- The IC might be destroyed if a voltage greater than the input terminal voltage is applied to the output terminal, or if the input terminal is connected to GND during operation. To prevent such an occurrence, connect a diode as in the following diagram.

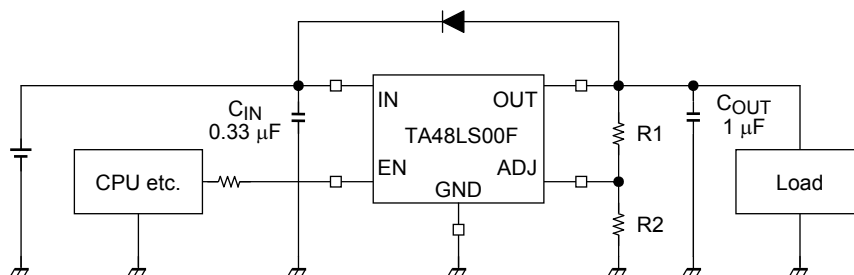

- There is a possibility that internal parasitic devices may be generated when momentary transients cause a terminal's potential to fall below that of the GND terminal. In such case, that the device could be destroyed. The voltage of each terminal and any state must therefore never fall below the GND potential.
- Depending on the load conditions, a steep increase in the input voltage applied (V_{IN}) may cause a momentary rise in output voltage (V_{OUT}) even if the EN (enable) pin is Low. Treat with care.

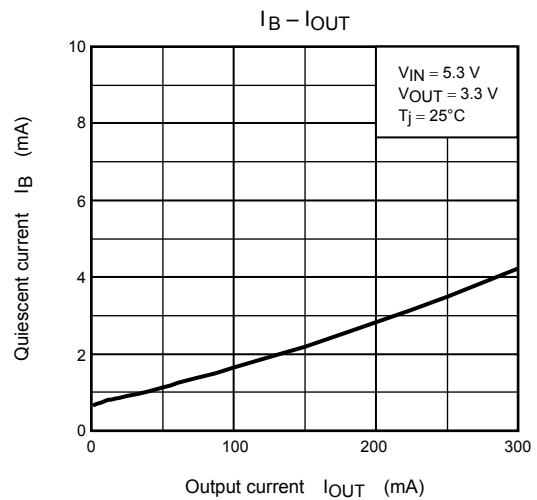
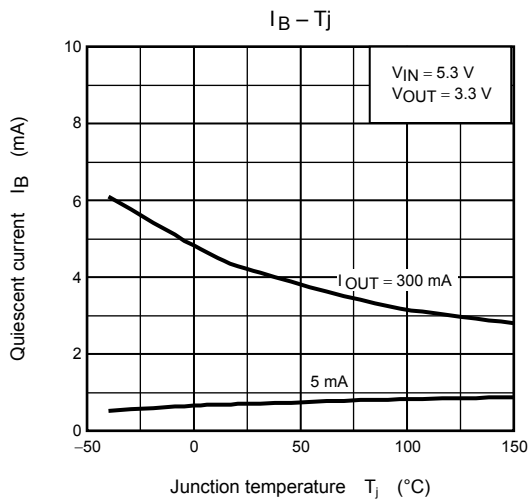
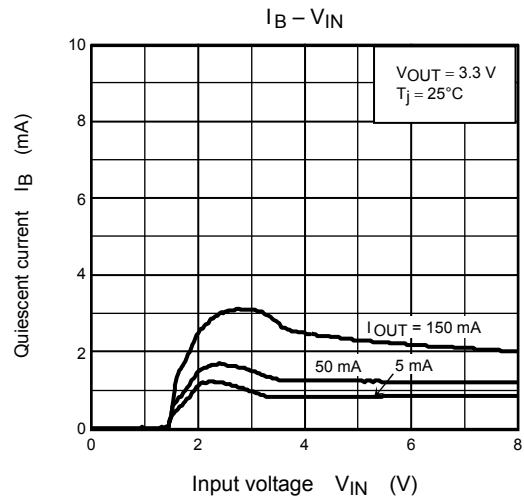
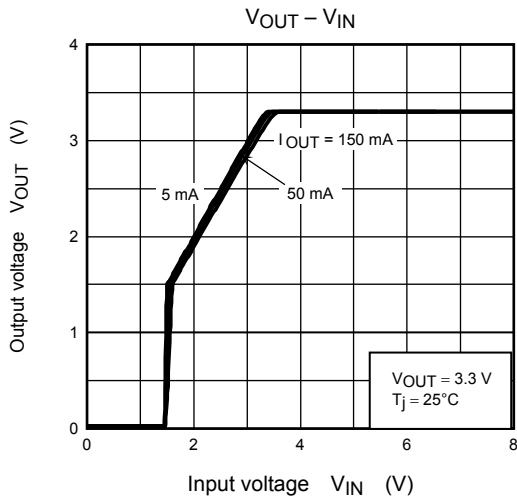
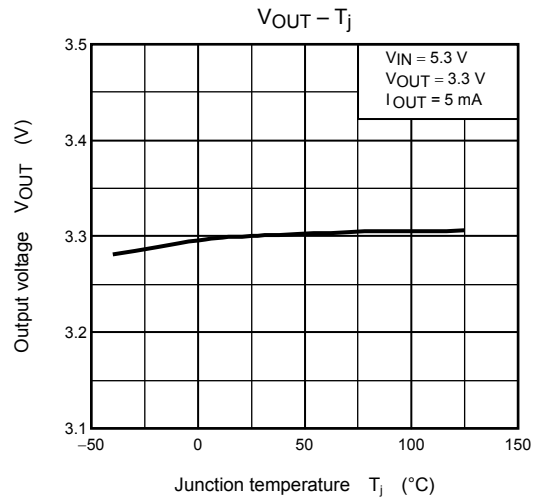
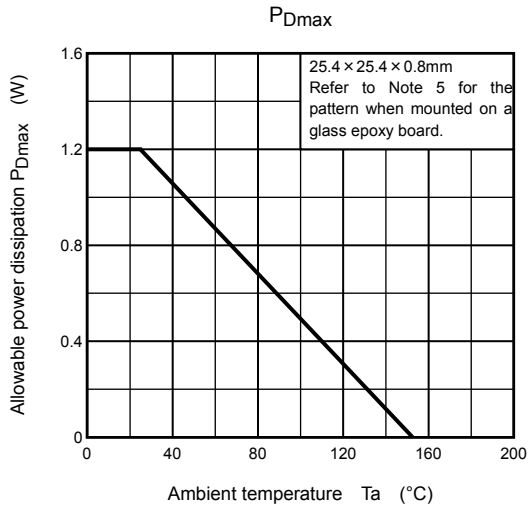

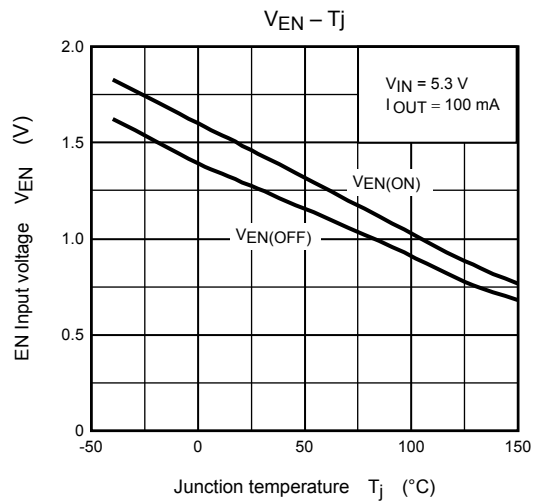
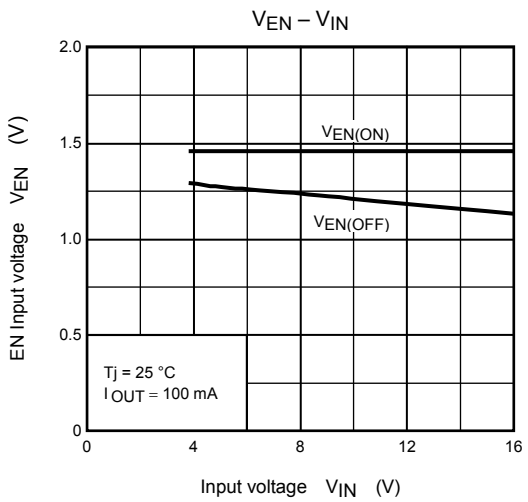
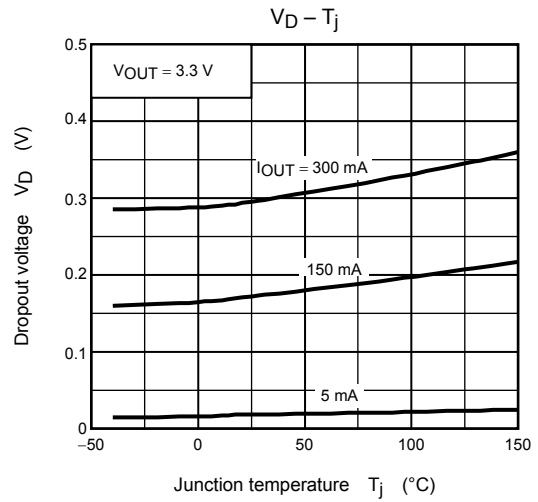
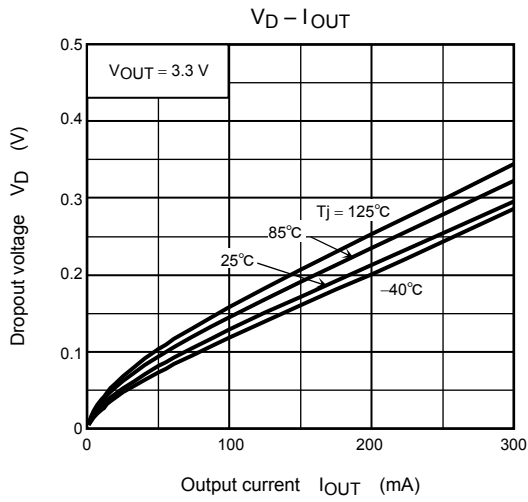
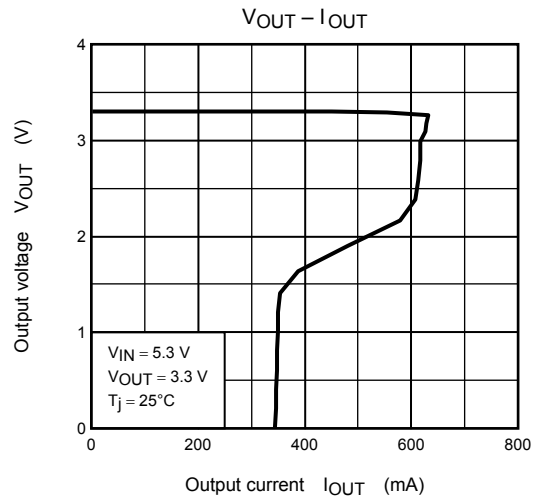
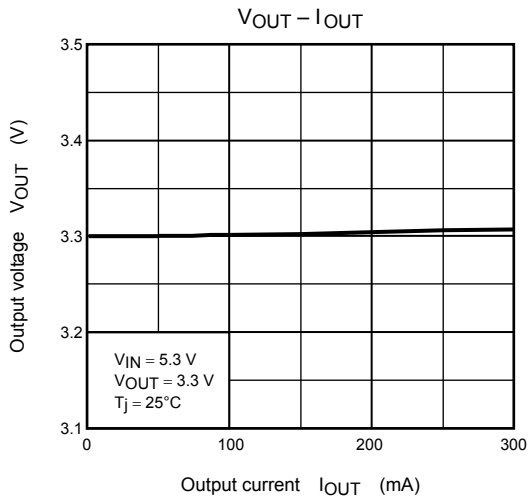

Package Dimensions

SON8-P-0303-0.65 (PS-8)

Unit: mm

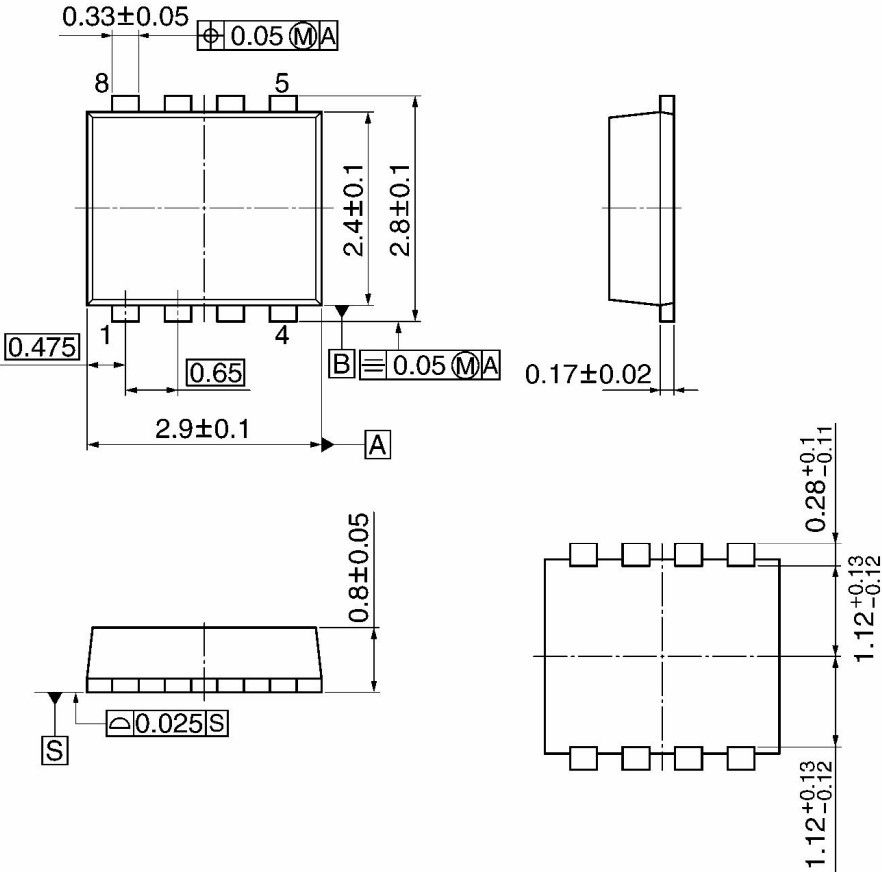

Weight: 0.08 g (Typ.)

RESTRICTIONS ON PRODUCT USE

20070701-EN

- The information contained herein is subject to change without notice.
- TOSHIBA is continually working to improve the quality and reliability of its products. Nevertheless, semiconductor devices in general can malfunction or fail due to their inherent electrical sensitivity and vulnerability to physical stress. It is the responsibility of the buyer, when utilizing TOSHIBA products, to comply with the standards of safety in making a safe design for the entire system, and to avoid situations in which a malfunction or failure of such TOSHIBA products could cause loss of human life, bodily injury or damage to property.
In developing your designs, please ensure that TOSHIBA products are used within specified operating ranges as set forth in the most recent TOSHIBA products specifications. Also, please keep in mind the precautions and conditions set forth in the "Handling Guide for Semiconductor Devices," or "TOSHIBA Semiconductor Reliability Handbook" etc.
- The TOSHIBA products listed in this document are intended for usage in general electronics applications (computer, personal equipment, office equipment, measuring equipment, industrial robotics, domestic appliances, etc.). These TOSHIBA products are neither intended nor warranted for usage in equipment that requires extraordinarily high quality and/or reliability or a malfunction or failure of which may cause loss of human life or bodily injury ("Unintended Usage"). Unintended Usage include atomic energy control instruments, airplane or spaceship instruments, transportation instruments, traffic signal instruments, combustion control instruments, medical instruments, all types of safety devices, etc.. Unintended Usage of TOSHIBA products listed in this document shall be made at the customer's own risk.
- The products described in this document shall not be used or embedded to any downstream products of which manufacture, use and/or sale are prohibited under any applicable laws and regulations.
- The information contained herein is presented only as a guide for the applications of our products. No responsibility is assumed by TOSHIBA for any infringements of patents or other rights of the third parties which may result from its use. No license is granted by implication or otherwise under any patents or other rights of TOSHIBA or the third parties.
- Please contact your sales representative for product-by-product details in this document regarding RoHS compatibility. Please use these products in this document in compliance with all applicable laws and regulations that regulate the inclusion or use of controlled substances. Toshiba assumes no liability for damage or losses occurring as a result of noncompliance with applicable laws and regulations.