

AIF25R48 Series Isolated DC/DC Converter Module

36-75V Input, 28V single Output

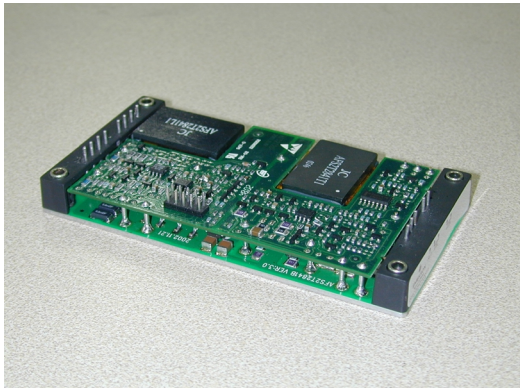

Industry Standard Size: 4.6" X 2.4" 0.5" package

Features

- **4.6" X 2.4" X 0.5"** full brick package
- **Basic insulation**
- **High efficiency**
- **High power density**
- **Current sharing function**
- **2:1 wide input range of 36-75V**
- **CNT (input side and output side) function**
- **Trim function**
- **\pm Sense function**
- **AUX/IOG/TMP signal output**
- **Over- temperature protection**
- **Input under-voltage protection**
- **Output short circuit protection**
- **Output over-voltage protection**
- **Wide operating case temperature range**

Options

Choice of positive logic or negative logic for CNT function

Choice of short pins or long pins

Description

The AIF25R48 series is a new Aluminum baseplate full brick DC-DC converter. The AIF25R48 series uses an industry standard package size: 116.8mm X 61mm X 12.7mm (4.6"x2.4"x0.5"), provides CNT, current sharing, trim, \pm sense, and IOG/TMP functions.

AIF25R48 series comes in 48V input versions, each of which uses a 2:1 input range of 36~75V. It can provide 28V@25A single output, which is isolated from input.



Contents

Options	1
Description	1
Electrical Specifications	4
Input Specifications	4
Absolute Maximum Ratings	5
Output Specifications	6
Output Specifications (Cont).....	7
Feature Specifications.....	8
Characteristic Curves	9
Performance Curves – Efficiency.....	9
Performance Curves – Output Performance Curves.....	9
Performance Curves – Transient Response.....	10
Performance Curves – Transient Response (Cont).....	10
Performance Curves – Startup Characteristics	11
Performance Curves – Startup from CNT1 Control	11
Feature Description	12
CNT Function	12
Trim	13
Minimum Load Requirement	14
Output Over-Current and Short Protection	14
Output Over-Voltage Protection.....	14
Over Temperature Protection	14
Current Sharing	15
Sense.....	16
AUX/IOG/TMP.....	18
Output Filter.....	18
Decoupling.....	19
Ground Loops	19
Design Consideration	21
Typical Application	21
Fusing	21
Input Reverse Voltage Protection	21



AIF25R48 Series Technical Reference Note

EMC	22
Safety Consideration.....	23
Thermal Management.....	24
Technologies	24
Basic Thermal Management	24
Module Derating with Heatsink	25
Module Derating without Heatsink	26
MTBF.....	26
Mechanical Considerations.....	27
Installation	27
Soldering.....	27
Mechanical Chart (pin side view).....	28
Ordering Information	29
Model Numbering	29



Electrical Specifications

Unless otherwise indicated, specifications apply over all operating input voltage and temperature conditions. Standard test condition on a single unit with a heatsink of 270mm × 220mm × 43mm is as following:

Tc(case):	25°C
+Vin:	48V ± 2%
-Vin:	Return pin for +Vin
CNT1:	Connect to -Vin
+Vout:	Connect to load
-Vout:	Connect to load (return)
+Sense:	Connect to +Vout
-Sense:	Connect to -Vout
VB, Trim(Vadj):	Open
CNT2, CNT3:	Open
CB:	Open
IOG, TMP:	Open
AUX:	Open

Input Specifications

Parameter	Device	Symbol	Min	Typ	Max	Unit
Operating Input Voltage	All	V_i	36	48	75	V _{DC}
Maximum Input Current ($V_i = 0$ to $V_{i,max}$, $I_o = I_{o,max}$)	All	$I_{i,max}$	-	-	23	A
Input Reflected-ripple Current ($V_i = V_{i,nom}$, 5Hz to 20MHz: 12uH source impedance: Tc = 25 °C.)	All	I_i	-	-	160	mAp-p
No Load Input Power ($V_i = V_{i,nom}$)	All	-	-	-	7	W

CAUTION: This power module is not internally fused. An input line fuse must always be used.



Absolute Maximum Ratings

Stresses in excess of the absolute maximum ratings can cause permanent damage to the device. These are absolute stress ratings only. Functional operation of the device is not implied at these or any other conditions in excess of those given in the operational sections of the IPS. Exposure to absolute maximum ratings for extended periods can adversely affect device reliability.

Parameter	Device	Symbol	Min	Typ	Max	Unit
Input Voltage:						
Continuous:	All	V_i	0	-	80	Vdc
Transient (100ms)	All	$V_{i, trans}$	0	-	100	Vdc
Highest voltage to CNT1	All	-	-	-	15	Vdc
Operating Ambient Temperature	All	T_a	-20		55	°C
Operating Case Temperature (with a heatsink)	All	T_c	-	-	100	°C
Storage Temperature	All	T_{STG}	-55	-	125	°C
Operating Humidity	All	-	-	-	85	%
I/O Isolation (Conditions : 50 μ A for 5 sec, slew rate of 1500V/10sec)						
Input-Output	All	-	-	-	1500	Vdc
Input-Case		-	-	-	1500	Vdc
Output-Case		-	-	-	500	Vdc
Output Power	All	$P_{o,max}$	-	-	700	W



Output Specifications

Parameter	Device	Symbol	Min	Typ	Max	Unit
Output Ripple and Noise (Across 1 μ F @50V, X7R ceramic capacitor & 1000 μ F @50V LOW ESR Aluminum capacitor) Peak-to-Peak (5 Hz to 20 MHz)	All	-	-	100	200	mVp-p
External Load Capacitance	All	-	470	1000	6800	μ F
Output Voltage Setpoint ($V_i = V_{in, nom}$; $I_o = 18A$; $T_c = 25^\circ C$)	All	$V_{o, set}$	27.5	28	28.5	Vdc
Output Regulation:						
Line (V_i, min to V_i, max)	All	-	-	0.01	0.2	%
Load ($I_o = I_{o, min}$ to $I_{o, max}$)	All	-	-	0.1	0.5	%
Temperature	All	-	-	-	0.02	% $V_o/^\circ C$
Rated Output Current	All	I_o	2.5	-	25	A
Output Current-limit Inception (when unit is shut down)	All	I_o	26.25	-	35	A (RMS)
Efficiency ($V_i = V_{i, nom}$; I_o, nom ; $T_c = 25^\circ C$)	All	η	86	89	-	%
Switching Frequency	All	-		340		KHz



Output Specifications (Cont)

Parameter	Device	Symbol	Min	Typ	Max	Unit
Dynamic Response : ($\Delta I_o/\Delta t = 1A/10\mu s$)						
Load Change from $I_o = 50\%$ to 75% of $I_{o,nom}$: Peak Deviation Settling Time (to $V_{o,nom}$)	All	-	-	-	3 500	$\%V_{o,nom}$ μsec
Load Change from $I_o = 50\%$ to 25% of $I_{o,nom}$: Peak Deviation Settling Time (to $V_{o,nom}$)	All	-	-	-	3 500	$\%V_{o,nom}$ μsec
Turn-On Time ($I_o = I_{o,nom}$; V_o within 1%)	All	-	-	-	200	msec
Output Voltage Overshoot ($I_o = I_{o,nom}$; $T_A = 25^\circ C$)	All	-	-	-	5	$\%V_{o,nom}$



Feature Specifications

Parameter	Device	Symbol	Min	Typ	Max	Unit
CNT1 pin voltage :						
Logic Low	All		-0.7	-	1	V
Logic High	All		3.5	-	7	V
Enable pin current :						
Logic Low	All		-	-	1	mA
Output Voltage Adjustment Range	All	-	80	-	110	%Vo,nom
Output Over-voltage	ALL	-	32.2	-	39.2	V
Over Temperature protect	All	T	101	-	120	°C
Under-Voltage Lockout						
Turn-on Point	All	-	31	34	36	V
Turn-off Point	All	-	30	33	35	V
Current Sharing Accuracy	All	-	-	3	10	%
+SENSE	All	-	-	-	1	%Vo,nom
-SENSE	All	-	-	-	1	%Vo,nom
AUX	All	-		13	16	V
IOG	All	-		5		V
TMP	All	-		5		V
Isolation Capacitance	All	-	-	1600	-	PF
Isolation Resistance	All	-	10	-	-	MΩ
Calculated MTBF (Io = Io,nom ; TA = 25°C)	All	-	-	1,500,000	-	Hours
Weight	All	-	-	150	-	g



Characteristic Curves

Performance Curve – Efficiency

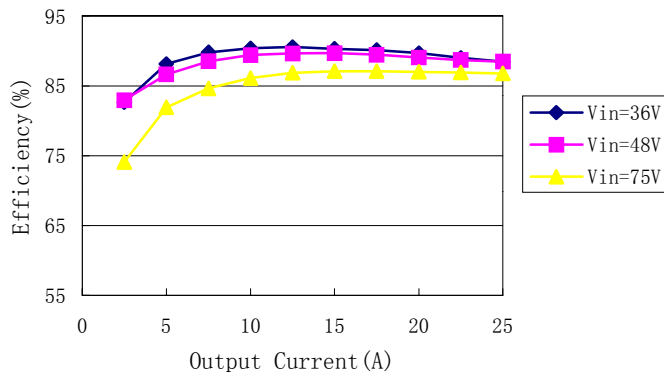

Typical Efficiency Curve

Performance Curves – Output Performance Curve

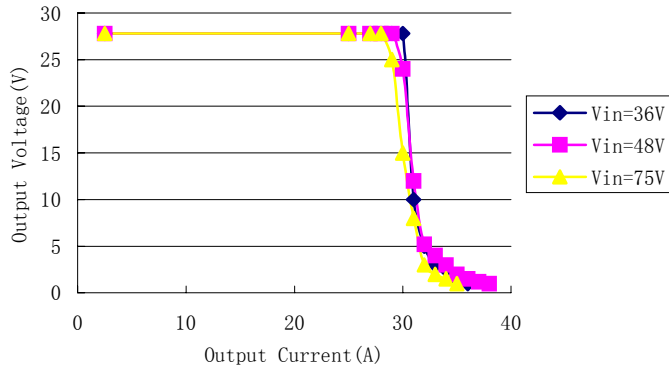

Output Performance Curve

Performance Curves – Transient Response

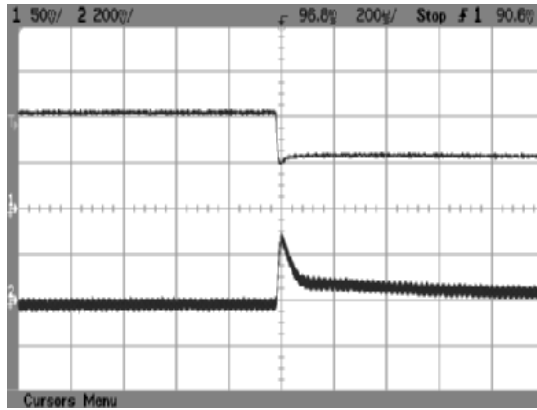

50%-25%loman load change

Performance Curves – Transient Response (Cont)

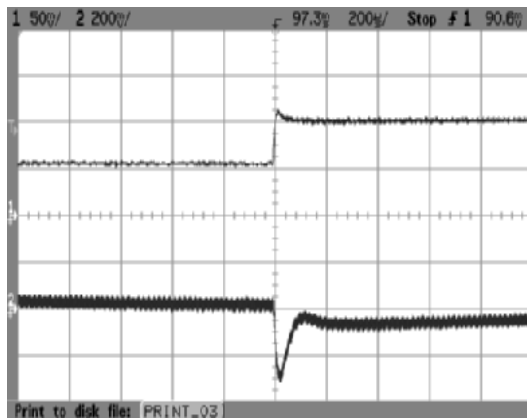

25%-50%loman load change



Performance Curves – Startup Characteristics

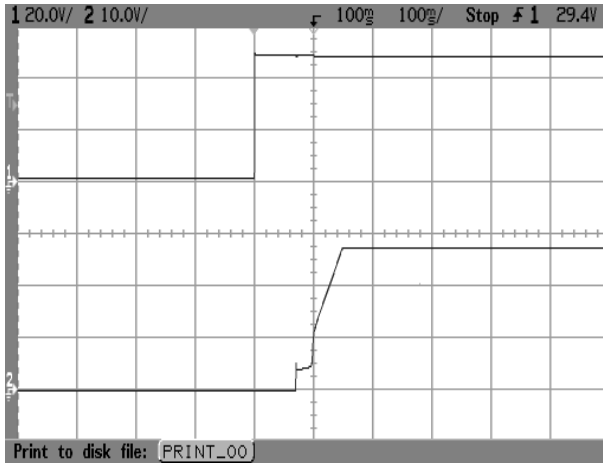

Start-up from Power On

Performance Curves – Startup from CNT1 Control

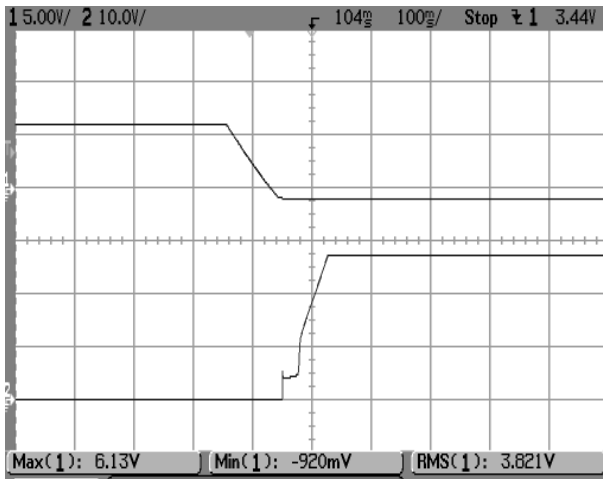

Start-up from CNT1 On

Feature Description

CNT Function

CNT function is available on both side of input (CNT1) and output (CNT2/CNT3).

Input side CNT(CNT1) Function

Two CNT1 logic options are available. The CNT1 logic, CNT1 voltage and the module working state are as the following Table 1. The ground pin of CNT1 is “-Vin” pin. And CNT2/CNT3 must be open when CNT1 is used.

	L	H	OPEN
N	ON	OFF	OFF
P	OFF	ON	ON

Table 1

N--- means “Negative Logic”, P--- means “Positive Logic”

L--- means “Low Logic Voltage”, $-0.7V \leq L \leq 1V$

H--- means “High Logic Voltage”, $3.5V \leq H \leq 7V$

ON--- means “Module is on”, OFF--- means “Module is off”

Open--- means “CNT1 pin is left open “

Note: Normally, $V_{CNT1} \leq 8V$, but when CNT1 is left open, V_{CNT} may reach to 15V.

The following Figure shows a few simple CNT1 circuits.

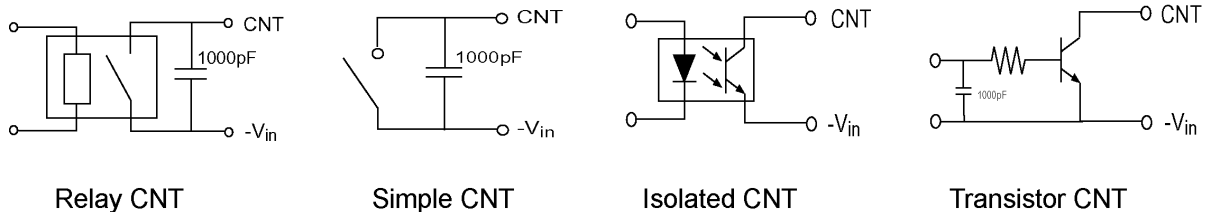

Fig.1 A few simple CNT1 Circuits

Output Side CNT (CNT2/CNT3) Function

Two CNT2/CNT3 logic options are available. CNT2/CNT3 can be used as shown in Fig2 with a “Negative Logic” module. The switch is opposite with a “Positive Logic” module. CNT1 must be connected to -Vin when CNT2/CNT3 is used. And make sure that sink current of output side CNT circuit should be less than 12mA.

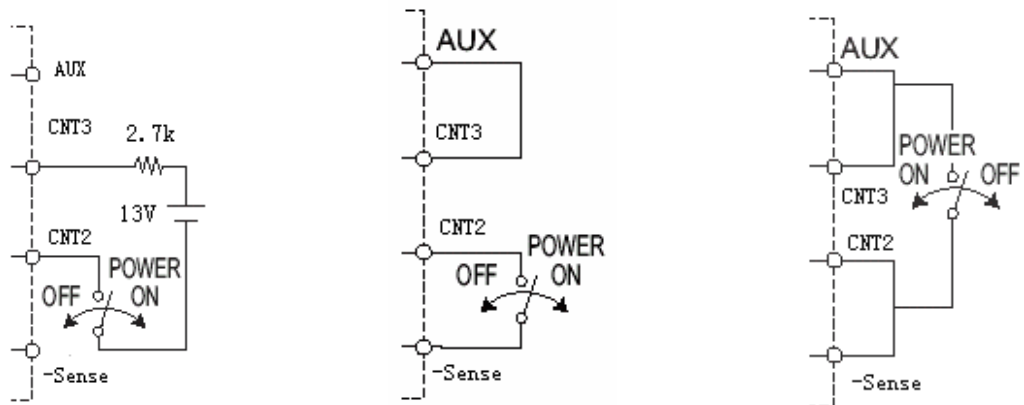

Fig.2 Output Side CNT (CNT2/CNT3) Function for “Negative Logic” Module

Trim

The output voltage of the AIF25R48 series can be trimmed using the trim pin provided. Applying a resistor to the trim pin through a voltage divider from the VB will cause the output to increase 10% or decrease 20%. Trimming up by more than 10% of the nominal output may activate the OVP circuit or damage the converter. Trimming down more than 20% can cause the converter to regulate improperly. If the trim pin is not needed, it should be left open.

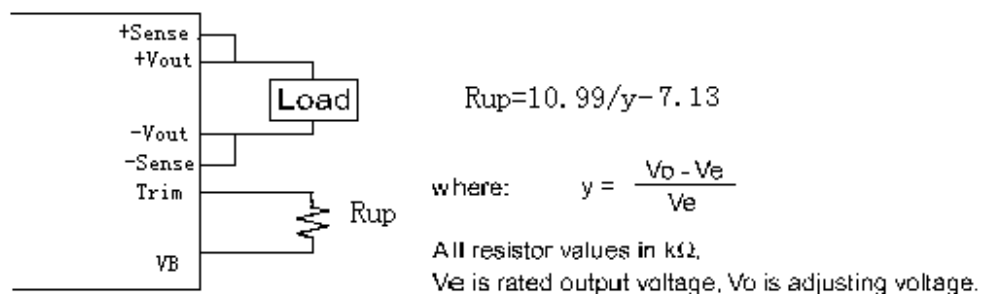

Fig.3 Trim Up Circuit and Formula

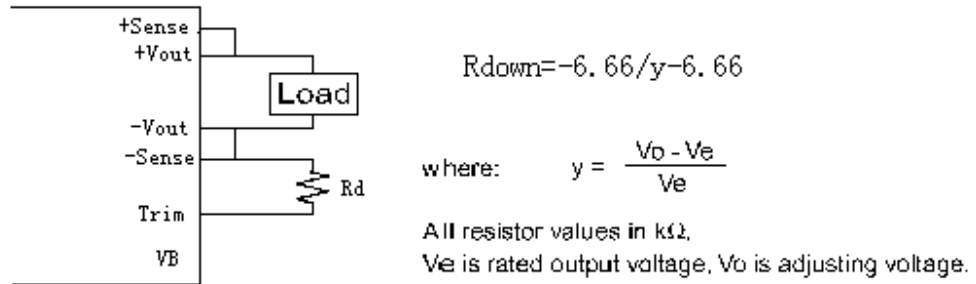

Fig.4 Trim Down Circuit and Formula

Minimum Load Requirement

The minimum load of AIF25R48 series is 2.5A.

Output Over-Current and Short Protection

AIF25R48 series DC/DC converters feature foldback current limiting as part of their Over-current Protection (OCP) circuits. When output current exceeds 110 to 140% of rated current, such as during a short circuit condition, the module will work on intermittent mode, also can tolerate short circuit conditions indefinitely. When the over-current condition is removed, the converter will automatically restart.

A sound may occur from module when the output is shorted.

Output Over-Voltage Protection

The over-voltage protection has a separate feedback loop, which activates when the output voltage exceeds 120% to 140% of the nominal output voltage. The module can restart by turning on the power or turning on the CNT (CNT1 or CNT2/CNT3) signal again.

Over Temperature Protection

AIF25R48 series DC/DC converters will shut down when the temperature of the baseplate reaches 101°C to 120°C, and the module will automatically restart if the temperature of the baseplate is under 100°C. The measurement point is indicated in below Fig 5. The module must be mounted on a heatsink of 270mm×220mm×43mm when measuring OTP point.

The OTP point is about 85°C without a heatsink.

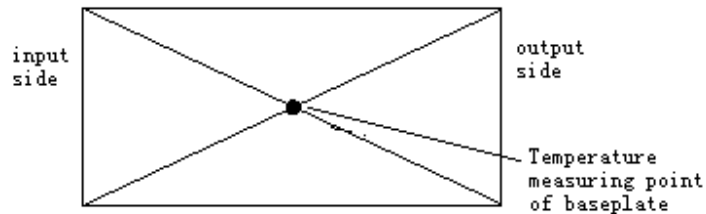

Fig.5 Measuring OTP Point of AIF25R48 series

Current Sharing

Parallel operation is available by connecting the modules as shown in Fig 6.

As variance of output current drew from each power supply is 10% maximum, the total output current must not exceed the value determined by the following equation.

(Output current in parallel operation)=(the rated current per module)*(number of module)*0.9

In parallel operation, the maximum operative number of modules is 7.

When output voltage adjustment is not used. TRM, VB open, R1, R2, VR1, Rva, Rvb, Rta, Rtb... are not needed.

Thick wire should be used for wiring between the power supply and load, and line drop should be less than 0.3V.

Connect the sensing line and the power line by one point after connecting each power supply's sense pins (+Sense, -Sense).

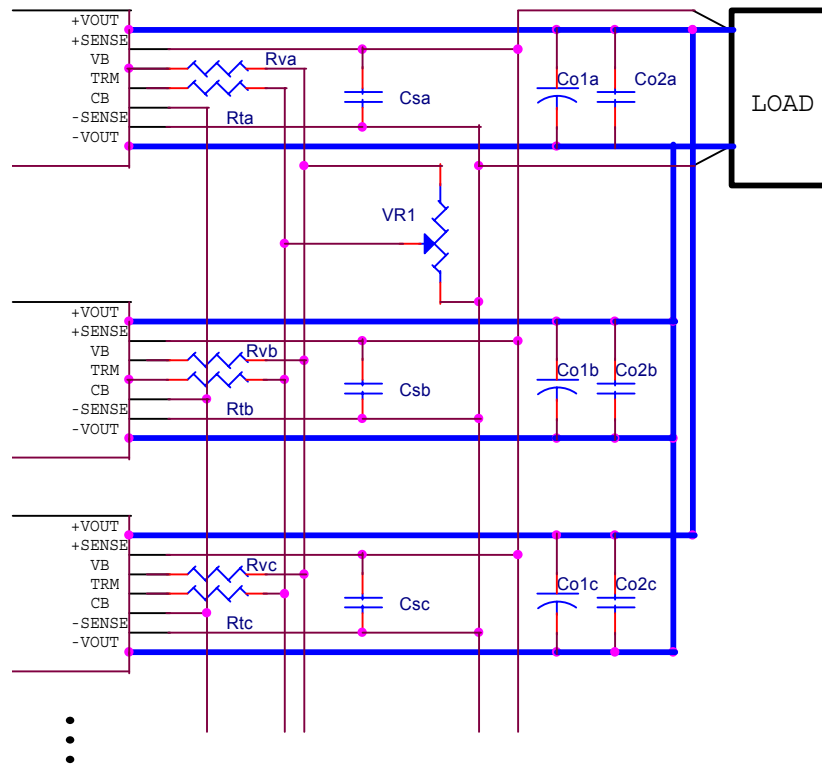

Fig.6 Parallel operation

Rva, Rvb,.....: 470 Ω

Rta, Rtb,....: 22K Ω

Vr1 10K Ω

Csa,Csb,....: 0.1 μ F

Sense

Sense terminal is provided to compensate for voltage drop across the load wire.

When sense function is not used, short +sense terminal to +Vout terminal and, -sense terminal to -Vout terminal.



AIF25R48 Series Technical Reference Note

When sense function is used, it should pay attention to that voltage compensation range for line drop must be less than 1%Vo. Using shield wire, twist pair, or parallel pattern to reduce noise effect.

AUX/IOG/TMP

AUX

AUX is built in to operate the output side CNT(CNT2/CNT3).

If AUX is not used for CNT2/CNT3, AUX can be used for IOG or TMP signal output by opto coupler.

Short protection resistance(2.7k Ω) is built in.

AUX voltage at open circuit is 13Vtpy, 16Vmax.

IOG

IOG signal turns “H” from “L” within 1 second when the output of the module is shut down.

The specification of IOG is shown in table 2.

TMP

TMP signal turns “L” from “H” within 1 second when over temperature is detected.

The specification of TMP is shown in Table 2.

item	TMP	IOG
Function	Normal operation “H”	Normal operation “L”
	Over temperature “L”	Malfunction “H”
Base pin	-Sense	
Level voltage “L”	0.5Vmax at 5mA	
Level voltage “H”	5V typ	
Maximum sink current	10mA max	
Maximum applicable voltage	35V max	

Table 2 The specification of IOG and TMP

Output Filter

When the load is sensitive to ripple and noise, an output filter can be added to minimize the effects. A simple output filter to reduce output ripple and noise can be made by connecting a capacitor C1 across the output as shown in Figure ‘Output Ripple Filter’. The recommended value for the output capacitor C1 is 1000 μ F.

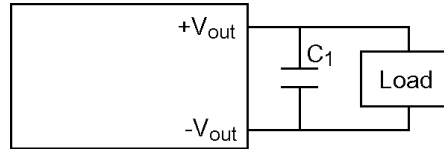

Fig.7 Output Ripple Filter

Extra care should be taken when long leads or traces are used to provide power to the load. Long lead lengths increase the chance for noise to appear on the lines. Under these conditions C2 can be added across the load, with a 0.47 μ F ceramic capacitor C2 in parallel generally as shown in Figure 'Output Ripple Filter for a Distant Load'.

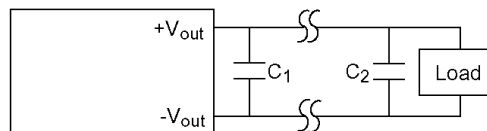

Fig.8 Output Ripple Filter for a Distant Load

Decoupling

Noise on the power distribution system is not always created by the converter. High speed analog or digital loads with dynamic power demands can cause noise to cross the power inductor back onto the input lines. Noise can be reduced by decoupling the load. In most cases, connecting a 10 μ F tantalum or ceramic capacitor in parallel with a 0.1 μ F ceramic capacitor across the load will decouple it. The capacitors should be connected as close to the load as possible.

Ground Loops

Ground loops occur when different circuits are given multiple paths to common or earth ground, as shown in Figure 'Ground Loops'. Multiple ground points can slightly different potential and cause current flow through the circuit from one point to another. This can result in additional noise in all the circuits. To eliminate the problem, circuits should be designed with a single ground connection as shown in Figure 'Single Point Ground'.

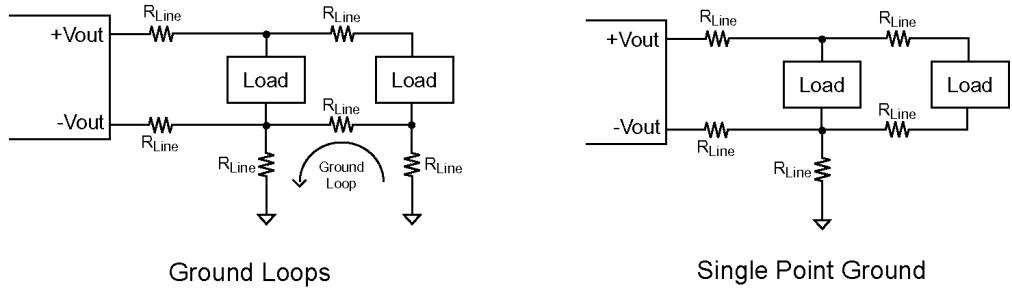

Fig.9 Ground Loops

Design Consideration

Typical Application

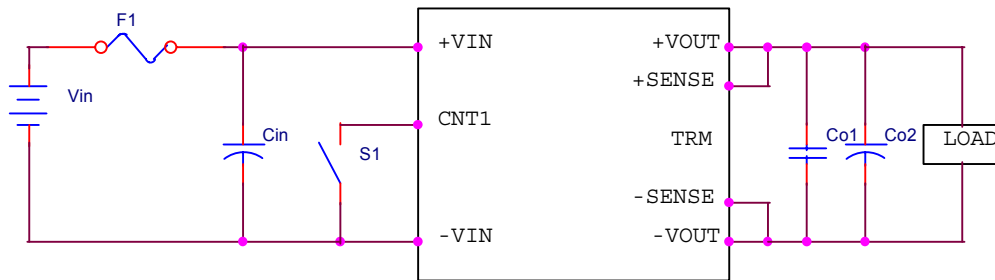

Fig.10 typical application

F1: 30A

Cin: Recommended 470 μ F/100V low ESR Aluminum capacitor.

Co1: Recommended 1 μ F/50V film capacitor.

Co2: Recommended 1000 μ F/50V low ESR Aluminum capacitor.

Fusing

The AIF25R48 series power modules have no internal fuse. An external fuse must always be employed! To meet international safety requirements, a 250 Volt rated fuse should be used. If one of the input lines is connected to chassis ground, then the fuse must be placed in the other input line.

Standard safety agency regulations require input fusing. Recommended fuse ratings for the AIF25R48 series are 30A.

Input Reverse Voltage Protection

Under installation and cabling conditions where reverse polarity across the input may occur, reverse polarity protection is recommended. Protection can easily be provided as shown in Figure 'Reverse Polarity Protection Circuit'. In both cases the diode used is rated for 40A/100V. Placing the diode across the inputs rather than in-line with the input offers an advantage in that the diode only conducts in a reverse polarity condition, which increases circuit efficiency and thermal performance.

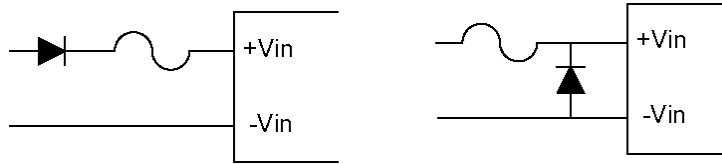

Fig 11 Reverse Polarity Protection Circuit

EMC

For conditions where EMI is a concern, a different input filter can be used. Fig 12 'EMI Reduction Filter' shows a filter designed to reduce EMI effects. AIF25R48 SERIES can meet EN55022 CLASS A with Fig 12.

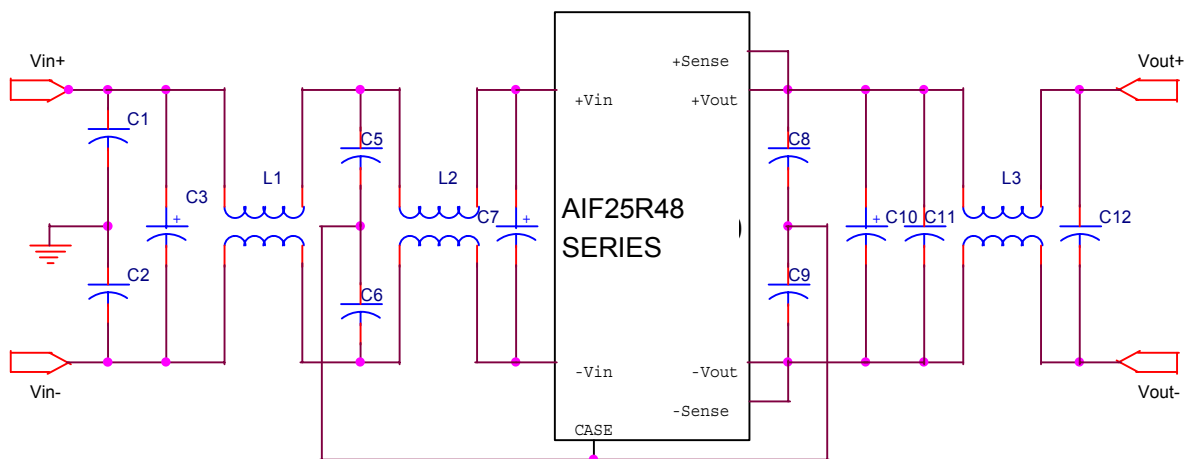

Fig.12 EMI Reduction Filter

L1, L2: 3.25mH

L3: 110 μ H

C3, C7: 470 μ F/100V low ESR Aluminum capacitor.

C10: 1000 μ F/50V low ESR Aluminum capacitor.

C1, C2: 2.2 μ F/250V

C5, C6: 0.15 μ F/250V

C8, C9: 4.7Nf/1000V

C11, C12: 1 μ F/50V



Safety Consideration

For safety-agency approval of the system in which the power module is used, the power module must be installed in compliance with the spacing and separation requirements of the end-use safety agency standard, i.e., UL1950, CSA C22.2 No. 950-95, and EN60950. The AIF25R48 SERIES input-to-output isolation is an basic insulation. The DC/DC power module should be installed in end-use equipment, in compliance with the requirements of the ultimate application, and is intended to be supplied by an isolated secondary circuit. When the supply to the DC/DC power module meets all the requirements for SELV (<60Vdc), the output is considered to remain within SELV limits (level 3). If connected to a 60Vdc power system, double or reinforced insulation must be provided in the power supply that isolates the input from any hazardous voltages, including the ac mains. One Vin pin and one Vout pin are to be grounded or both the input and output pins are to be kept floating. Single fault testing in the power supply must be performed in combination with the DC/DC power module to demonstrate that the output meets the requirement for SELV. The input pins of the module are not operator accessible.

Note: Do not ground either of the input pins of the module, without grounding one of the output pins. This may allow a non-SELV voltage to appear between the output pin and ground.

Thermal Management

Technologies

AIF25R48 series module has typical efficiency of 89% at full load. With less heat dissipation and temperature-resistant components such as ceramic capacitors, the module exhibit good behavior during pro-longed exposure to high temperatures. Maintaining the operating case temperature (T_c) within the specified range help keep internal component temperatures within their specifications, which in turn help keep MTBF from falling below the specified rating. Proper cooling of the power modules is also necessary for reliable and consistent operation.

Basic Thermal Management

Measuring the case temperature of the module (T_c) as the method shown in Figure 5 can verify the proper cooling. The module should work under 55°C ambient for the reliability of operation and T_c must not exceed 100°C while operating in the final system configuration. The measurement can be made with a surface probe after the module has reached thermal equilibrium. If a heat sink is mounted to the case, make the measurement as close as possible to the indicated position. It makes the assumption that the final system configuration exists and can be used for a test environment. Note that T_c of module must always be checked in the final system configuration to verify proper operational due to the variation in test conditions. Thermal management acts to transfer the heat dissipated by the module to the surrounding environment. The amount of power dissipated by the module as heat (P_d) is got by the equation below:

$$P_d = P_i - P_o$$

where : P_i is input power; P_o is output power; P_d is dissipated power.

Also, module efficiency (η) is defined as the following equation:

$$\eta = P_o / P_i$$

If eliminating the input power term, from two above equations can yield the equation below:

$$P_d = P_o (1 - \eta) / \eta$$

The module power dissipation then can be calculated through the equation.

Because each power module output voltage has a different power dissipation curve, a plot of power dissipation versus output current over three different line voltages is given in each module-specific data sheet. The typical power dissipation curve of AIF25R48 SERIES is shown as Fig.13.

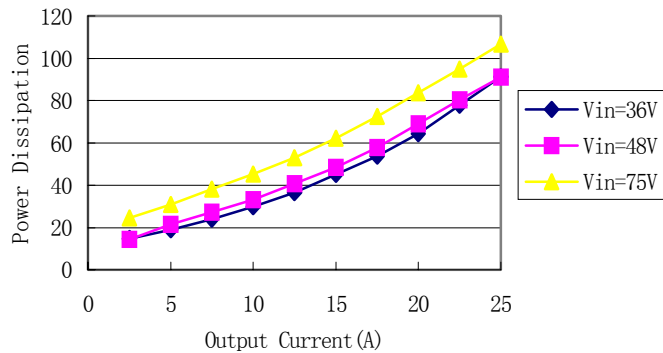

Fig.13 Typical Power Dissipation Curve of AIF25R48 series

Module Derating with Heatsink

Usually a customized heatsink is used for AIF25R48 SERIES because the power dissipation of AIF25R48 series is too large. A heatsink of full brick size can not consume so much heat.

A derating curve is shown in Fig14 with a heatsink of 270mm×220mm×43mm size. The module will have different derating curves with different heatsink designed by customer.

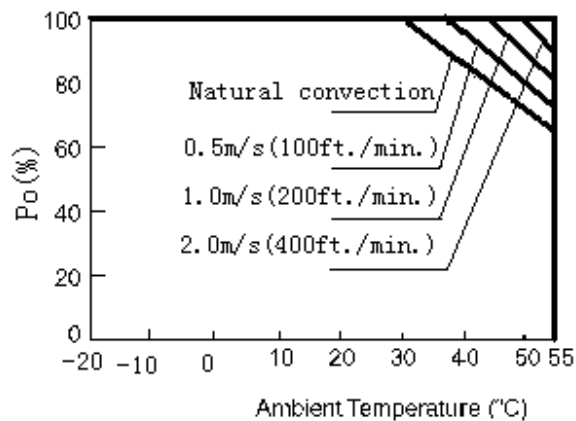

Fig.14 Temperature Derating Curve with Heatsink

Module Derating without Heatsink

The derating curves of AIF25R48 series without heatsink are shown in the following Fig15. We recommend that the customer use the AIF25R48 SERIES with proper heatsink for the better operation.

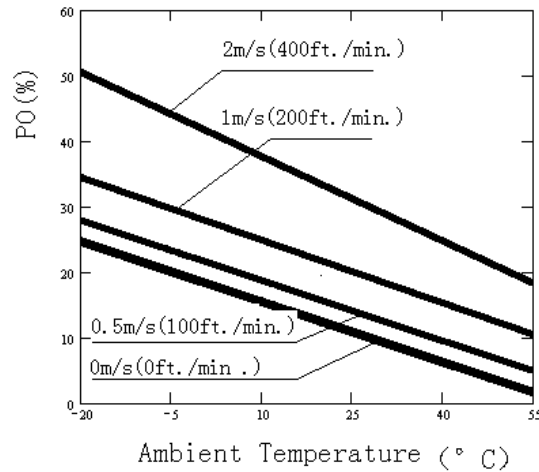

Fig.15 Temperature Derating Curve without Heatsink

MTBF

The MTBF, calculated in accordance with Bellcore TR-NWT-000332 is 1,500,000 hours. Obtaining this MTBF in practice is entirely possible. If the case temperature is expected to exceed +25°C, then we also advise an oriented for the best possible cooling in the air stream.

ASTEC can supply replacements for converters from other manufacturers, or offer custom solutions. Please contact the factory for details.



Mechanical Considerations

Installation

Although AIF25R48 series converters can be mounted in any orientation, free air-flowing must be taken. Normally power components are always put at the end of the airflow path or have the separate airflow paths. This can keep other system equipment cooler and increase component life spans.

Soldering

AIF25R48 series converters are compatible with standard wave soldering techniques. When wave soldering, the converter pins should be preheated for 20-30 seconds at 110°C, and wave soldered at 260°C for less than 10 seconds.

When hand soldering, the iron temperature should be maintained at 425°C and applied to the converter pins for less than 5 seconds. Longer exposure can cause internal damage to the converter. Cleaning can be performed with cleaning solvent IPA or with water.

Mechanical Chart (pin side view)

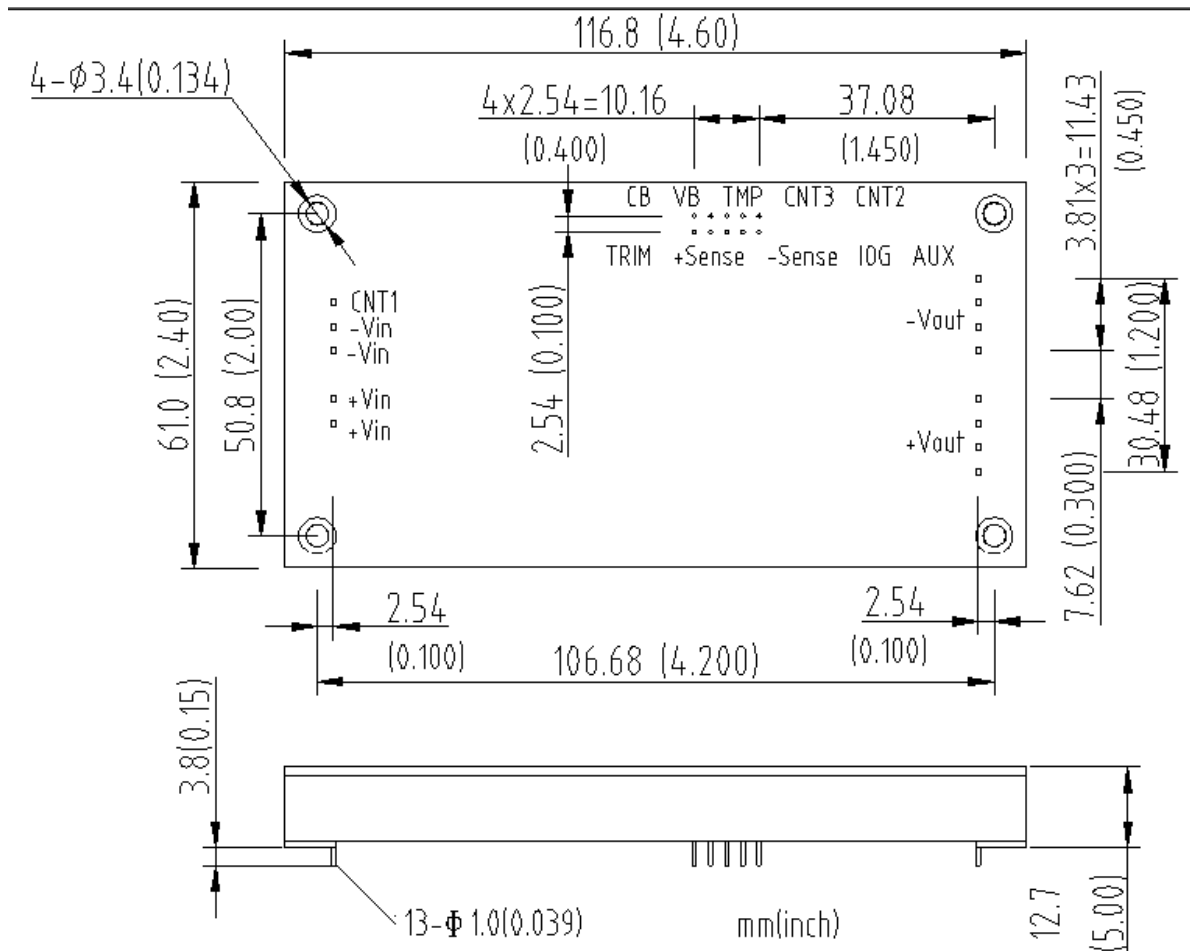

Tolerance:

Inchs	Millimeters
.XX ± 0.02	.X ± 0.5
.XXX ± 0.01	.XX ± 0.25

Pins

>4mm	± 0.02inch(± 0.5mm)
<4mm	± 0.01inch(± 0.25mm)

*: Pin length

Default: 4.8mm ± 0.5mm (0.189in. ± 0.02in.)

Product name with suffix "-6": 3.8mm ± 0.25mm (0.15in. ± 0.01in.)

Product name with suffix "-7": 5.8mm ± 0.5mm (0.228in. ± 0.02in.)

Product name with suffix "-8": 2.8mm ± 0.25mm (0.11in. ± 0.01in.)



Ordering Information

Model Number	Input Voltage (V)	Output Voltage (V)	Output Current (A)	Ripple (mV PP) typ.	Noise (mV pp) typ.	Efficiency % typ.
AIF25R48 SERIES	36-75	28	25	160	200	89

Model Numbering

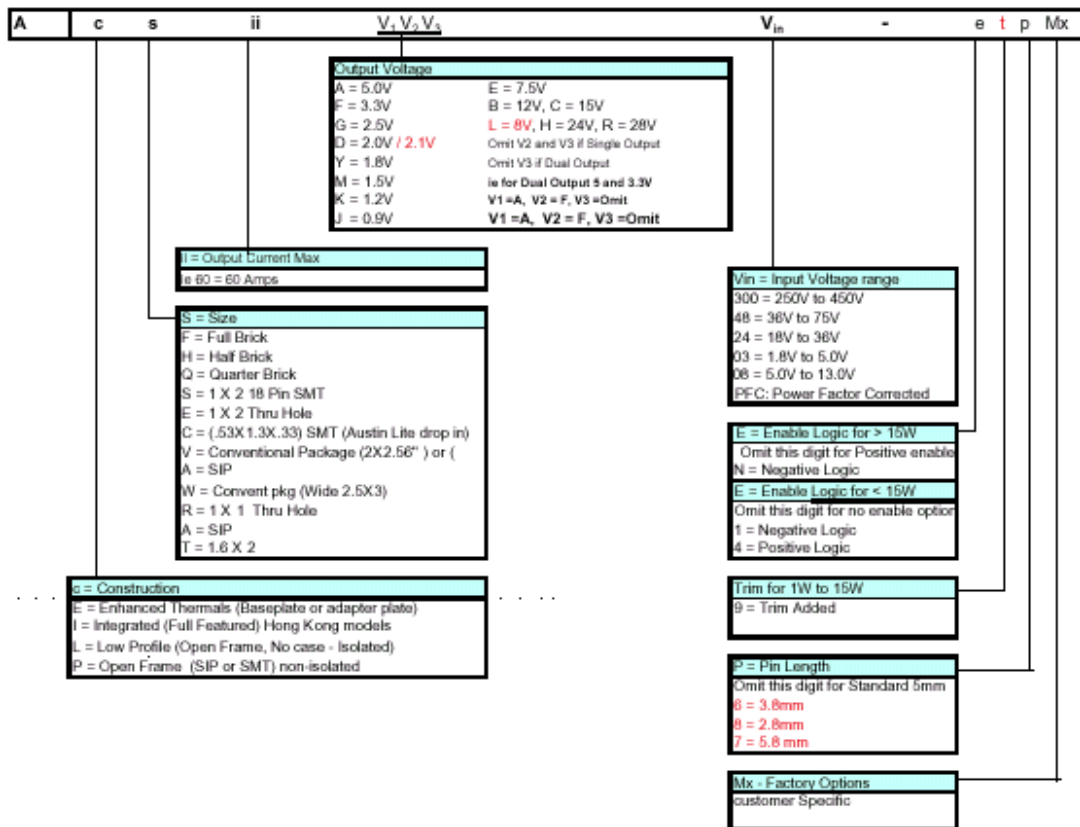

Note: For some products, they may not conform with the NEW PART NUMBER DESCRIPTION above absolutely.