

Type RCR-875D

Product Description

- 8.2mm Max. ϕ , 7.5mm Max. Height.
- Inductance range: 1.2 μ H ~ 10mH
- Rated Current Range: 74mA ~ 4.14A
- In addition to the standard versions of inductors shown here, custom inductors are available to meet your exact requirements



Feature

- Magnetically shielded construction.
- Ideally Used in Printers, LCD TV, DVD, Printer, Copy Machine, Mainboard of the compounding machines, etc as Power Supplies's Inductors or DC-DC Converter inductors.
- RoHS Compliance

Dimensions (mm)

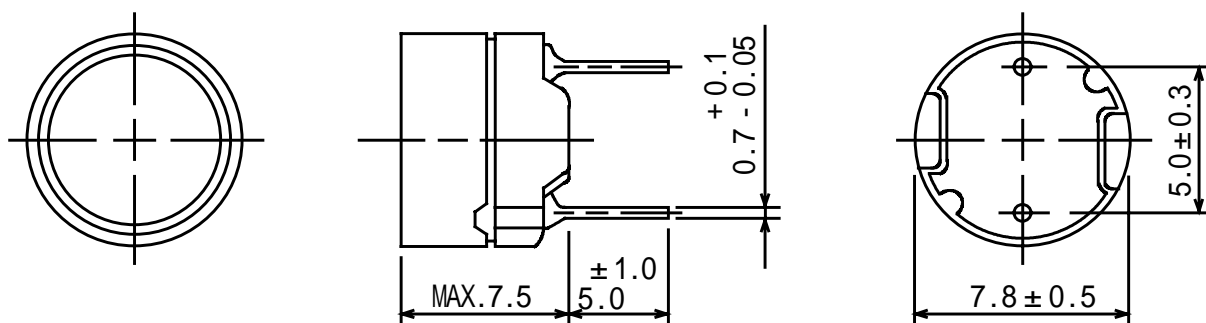

Type RCR-875D
Specification

Part Name	Stamp	Inductance [Within] 1	D.C.R. () [Max.] at 20	Rated Current (mA) 2	Unload Q (Ref.)
RCR875DNP-1R2L	1R2L	1.2 μ H \pm 15%	18 m	4140	20
RCR875DNP-1R7L	1R7L	1.7 μ H \pm 15%	22 m	3750	20
RCR875DNP-2R3L	2R3L	2.3 μ H \pm 15%	25 m	3450	18.5
RCR875DNP-3R0L	3R0L	3.0 μ H \pm 15%	28m	3250	19
RCR875DNP-3R9L	3R9L	3.9 μ H \pm 15%	31m	3080	18
RCR875DNP-4R7L	4R7L	4.7 μ H \pm 15%	35m	2940	19.5
RCR875DNP-5R6L	5R6L	5.6 μ H \pm 15%	39m	2820	18.5
RCR875DNP-7R0L	7R0L	7.0 μ H \pm 15%	43m	2680	18
RCR875DNP-8R2L	8R2L	8.2 μ H \pm 15%	47m	2550	16.5
RCR875DNP-10L	100L	10 μ H \pm 15%	50m	2400	53.5
RCR875DNP-12L	120L	12 μ H \pm 15%	54m	2250	54
RCR875DNP-15L	150L	15 μ H \pm 15%	62m	1950	52
RCR875DNP-18L	180L	18 μ H \pm 15%	71m	1780	52.5
RCR875DNP-22L	220L	22 μ H \pm 15%	0.08	1600	88
RCR875DNP-27L	270L	27 μ H \pm 15%	0.10	1400	90
RCR875DNP-33L	330L	33 μ H \pm 15%	0.14	1300	87
RCR875DNP-39L	390L	39 μ H \pm 15%	0.15	1200	84
RCR875DNP-47L	470L	47 μ H \pm 15%	0.17	1100	74
RCR875DNP-56K	560K	56 μ H \pm 10%	0.19	990	60
RCR875DNP-68K	680K	68 μ H \pm 10%	0.21	890	61
RCR875DNP-82K	820K	82 μ H \pm 10%	0.27	810	61
RCR875DNP-101K	101K	100 μ H \pm 10%	0.32	740	86
RCR875DNP-121K	121K	120 μ H \pm 10%	0.36	670	89
RCR875DNP-151K	151K	150 μ H \pm 10%	0.51	600	100
RCR875DNP-181K	181K	180 μ H \pm 10%	0.57	550	101
RCR875DNP-221K	221K	220 μ H \pm 10%	0.76	500	112
RCR875DNP-271K	271K	270 μ H \pm 10%	0.86	450	116
RCR875DNP-331K	331K	330 μ H \pm 10%	0.97	410	117
RCR875DNP-391K	391K	390 μ H \pm 10%	1.28	370	121
RCR875DNP-471K	471K	470 μ H \pm 10%	1.44	340	126
RCR875DNP-561K	561K	560 μ H \pm 10%	1.61	310	132
RCR875DNP-681K	681K	680 μ H \pm 10%	2.07	280	138
RCR875DNP-821K	821K	820 μ H \pm 10%	2.33	260	139
RCR875DNP-102K	102K	1.0 mH \pm 10%	2.72	230	145
RCR875DNP-122K	122K	1.2 mH \pm 10%	3.98	210	140
RCR875DNP-152K	152K	1.5 mH \pm 10%	4.50	190	144
RCR875DNP-182K	182K	1.8 mH \pm 10%	6.81	170	147
RCR875DNP-222K	222K	2.2 mH \pm 10%	7.56	160	152
RCR875DNP-272K	272K	2.7 mH \pm 10%	8.54	140	156
RCR875DNP-332K	332K	3.3 mH \pm 10%	9.74	130	158
RCR875DNP-392K	392K	3.9 mH \pm 10%	12.9	120	159
RCR875DNP-472K	472K	4.7 mH \pm 10%	14.7	110	161
RCR875DNP-562K	562K	5.6 mH \pm 10%	20.4	99	151
RCR875DNP-682K	682K	6.8 mH \pm 10%	23.0	89	155
RCR875DNP-822K	822K	8.2 mH \pm 10%	30.6	81	146
RCR875DNP-103K	103K	10 mH \pm 10%	35.0	74	151

1 : Measuring frequency: L 100 μ H ~ 10 mH(1kHz); 1.2 μ H ~ 82 μ H(2.52 MHz)
 Q 10 μ H ~ 82 μ H(2.52 MHz); 100 μ H ~ 10 mH(100 kHz)
 1.2 μ H ~ 8.2 μ H(7.96 MHz)

2:Rated current: The DC current at which the inductance decreases 90% of it's initial value or when
 $t=40$,whichever is lower($T_a = 20$).