

### FEATURES

- 2.4 pF off capacitance
- <1 pC charge injection
- Low leakage; 0.6 nA maximum @ 85°C
- 120  $\Omega$  on resistance
- Fully specified at  $\pm 15\text{ V}$ , +12 V
- No  $V_L$  supply required
- 3 V logic-compatible inputs
- Rail-to-rail operation
- 6-lead SOT-23 package

### APPLICATIONS

- Automatic test equipment
- Data acquisition systems
- Battery-powered systems
- Sample-and-hold systems
- Audio signal routing
- Video signal routing
- Communication systems

### GENERAL DESCRIPTION

The ADG1201/ADG1202 are monolithic complementary metal-oxide semiconductor (CMOS) devices containing an SPST switch designed in an *i*CMOS® (industrial CMOS) process. *i*CMOS is a modular manufacturing process combining high voltage CMOS and bipolar technologies. It enables the development of a wide range of high performance analog ICs capable of 33 V operation in a footprint that no previous generation of high voltage parts has been able to achieve. Unlike analog ICs using conventional CMOS processes, *i*CMOS components can tolerate high supply voltages while providing increased performance, dramatically lower power consumption, and reduced package size.

The ultralow capacitance and charge injection of these switches make them ideal solutions for data acquisition and sample-and-hold applications, where low glitch and fast settling are required. Fast switching speed coupled with high signal bandwidth make the parts suitable for video signal switching.

### FUNCTIONAL BLOCK DIAGRAM

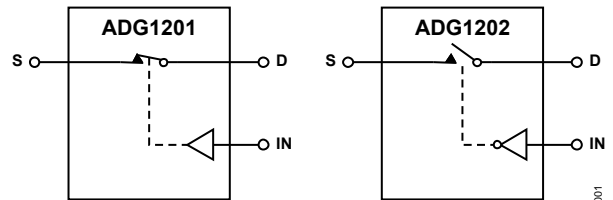

SWITCHES SHOWN FOR A LOGIC "1" INPUT

Figure 1.

06576-001

*i*CMOS construction ensures ultralow power dissipation, making the parts ideally suited for portable and battery-powered instruments.

The ADG1201/ADG1202 contain a single-pole/single-throw (SPST) switch. Figure 1 shows that with a logic input of 1, the switch of the ADG1201 is closed and that of the ADG1202 is open. Each switch conducts equally well in both directions when on and has an input signal range that extends to the supplies. In the off condition, signal levels up to the supplies are blocked.

### PRODUCT HIGHLIGHTS

1. Ultralow capacitance.
2. <1 pC charge injection.
3. Ultralow leakage.
4. 3 V logic-compatible digital inputs:  $V_{IH} = 2.0\text{ V}$ ,  $V_{IL} = 0.8\text{ V}$ .
5. No  $V_L$  logic power supply required.
6. SOT-23 package.

#### Rev. 0

Information furnished by Analog Devices is believed to be accurate and reliable. However, no responsibility is assumed by Analog Devices for its use, nor for any infringements of patents or other rights of third parties that may result from its use. Specifications subject to change without notice. No license is granted by implication or otherwise under any patent or patent rights of Analog Devices. Trademarks and registered trademarks are the property of their respective owners.

## TABLE OF CONTENTS

Features .....	1	Absolute Maximum Ratings .....	5
Applications.....	1	ESD Caution.....	5
Functional Block Diagram .....	1	Pin Configuration and Function Descriptions.....	6
General Description .....	1	Typical Performance Characteristics .....	7
Product Highlights .....	1	Test Circuits.....	10
Revision History .....	2	Terminology .....	12
Specifications.....	3	Outline Dimensions .....	13
Dual Supply .....	3	Ordering Guide .....	13
Single Supply .....	4		

## REVISION HISTORY

2/08—Revision 0: Initial Version

# SPECIFICATIONS

## DUAL SUPPLY

$V_{DD} = 15\text{ V} \pm 10\%$ ,  $V_{SS} = -15\text{ V} \pm 10\%$ ,  $GND = 0\text{ V}$ , unless otherwise noted.

Table 1.

Parameter	B Version <sup>1</sup>			Unit	Test Conditions/Comments	
	25°C	-40°C to +85°C	-40°C to +125°C			
<b>ANALOG SWITCH</b>						
Analog Signal Range			$V_{DD}$ to $V_{SS}$	V		
On Resistance ( $R_{ON}$ )	120	240	270	$\Omega$ typ $\Omega$ max	$V_{DD} = +13.5\text{ V}$ , $V_{SS} = -13.5\text{ V}$ $V_S = \pm 10\text{ V}$ , $I_S = -1\text{ mA}$ ; see Figure 20	
On Resistance Flatness ( $R_{FLAT(ON)}$ )	20	72	79	$\Omega$ typ $\Omega$ max	$V_S = -5\text{ V}$ , $0\text{ V}$ , and $+5\text{ V}$ ; $I_S = -1\text{ mA}$	
<b>LEAKAGE CURRENTS</b>						
Source Off Leakage, $I_S$ (Off)	$\pm 0.004$	$\pm 0.1$	$\pm 0.6$	nA typ nA max	$V_{DD} = +16.5\text{ V}$ , $V_{SS} = -16.5\text{ V}$ $V_S = \pm 10\text{ V}$ , $V_D = \pm 10\text{ V}$ ; see Figure 21	
Drain Off Leakage, $I_D$ (Off)	$\pm 0.004$	$\pm 0.1$	$\pm 0.6$	nA typ nA max	$V_S = \pm 10\text{ V}$ , $V_D = \pm 10\text{ V}$ ; see Figure 21	
Channel On Leakage, $I_D$ , $I_S$ (On)	$\pm 0.04$	$\pm 0.15$	$\pm 0.6$	nA typ nA max	$V_S = V_D = \pm 10\text{ V}$ ; see Figure 22	
<b>DIGITAL INPUTS</b>						
Input High Voltage, $V_{INH}$			2.0	V min		
Input Low Voltage, $V_{INL}$			0.8	V max		
Input Current, $I_{INL}$ or $I_{INH}$	0.005		$\pm 0.1$	$\mu\text{A}$ typ $\mu\text{A}$ max	$V_{IN} = V_{INL}$ or $V_{INH}$	
Digital Input Capacitance, $C_{IN}$	2.5			pF typ		
<b>DYNAMIC CHARACTERISTICS<sup>2</sup></b>						
$t_{ON}$	140	170	200	230	ns typ ns max	$R_L = 300\ \Omega$ , $C_L = 35\text{ pF}$ $V_S = 10\text{ V}$ ; see Figure 26
$t_{OFF}$	90	105	130	141	ns typ ns max	$R_L = 300\ \Omega$ , $C_L = 35\text{ pF}$ $V_S = 10\text{ V}$ ; see Figure 26
Charge Injection	-0.8				pC typ	$V_S = 0\text{ V}$ , $R_S = 0\ \Omega$ , $C_L = 1\text{ nF}$ ; see Figure 27
Off Isolation	80				dB typ	$R_L = 50\ \Omega$ , $C_L = 5\text{ pF}$ , $f = 1\text{ MHz}$ ; see Figure 23
Total Harmonic Distortion + Noise	0.15				% typ	$R_L = 10\text{ k}\Omega$ , $5\text{ V rms}$ , $f = 20\text{ Hz}$ to $20\text{ kHz}$
-3 dB Bandwidth	660				MHz typ	$R_L = 50\ \Omega$ , $C_L = 5\text{ pF}$ ; see Figure 24
$C_S$ (Off)	2.4				pF typ	$V_S = 0\text{ V}$ , $f = 1\text{ MHz}$
	3				pF max	$V_S = 0\text{ V}$ , $f = 1\text{ MHz}$
$C_D$ (Off)	2.8				pF typ	$V_S = 0\text{ V}$ , $f = 1\text{ MHz}$
	3.3				pF max	$V_S = 0\text{ V}$ , $f = 1\text{ MHz}$
$C_D$ , $C_S$ (On)	4.7				pF typ	$V_S = 0\text{ V}$ , $f = 1\text{ MHz}$
	5.6				pF max	$V_S = 0\text{ V}$ , $f = 1\text{ MHz}$
<b>POWER REQUIREMENTS</b>						
$I_{DD}$	0.001		1.0	$\mu\text{A}$ typ $\mu\text{A}$ max	$V_{DD} = +16.5\text{ V}$ , $V_{SS} = -16.5\text{ V}$ Digital inputs = $0\text{ V}$ or $V_{DD}$	
$I_{DD}$	60		95	$\mu\text{A}$ typ $\mu\text{A}$ max	Digital inputs = $5\text{ V}$	
$I_{SS}$	0.001		1.0	$\mu\text{A}$ typ $\mu\text{A}$ max	Digital inputs = $0\text{ V}$ , $5\text{ V}$ or $V_{DD}$	
$V_{DD}/V_{SS}$			$\pm 5$ to $\pm 16.5$	V min/max	$GND = 0\text{ V}$	

<sup>1</sup> Temperature range for B version is  $-40^\circ\text{C}$  to  $+125^\circ\text{C}$ .

<sup>2</sup> Guaranteed by design, not subject to production test.

# ADG1201/ADG1202

## SINGLE SUPPLY

$V_{DD} = 12\text{ V} \pm 10\%$ ,  $V_{SS} = 0\text{ V}$ ,  $GND = 0\text{ V}$ , unless otherwise noted.

Table 2.

Parameter	B Version <sup>1</sup>			Unit	Test Conditions/Comments
	25°C	-40°C to +85°C	-40°C to +125°C		
<b>ANALOG SWITCH</b>					
Analog Signal Range			0 V to $V_{DD}$	V	
On Resistance ( $R_{ON}$ )	300			$\Omega$ typ	$V_{DD} = 10.8\text{ V}$ , $V_{SS} = 0\text{ V}$
	475	567	625	$\Omega$ max	$V_S = 0\text{ V to }10\text{ V}$ , $I_S = -1\text{ mA}$ ; see Figure 20
On Resistance Flatness ( $R_{FLAT(ON)}$ )	60			$\Omega$ typ	$V_S = 3\text{ V, }6\text{ V, and }9\text{ V}$ , $I_S = -1\text{ mA}$
<b>LEAKAGE CURRENTS</b>					
Source Off Leakage, $I_S$ (Off)	$\pm 0.006$			nA typ	$V_{DD} = 13.2\text{ V}$ , $V_{SS} = 0\text{ V}$
	$\pm 0.1$	$\pm 0.6$	$\pm 1$	nA max	$V_S = 1\text{ V or }10\text{ V}$ , $V_D = 10\text{ V or }1\text{ V}$ ; see Figure 21
Drain Off Leakage, $I_D$ (Off)	$\pm 0.006$			nA typ	$V_S = 1\text{ V or }10\text{ V}$ , $V_D = 10\text{ V or }1\text{ V}$ ; see Figure 21
	$\pm 0.1$	$\pm 0.6$	$\pm 1$	nA max	
Channel On Leakage, $I_D$ , $I_S$ (On)	$\pm 0.04$			nA typ	$V_S = V_D = 1\text{ V or }10\text{ V}$ ; see Figure 22
	$\pm 0.15$	$\pm 0.6$	$\pm 1$	nA max	
<b>DIGITAL INPUTS</b>					
Input High Voltage, $V_{INH}$			2.0	V min	
Input Low Voltage, $V_{INL}$			0.8	V max	
Input Current, $I_{INL}$ or $I_{INH}$	0.001			$\mu\text{A}$ typ	$V_{IN} = V_{INL}$ or $V_{INH}$
			$\pm 0.1$	$\mu\text{A}$ max	
Digital Input Capacitance, $C_{IN}$	3			pF typ	
<b>DYNAMIC CHARACTERISTICS<sup>2</sup></b>					
$t_{ON}$	190			ns typ	$R_L = 300\ \Omega$ , $C_L = 35\text{ pF}$
	250	295	340	ns max	$V_S = 8\text{ V}$ ; see Figure 26
$t_{OFF}$	120			ns typ	$R_L = 300\ \Omega$ , $C_L = 35\text{ pF}$
	155	190	210	ns max	$V_S = 8\text{ V}$ ; see Figure 26
Charge Injection	0.8			pC typ	$V_S = 6\text{ V}$ , $R_S = 0\ \Omega$ , $C_L = 1\text{ nF}$ ; see Figure 27
Off Isolation	80			dB typ	$R_L = 50\ \Omega$ , $C_L = 5\text{ pF}$ , $f = 1\text{ MHz}$ ; see Figure 23
-3 dB Bandwidth	520			MHz typ	$R_L = 50\ \Omega$ , $C_L = 5\text{ pF}$ ; see Figure 24
$C_S$ (Off)	2.7			pF typ	$V_S = 6\text{ V}$ , $f = 1\text{ MHz}$
	3.3			pF max	$V_S = 6\text{ V}$ , $f = 1\text{ MHz}$
$C_D$ (Off)	3.1			pF typ	$V_S = 6\text{ V}$ , $f = 1\text{ MHz}$
	3.6			pF max	$V_S = 6\text{ V}$ , $f = 1\text{ MHz}$
$C_D$ , $C_S$ (On)	5.3			pF typ	$V_S = 6\text{ V}$ , $f = 1\text{ MHz}$
	6.3			pF max	$V_S = 6\text{ V}$ , $f = 1\text{ MHz}$
<b>POWER REQUIREMENTS</b>					
$I_{DD}$	0.001			$\mu\text{A}$ typ	$V_{DD} = 13.2\text{ V}$
			1.0	$\mu\text{A}$ max	Digital inputs = 0 V or $V_{DD}$
$I_{DD}$	60			$\mu\text{A}$ typ	Digital inputs = 5 V
			95	$\mu\text{A}$ max	
$V_{DD}$			+5/+16.5	V min/max	$V_{SS} = 0\text{ V}$ , $GND = 0\text{ V}$

<sup>1</sup> Temperature range for B version is -40°C to +125°C.

<sup>2</sup> Guaranteed by design, not subject to production test.

## ABSOLUTE MAXIMUM RATINGS

$T_A = 25^\circ\text{C}$ , unless otherwise noted.

**Table 3.**

Parameter	Rating
$V_{DD}$ to $V_{SS}$	35 V
$V_{DD}$ to GND	-0.3 V to +25 V
$V_{SS}$ to GND	+0.3 V to -25 V
Analog Inputs <sup>1</sup>	$V_{SS} - 0.3\text{ V}$ to $V_{DD} + 0.3\text{ V}$ or 30 mA, whichever occurs first
Digital Inputs <sup>1</sup>	GND - 0.3 V to $V_{DD} + 0.3\text{ V}$ or 30 mA, whichever occurs first
Peak Current, S or D	100 mA (pulsed at 1 ms, 10% duty cycle maximum)
Continuous Current per Channel, S or D	30 mA
Operating Temperature Range Industrial (B Version)	-40°C to +125°C
Storage Temperature Range	-65°C to +150°C
Junction Temperature	150°C
6 Lead SOT-23	
$\theta_{JA}$ , Thermal Impedance	229.6°C/W
$\theta_{JC}$ , Thermal Impedance	91.99°C/W
Reflow Soldering Peak Temperature, Pb-free	260°C

<sup>1</sup> Overvoltages at IN, S, or D are clamped by internal diodes. Current should be limited to the maximum ratings given.

Stresses above those listed under Absolute Maximum Ratings may cause permanent damage to the device. This is a stress rating only; functional operation of the device at these or any other conditions above those indicated in the operational section of this specification is not implied. Exposure to absolute maximum rating conditions for extended periods may affect device reliability.

### ESD CAUTION



**ESD (electrostatic discharge) sensitive device.** Charged devices and circuit boards can discharge without detection. Although this product features patented or proprietary protection circuitry, damage may occur on devices subjected to high energy ESD. Therefore, proper ESD precautions should be taken to avoid performance degradation or loss of functionality.

# ADG1201/ADG1202

## PIN CONFIGURATION AND FUNCTION DESCRIPTIONS

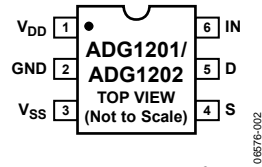

Figure 2. SOT-23 Pin Configuration

Table 4. Pin Function Descriptions

Pin No.	Mnemonic	Description
1	V <sub>DD</sub>	Most Positive Power Supply Potential.
2	GND	Ground (0 V) Reference.
3	V <sub>SS</sub>	Most Negative Power Supply Potential.
4	S	Source Terminal. Can be an input or output.
5	D	Drain Terminal. Can be an input or output.
6	IN	Logic Control Input.

Table 5. ADG1201/ADG1202 Truth Table

ADG1201 IN	ADG1202 IN	Switch Condition
1	0	On
0	1	Off

# TYPICAL PERFORMANCE CHARACTERISTICS

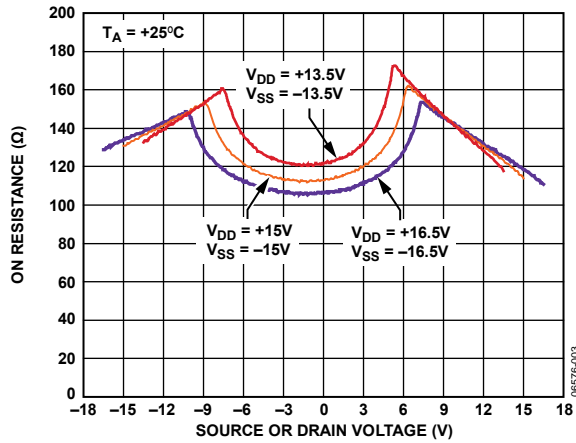

Figure 3. On Resistance as a Function of  $V_D$  ( $V_S$ ) for Dual Supply

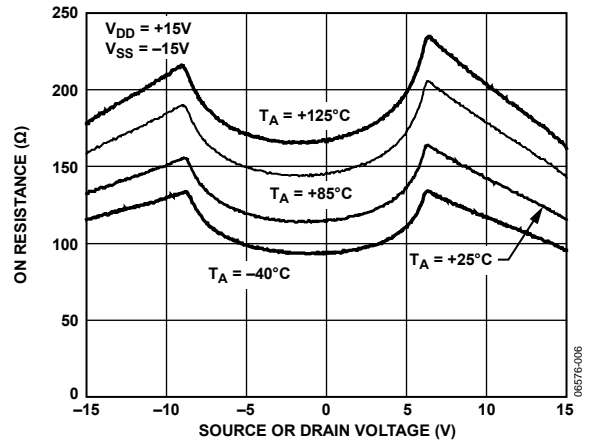

Figure 6. On Resistance as a Function of  $V_D$  ( $V_S$ ) for Different Temperatures, Dual Supply

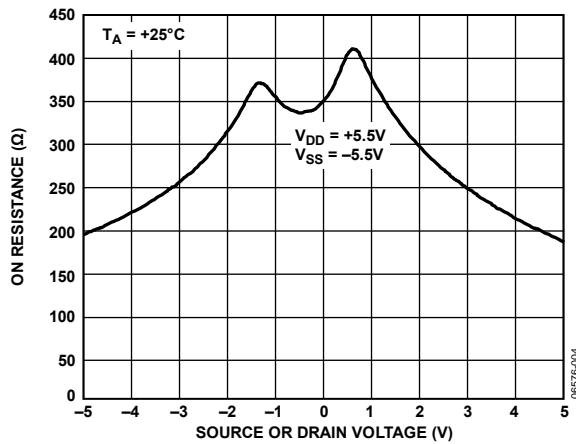

Figure 4. On Resistance as a Function of  $V_D$  ( $V_S$ ) for Dual Supply

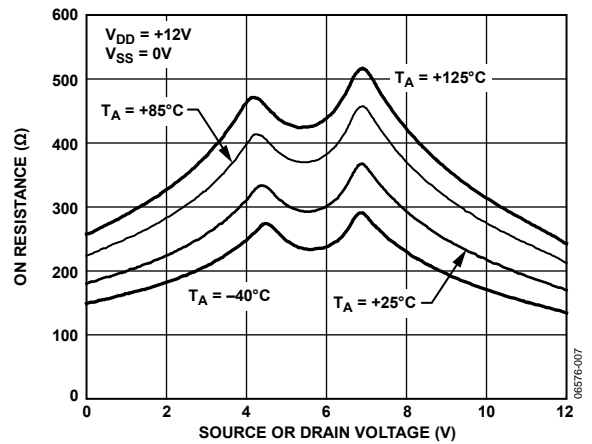

Figure 7. On Resistance as a Function of  $V_D$  ( $V_S$ ) for Different Temperatures, Single Supply

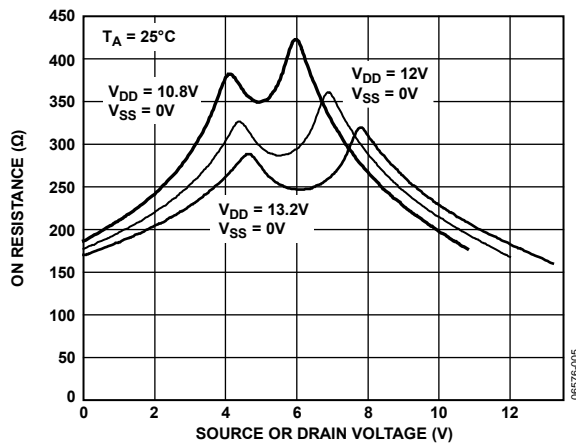

Figure 5. On Resistance as a Function of  $V_D$  ( $V_S$ ) for Single Supply

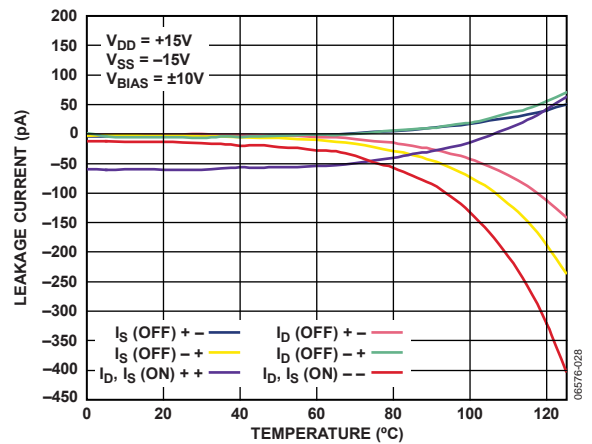

Figure 8. Leakage Currents as a Function of Temperature, Dual Supply

# ADG1201/ADG1202

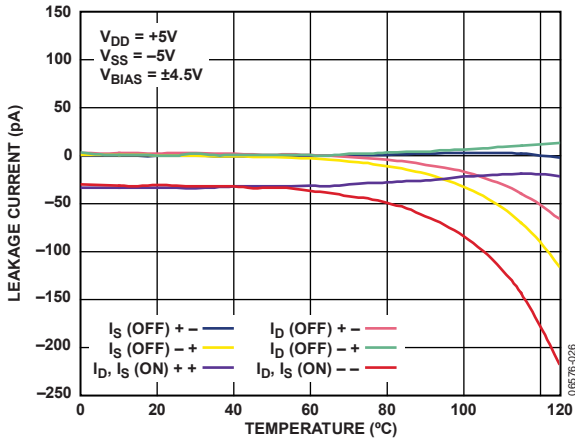

Figure 9. Leakage Currents as a Function of Temperature, Dual Supply

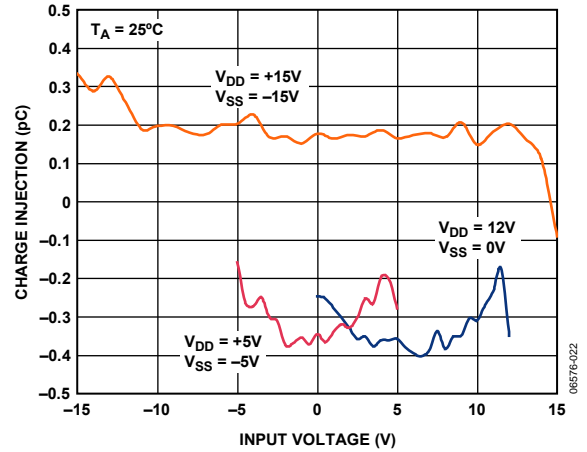

Figure 12. Charge Injection vs. Source Voltage

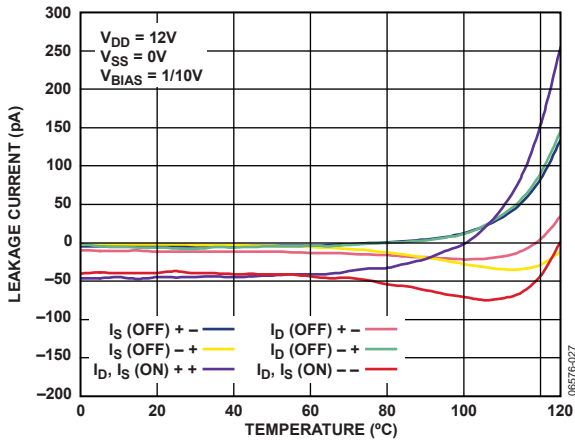

Figure 10. Leakage Currents as a Function of Temperature, Single Supply

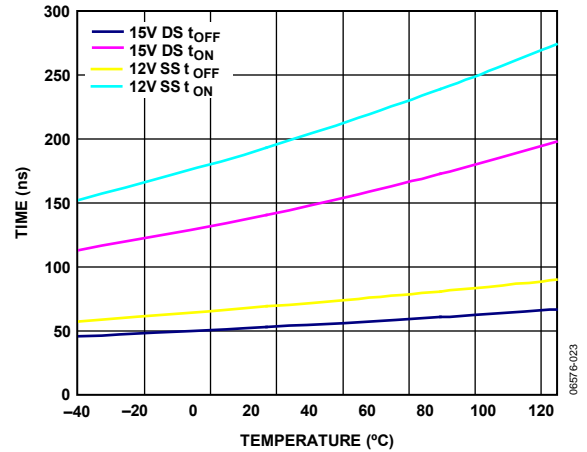

Figure 13.  $T_{ON}/T_{OFF}$  Times vs. Temperature

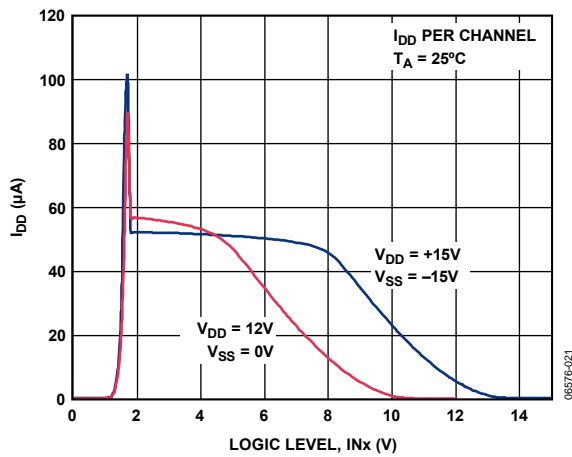

Figure 11.  $I_{DD}$  vs. Logic Level

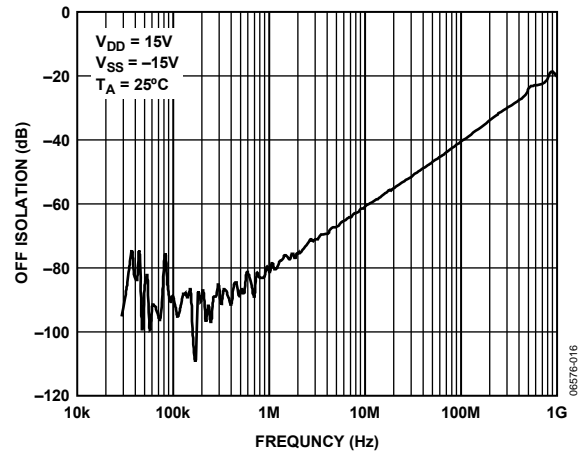

Figure 14. Off Isolation vs. Frequency



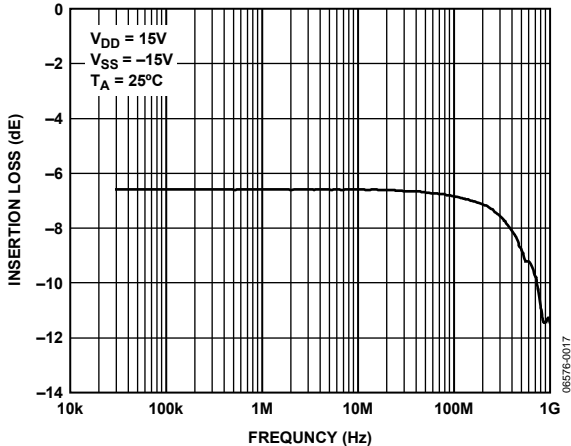

Figure 15. On Response vs. Frequency

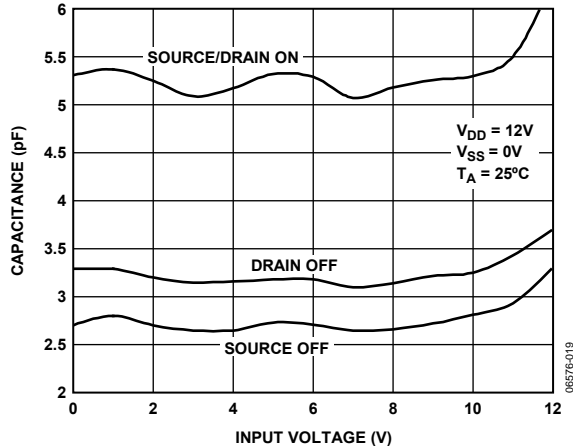

Figure 18. Capacitance vs. Input Voltage, Single Supply

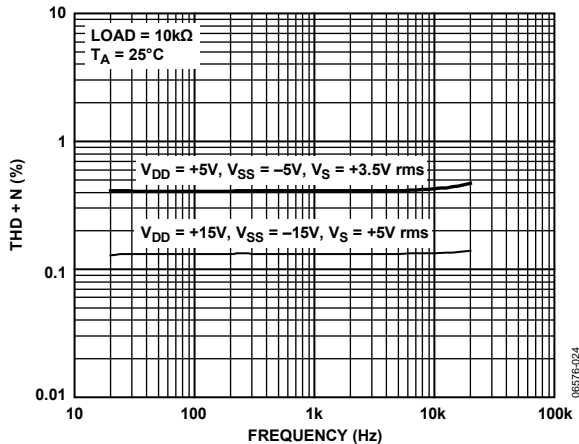

Figure 16. THD + N vs. Frequency

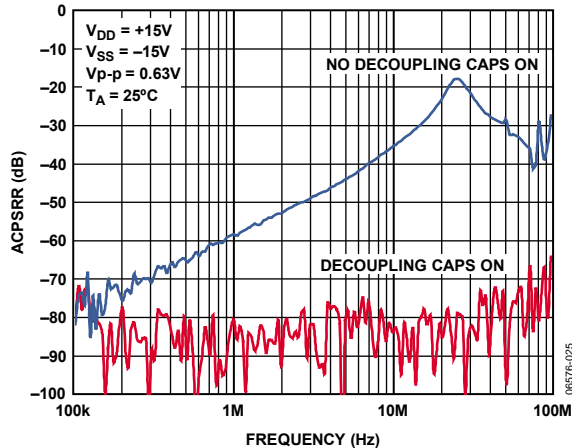

Figure 19. ACPSRR vs. Frequency

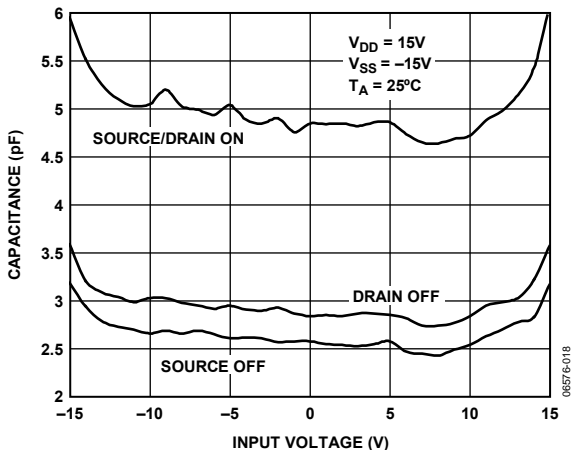

Figure 17. Capacitance vs. Input Voltage, Dual Supply

## TEST CIRCUITS

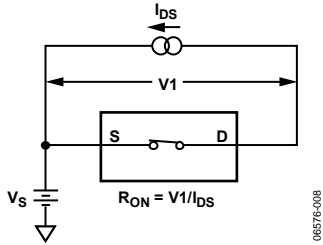

Figure 20. On Resistance

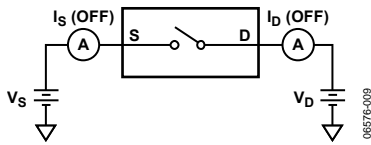

Figure 21. Off Leakage

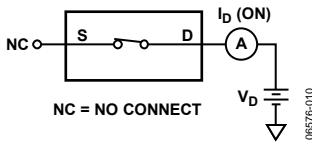

Figure 22. On Leakage

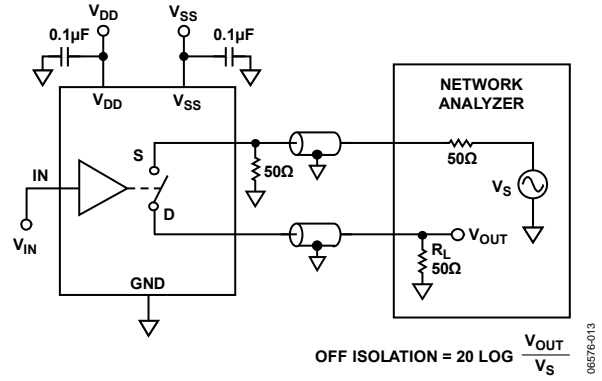

Figure 23. Off Isolation

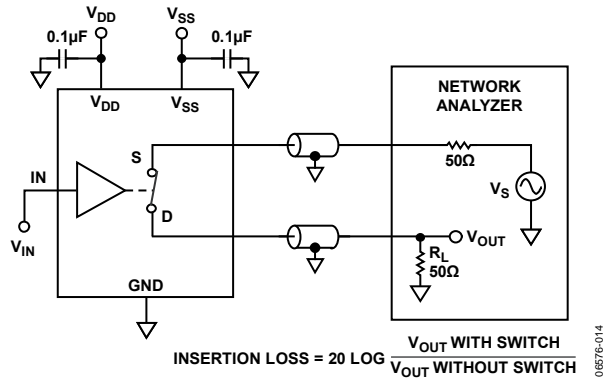

Figure 24. Bandwidth

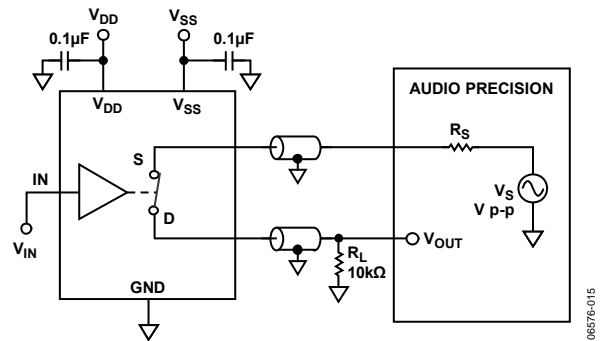

Figure 25. THD + Noise

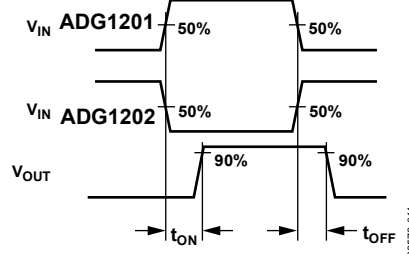
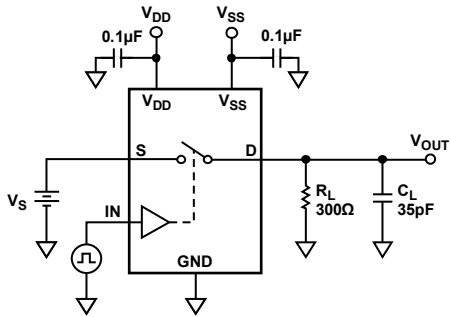

Figure 26. Switching Times

06576-011

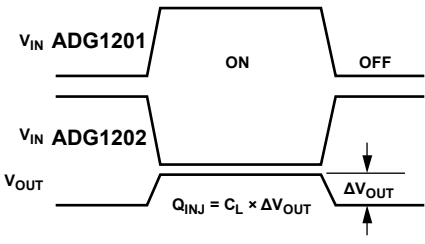
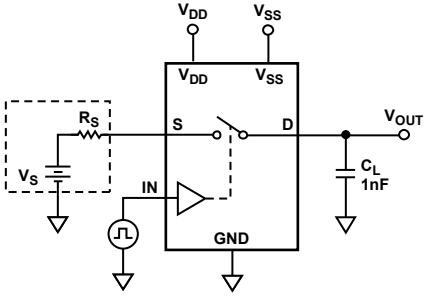

Figure 27. Charge Injection

06576-012

## TERMINOLOGY

**I<sub>DD</sub>**

The positive supply current.

**I<sub>SS</sub>**

The negative supply current.

**V<sub>D</sub> (V<sub>S</sub>)**

The analog voltage on Terminal D and Terminal S.

**R<sub>ON</sub>**

The ohmic resistance between D and S.

**R<sub>FLAT(ON)</sub>**

Flatness is defined as the difference between the maximum and minimum value of on resistance, as measured over the specified analog signal range.

**I<sub>S</sub> (Off)**

The source leakage current with the switch off.

**I<sub>D</sub> (Off)**

The drain leakage current with the switch off.

**I<sub>D</sub>, I<sub>S</sub> (On)**

The channel leakage current with the switch on.

**V<sub>INL</sub>**

The maximum input voltage for Logic 0.

**V<sub>INH</sub>**

The minimum input voltage for Logic 1.

**I<sub>INL</sub> (I<sub>INH</sub>)**

The input current of the digital input.

**C<sub>S</sub> (Off)**

The off switch source capacitance, measured with reference to ground.

**C<sub>D</sub> (Off)**

The off switch drain capacitance, measured with reference to ground.

**C<sub>D</sub>, C<sub>S</sub> (On)**

The on switch capacitance, measured with reference to ground.

**C<sub>IN</sub>**

The digital input capacitance.

**t<sub>ON</sub>**

The delay between applying the digital control input and the output switching on. See Figure 26.

**t<sub>OFF</sub>**

The delay between applying the digital control input and the output switching off. See Figure 26.

**Charge Injection**

A measure of the glitch impulse transferred from the digital input to the analog output during switching.

**Off Isolation**

A measure of unwanted signal coupling through an off switch.

**Crosstalk**

A measure of unwanted signal that is coupled through from one channel to another as a result of parasitic capacitance.

**Bandwidth**

The frequency at which the output is attenuated by 3 dB.

**On Response**

The frequency response of the on switch.

**Insertion Loss**

The loss due to the on resistance of the switch.

**THD + N**

The ratio of the harmonic amplitude plus noise of the signal to the fundamental.

**ACPSRR (AC Power Supply Rejection Ratio)**

Measures the ability of a part to avoid coupling noise and spurious signals that appear on the supply voltage pin to the output of the switch. The dc voltage on the device is modulated by a sine wave of 0.62 V p-p. The ratio of the amplitude of signal on the output to the amplitude of the modulation is the ACPSRR.

**OUTLINE DIMENSIONS**

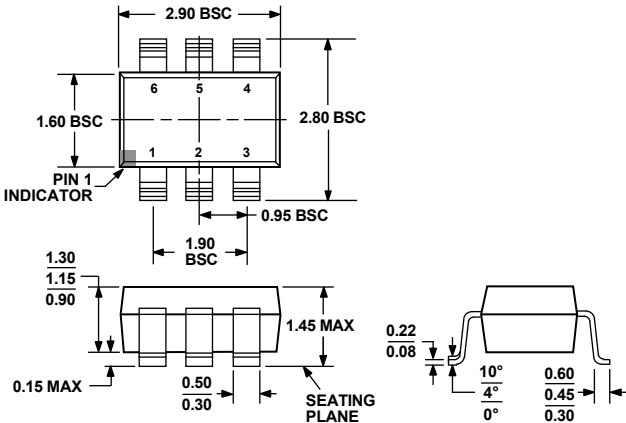

COMPLIANT TO JEDEC STANDARDS MO-178-AB  
 Figure 28. 6-Lead Small Outline Transistor Package [SOT-23]  
 (RJ-6)  
 Dimensions shown in millimeters

**ORDERING GUIDE**

Model	Temperature Range	Package Description	Package Option	Branding
ADG1201BRJZ-R2 <sup>1</sup>	-40°C to +125°C	6-Lead Small Outline Transistor Package [SOT-23]	RJ-6	S25
ADG1201BRJZ-REEL7 <sup>1</sup>	-40°C to +125°C	6-Lead Small Outline Transistor Package [SOT-23]	RJ-6	S25
ADG1202BRJZ-R2 <sup>1</sup>	-40°C to +125°C	6-Lead Small Outline Transistor Package [SOT-23]	RJ-6	S26
ADG1202BRJZ-REEL7 <sup>1</sup>	-40°C to +125°C	6-Lead Small Outline Transistor Package [SOT-23]	RJ-6	S26

<sup>1</sup> Z = RoHS Compliant Part.

**NOTES**

**NOTES**

**NOTES**