



DESCRIPTION

- 30.60mm (1.2")Single digit numeric display series.
- Standard brightness.
- Low current operation.
- Excellent character appearance.
- Easy mounting on P.C.boards or sockets

Package Dimensions &Internal Circuit Diagram

FYS-12011 Series

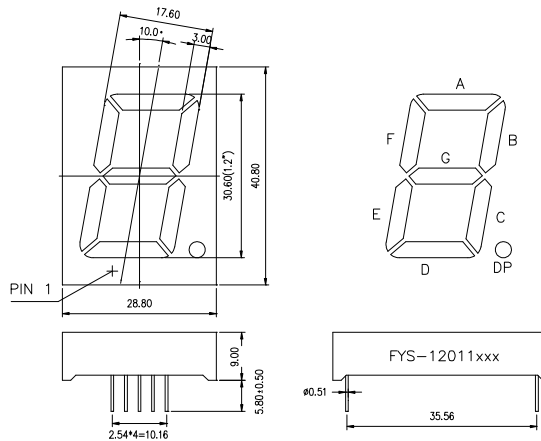

FYS-12011AEG

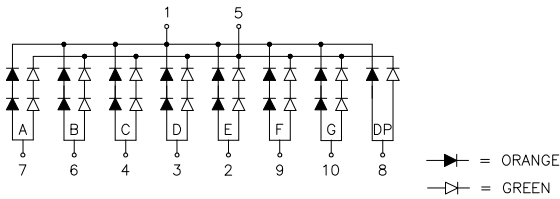

FYS-12011BEG

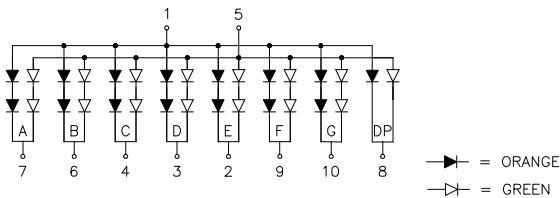

Notes:

- All dimensions are in millimeters (inches)
- Tolerance is $\pm 0.25(0.01)$ unless otherwise noted.
- Specifications are subject to change without notice.



PartNO.: FYS-12011A/BXX-XX

: Absolute maximum ratings (Ta=25°C)

Parameter	Symbol	Test Condition	Value		Unit
			Min	Max	
Reverse Voltage	VR	IR=30μA	5	-----	V
Forward Current	IF	-----	-----	30	mA
Power Dissipation	Pd	-----	-----	100	mW
Pulse Current	Ipeak	Duty=0.1mS, 1KHz	-----	150	mA
Operating Temperature	Topr	-----	-40	+85	° C
Storage Temperature	Tstr	-----	-40	+85	° C

■ **Description:**

• Color Code & Chip characteristics: (Test Condition: IF=20mA)

Emitting Color		Dice Material	Peak Wave Length (λp)	Spectral Line halfwidth(Δλ1/2)	Forward Voltage(VF) Unit:V		Luminous Intensity (lv) Unit:ucd
					Typ	Max	
H	Red	GaP/GaP	700nm	90nm	2.25	2.50	500
S	Hi Red	GaAlAs/GaAs,SH	660nm	20nm	1.85	2.20	3500
D	Super Red	GaAlAs/GaAs,DH	660nm	20nm	1.85	2.20	6000
UR	Ultra Red	GaAlAs/GaAs,DD H	660nm	20nm	1.85	2.20	12000
E	Orange	GaAsP/GaP	635nm	35nm	2.10	2.50	2500
Y	Yellow	GaAsP/GaP	585nm	35nm	2.10	2.50	2000
G	Green	GaP/GaP	570nm	30nm	2.20	2.50	2500

• -XX: Surface / Lens color:

Number	0	1	2	3	4	5
Ref Surface Color	White	Black	Gray	Red	Green	
Epoxy Color	Water clear	White diffused	Red Diffused	Green Diffused	Yellow Diffused	



PartNO.: FYS-12011A/BXX-XX

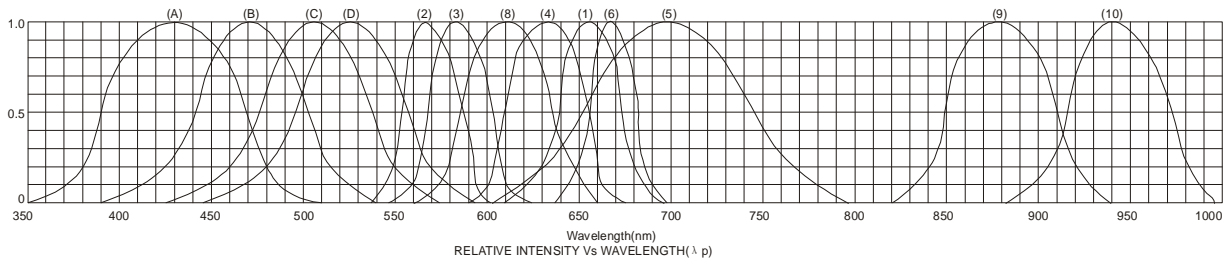

- | | |
|-------------------------------------------|--------------------------------------|
| (1) - GaAsP/GaAs 655nm/Red | (9) - GaAlAs 880nm |
| (2) - GaP 570nm/Yellow Green | (10) - GaAs/GaAs & GaAlAs/GaAs 940nm |
| (3) - GaAsP/GaP 585nm/Yellow | (A) - GaN/SiC 430nm/Blue |
| (4) - GaAsP/GaP 635nm/Orange & Hi-Eff Red | (B) - InGaN/SiC 470nm/Blue |
| (5) - GaP 700nm/Bright Red | (C) - InGaN/SiC 505nm/Ultra Green |
| (6) - GaAlAs/GaAs 660nm/Super Red | (D) - InGaAl/SiC 525nm/Ultra Green |
| (8) - GaAsP/GaP 610nm/Super Red | |

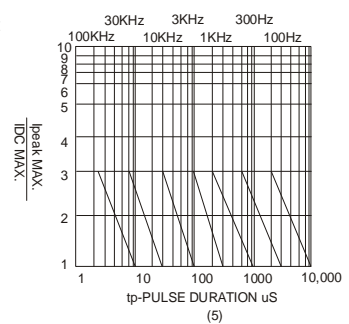
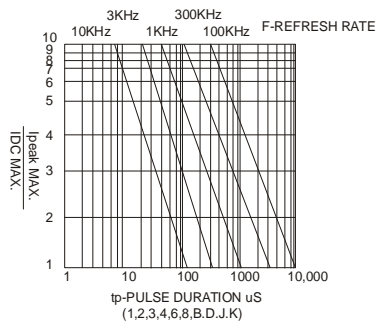
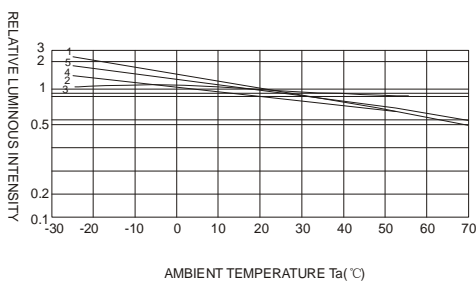
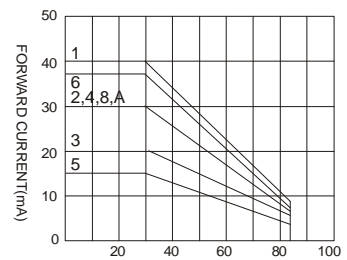
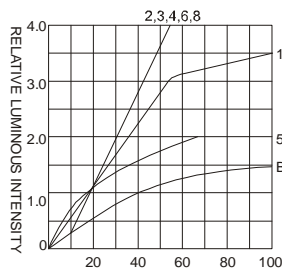
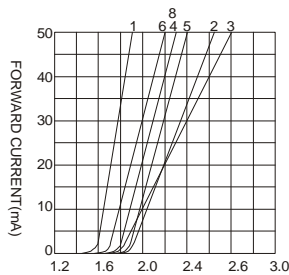

NOTE:25°C free air temperature unless otherwise specified



**NINGBO FORYARD OPTO
ELECTRONICS CO.,LTD.**

LED DIGIT DISPLAY

PartNO.: FYS-12011A/BXX-XX

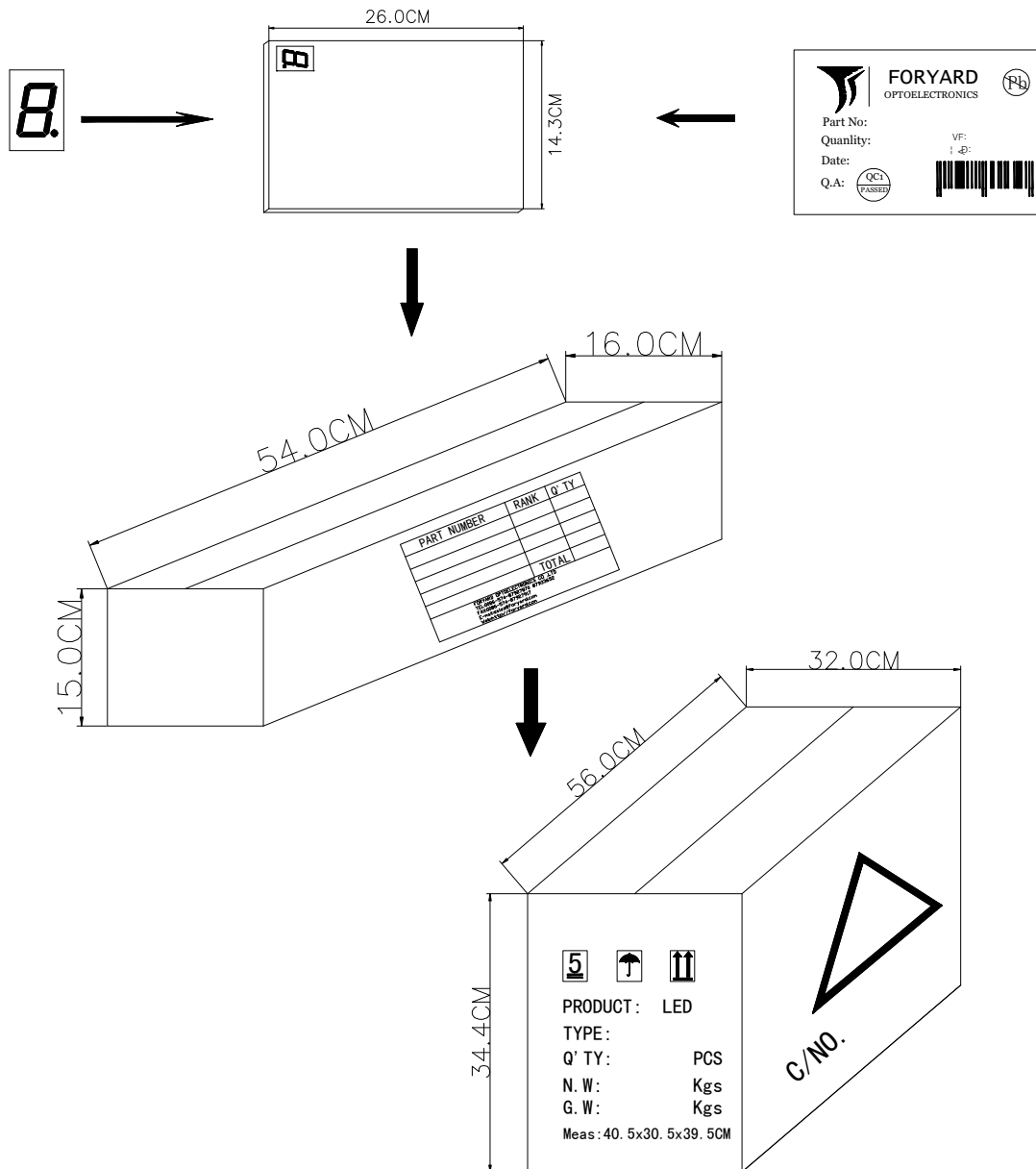

tapy	QTY/foam(pcs)	QTY /Bundle (pcs)	QTY /CARTONDimension
FYS-12011A/Bxx-xx	5*6=30	30*16=480	480*4=1920

ADD: NO.115 QiXin Road NingBo Zhejiang China ZIP: 315051
 TEL: 0086-574-87927870 87933652 FAX:0086-574-87927917
[Http://www.foryard.com](http://www.foryard.com) E-mail:sales@foryard.com