

### Typical Applications

The HMC311ST89 / HMC311ST89E is an ideal RF/IF gain block or LO buffer amplifier for:

- Cellular / PCS / 3G
- Fixed Wireless & WLAN
- CATV & Cable Modem
- Microwave Radio

### Features

- P1dB Output Power: +15.5 dBm
- Output IP3: +31.5 dBm
- Gain: 16 dB
- 50 Ohm I/O's
- Industry Standard SOT89 Package
- Included in the HMC-DK001 Designer's Kit

### Functional Diagram

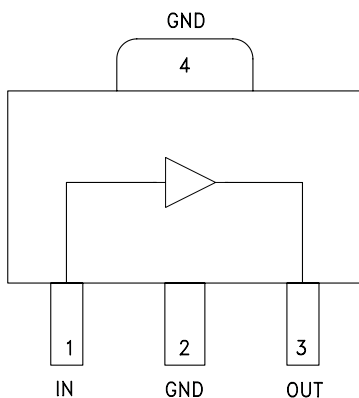

### General Description

The HMC311ST89 & HMC311ST89E are GaAs InGaP Heterojunction Bipolar Transistor (HBT) Gain Block MMIC SMT DC to 6 GHz amplifiers. Packaged in an industry standard SOT89, the amplifier can be used as either a cascadable 50 Ohm gain stage or to drive the LO of HMC mixers with up to +16.5 dBm output power. The HMC311ST89 & HMC311ST89E offer 16 dB of gain and an output IP3 of +31.5 dBm while requiring only 54 mA from a +5V supply. The Darlington feedback pair used results in reduced sensitivity to normal process variations and yields excellent gain stability over temperature while requiring a minimal number of external bias components.

### Electrical Specifications, $V_s = 5.0\text{ V}$ , $R_{bias} = 22\text{ Ohm}$ , $T_A = +25^\circ\text{ C}$

Parameter		Min.	Typ.	Max.	Units
Gain	DC - 1.0 GHz	14.0	16.0		dB
	1.0 - 4.0 GHz	13.0	15.0		dB
	4.0 - 6.0 GHz	12.5	14.5		dB
Gain Variation Over Temperature	DC - 2.0 GHz		0.004	0.007	dB/ °C
	2.0 - 4.0 GHz		0.007	0.012	dB/ °C
	4.0 - 6.0 GHz		0.012	0.016	dB/ °C
Return Loss Input / Output	DC - 2.0 GHz		8		dB
	2.0 - 5.0 GHz		7		dB
	5.0 - 6.0 GHz		8		dB
Reverse Isolation	DC - 6.0 GHz		20		dB
Output Power for 1 dB Compression (P1dB)	DC - 2.0 GHz	13.5	15.5		dBm
	2.0 - 4.0 GHz	12.0	15.0		dBm
	4.0 - 6.0 GHz	10.0	13.0		dBm
Output Third Order Intercept (IP3)	DC - 1.0 GHz		31.5		dBm
	1.0 - 2.0 GHz		30		dBm
	2.0 - 4.0 GHz		27		dBm
	4.0 - 6.0 GHz		24		dBm
Noise Figure	DC - 4.0 GHz		4.5		dB
	4.0 - 6.0 GHz		5		dB
Supply Current (Icq)			54		mA

Note: Data taken with broadband bias tee on device output.



**InGaP HBT GAIN BLOCK  
MMIC AMPLIFIER, DC - 6.0 GHz**

**Broadband Gain & Return Loss**

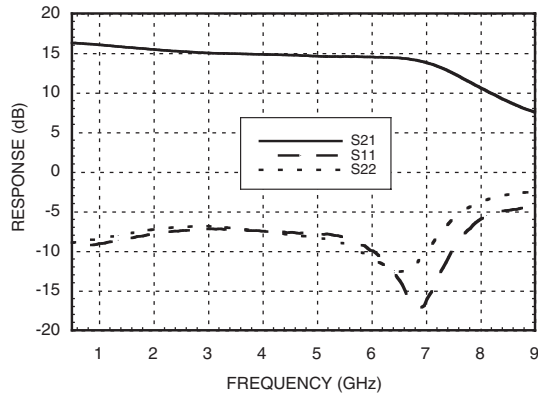

**Gain vs. Temperature**

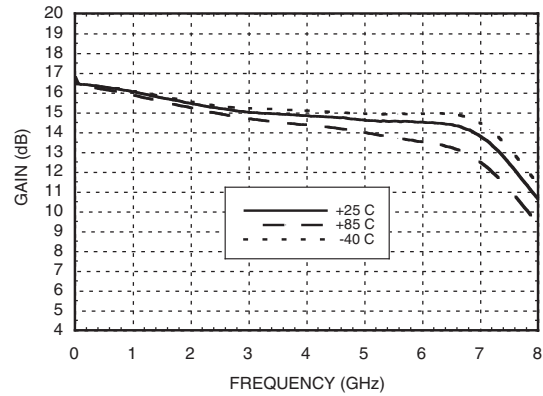

**Input Return Loss vs. Temperature**

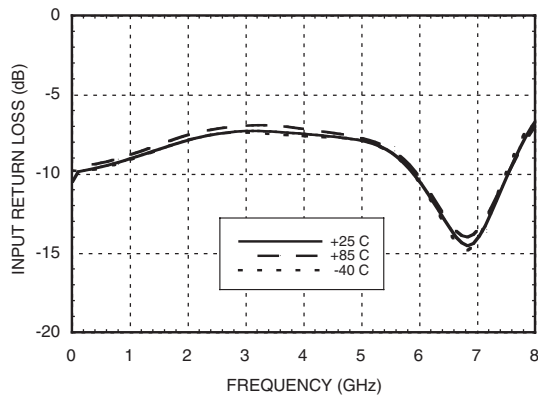

**Output Return Loss vs. Temperature**

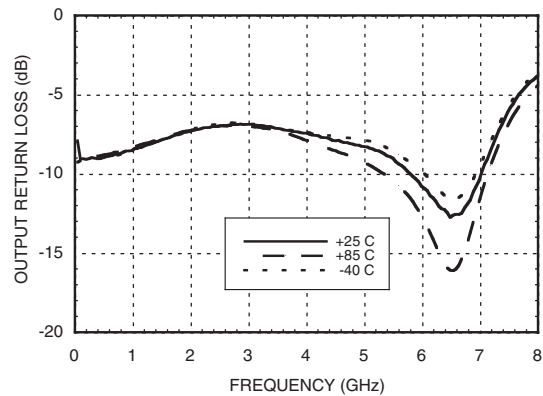

**Reverse Isolation vs. Temperature**

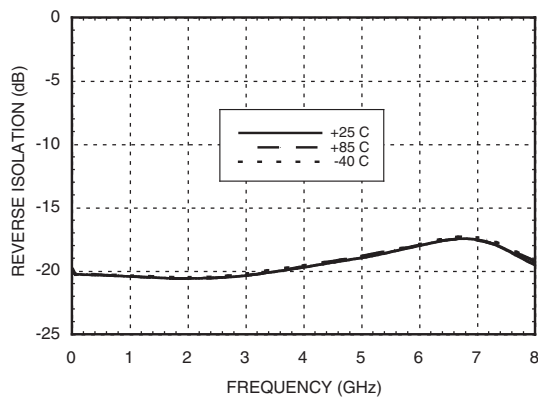

**Noise Figure vs. Temperature**

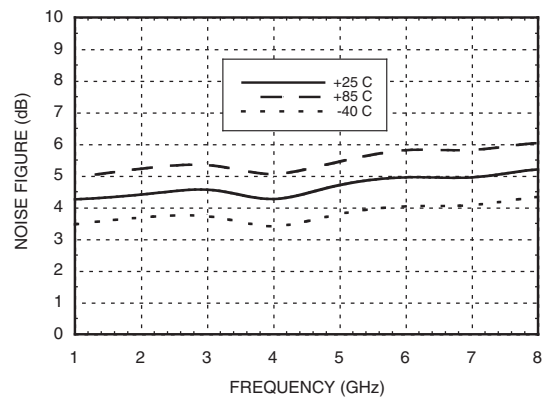

**P1dB vs. Temperature**

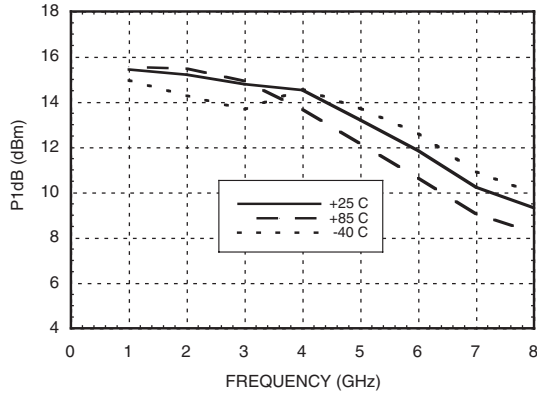

**Psat vs. Temperature**

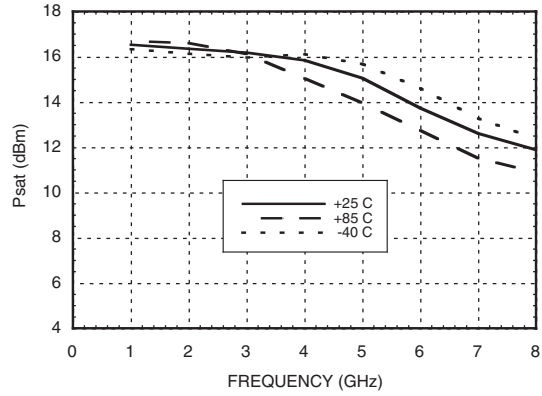

**Power Compression @ 1 GHz**

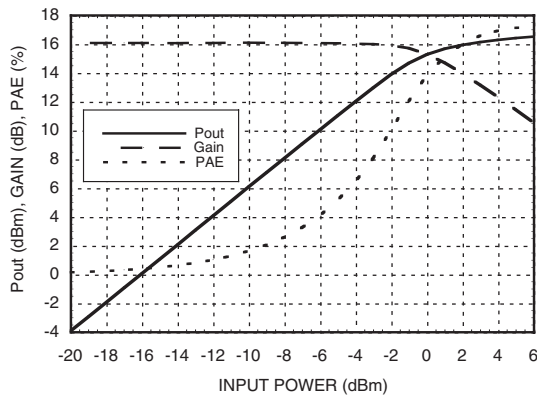

**Power Compression @ 6 GHz**

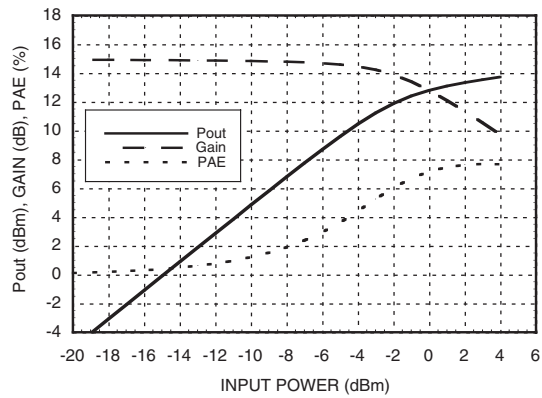

**Output IP3 vs. Temperature**

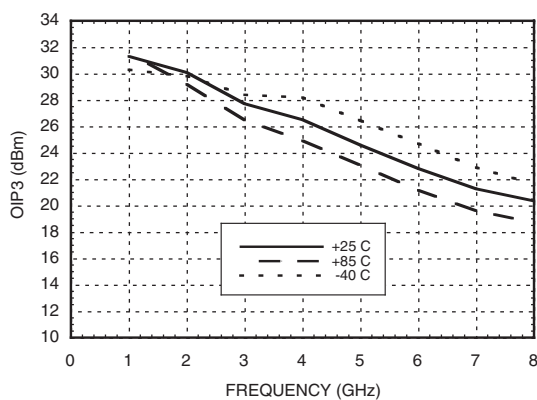

**Gain, Power, OIP3 & Supply Current vs. Supply Voltage @ 1 GHz**

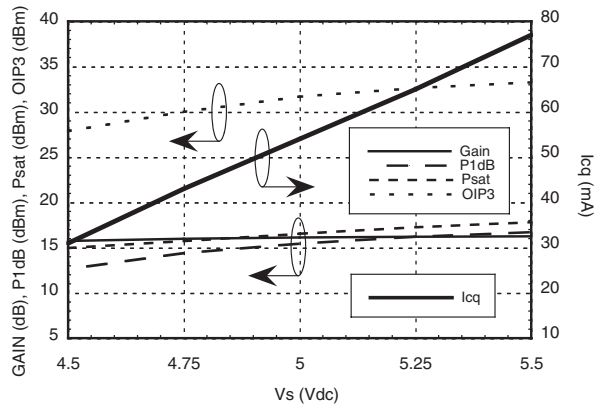

### Absolute Maximum Ratings

Collector Bias Voltage (Vcc)	+7 Volts
RF Input Power (RFIn)(Vcc = +3.9 Vdc)	+10 dBm
Junction Temperature	150 °C
Continuous P <sub>diss</sub> (T = 85 °C) (derate 5.21 mW/°C above 85 °C)	0.34 W
Thermal Resistance (junction to lead)	191 °C/W
Storage Temperature	-65 to +150 °C
Operating Temperature	-40 to +85 °C



ELECTROSTATIC SENSITIVE DEVICE  
OBSERVE HANDLING PRECAUTIONS

### Outline Drawing

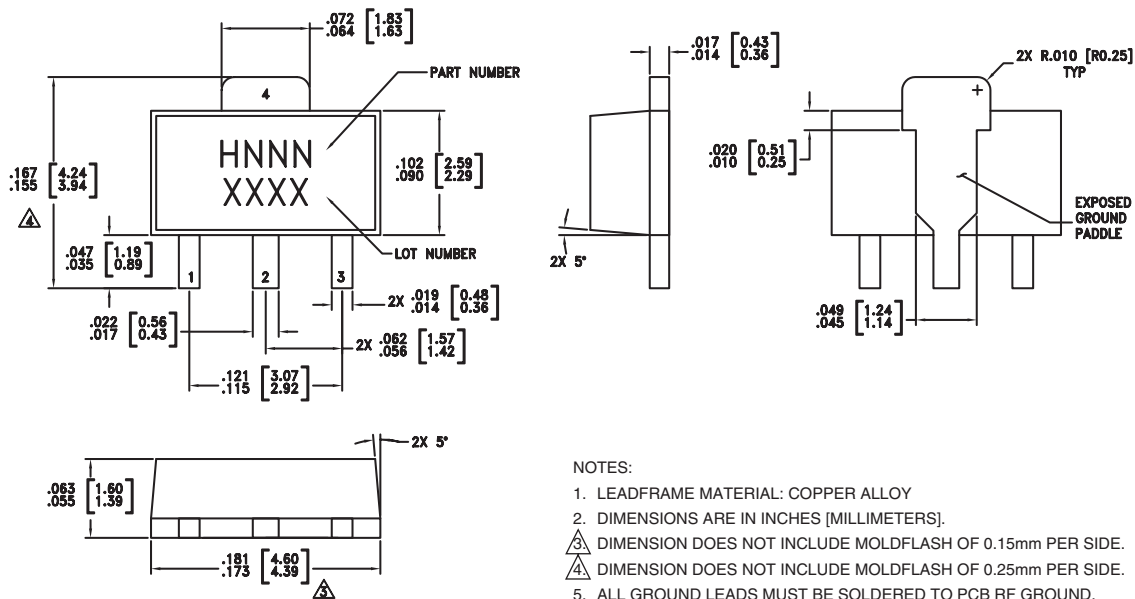

### Package Information



Part Number	Package Body Material	Lead Finish	MSL Rating	Package Marking <sup>[3]</sup>
HMC311ST89	Low Stress Injection Molded Plastic	Sn/Pb Solder	MSL1 <sup>[1]</sup>	H311 XXXX
HMC311ST89E	RoHS-compliant Low Stress Injection Molded Plastic	100% matte Sn	MSL1 <sup>[2]</sup>	H311 XXXX

[1] Max peak reflow temperature of 235 °C

[2] Max peak reflow temperature of 260 °C

[3] 4-Digit lot number XXXX

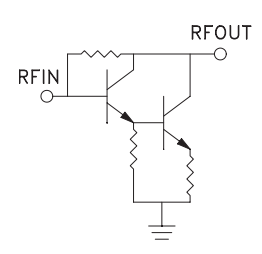
### Pin Descriptions

Pin Number	Function	Description	Interface Schematic
1	RFIN	This pin is DC coupled. An off chip DC blocking capacitor is required.	
3	RFOUT	RF output and DC Bias for the output stage.	
2, 4	GND	These pins and package bottom must be connected to RF/DC ground.	

### Application Circuit

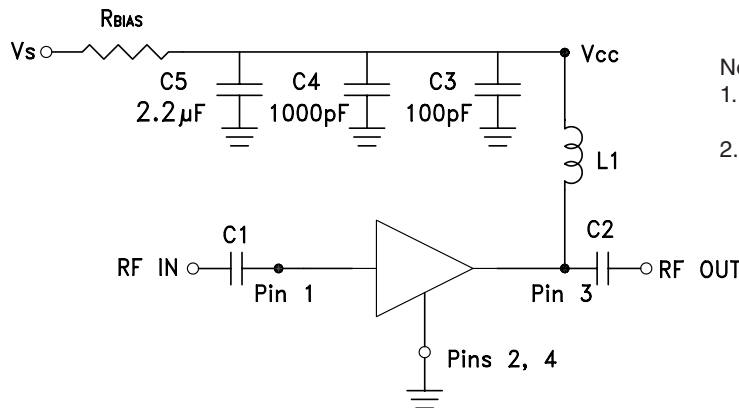

Note:

1. Select R<sub>bias</sub> to achieve I<sub>cq</sub> using equation below, R<sub>bias</sub> ≥ 22 Ohm.
2. External blocking capacitors are required on RFIN and RFOUT.

$$I_{cq} = \frac{V_s - 3.9}{R_{bias}}$$

### Recommended Component Values

Component	Frequency (MHz)							
	50	900	1900	2200	2400	3500	5200	5800
L1	270 nH	56 nH	18 nH	18 nH	15 nH	8.2 nH	3.3 nH	3.3 nH
C1, C2	0.01 μF	100 pF	100 pF	100 pF	100 pF	100 pF	100 pF	100 pF

**Evaluation PCB**

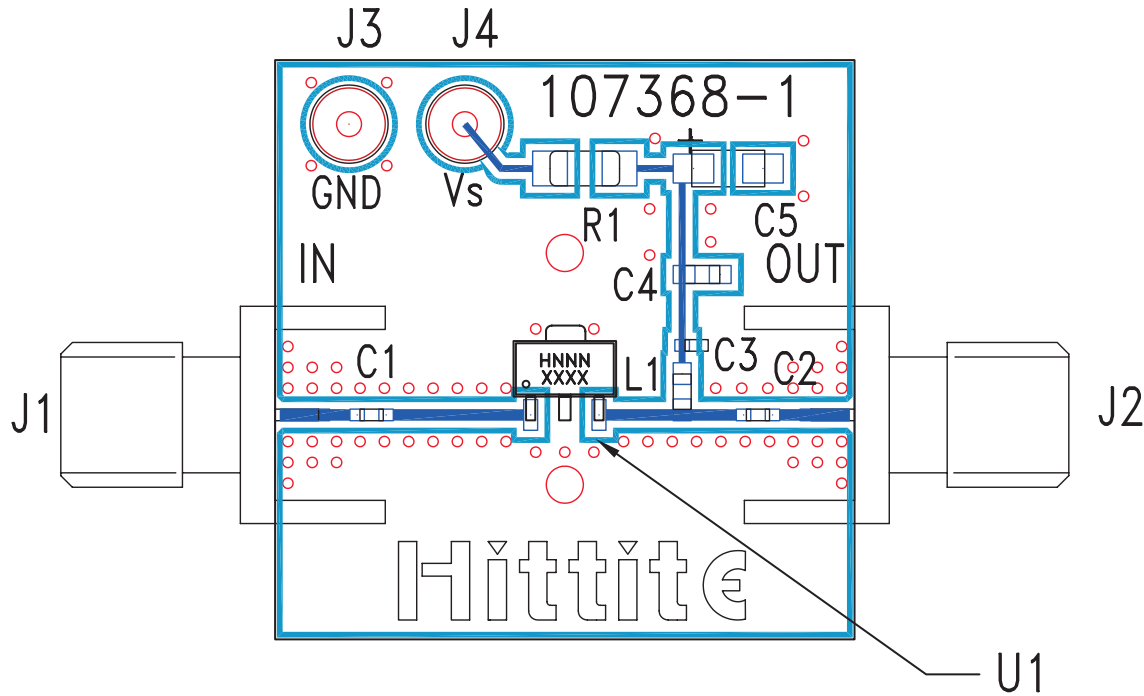

**List of Materials for Evaluation PCB 108313 [1]**

Item	Description
J1 - J2	PCB Mount SMA Connector
J3 - J4	DC Pin
C1, C2	Capacitor, 0402 Pkg.
C3	100 pF Capacitor, 0402 Pkg.
C4	1000 pF Capacitor, 0603 Pkg.
C5	2.2 $\mu$ F Capacitor, Tantalum
R1	Resistor, 0805 Pkg.
L1	Inductor, 0603 Pkg.
U1	HMC311ST89 / HMC311ST89E
PCB [2]	107368 Evaluation PCB

[1] Reference this number when ordering complete evaluation PCB

[2] Circuit Board Material: Rogers 4350

The circuit board used in the final application should use RF circuit design techniques. Signal lines should have 50 ohm impedance while the package ground leads and package bottom should be connected directly to the ground plane similar to that shown. A sufficient number of VIA holes should be used to connect the top and bottom ground planes. The evaluation board should be mounted to an appropriate heat sink. The evaluation circuit board shown is available from Hittite upon request.