

GaAs MMIC VOLTAGE-VARIABLE ATTENUATOR, DC - 20 GHz

Typical Applications

This attenuator is ideal for use as a VVA for DC - 20 GHz applications:

- Point-to-Point Radio
- VSAT Radio

Features

- Wide Bandwidth: DC - 20 GHz
- Low Phase Shift vs. Attenuation
- 32 dB Attenuation Range
- Die Size: 0.85 x 0.85 x 0.1 mm

Functional Diagram

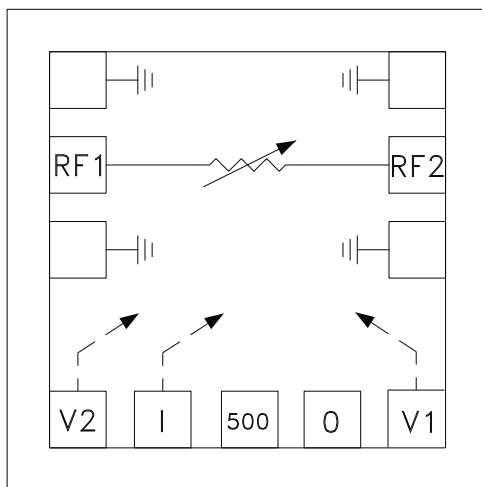

General Description

The HMC346 die is an absorptive Voltage Variable Attenuator (VVA) operating from DC - 20 GHz. It features an on-chip reference attenuator for use with an external op-amp to provide simple single voltage attenuation control, 0 to -3V. The device is ideal in designs where an analog DC control signal must control RF signal levels over a 30 dB amplitude range. For plastic packaged version, see the HMC346MS8G which operates from DC - 8 GHz.

Electrical Specifications, $T_A = +25^\circ \text{C}$, 50 ohm system

Parameter		Min.	Typ.	Max.	Units
Insertion Loss	DC - 12GHz:		1.7	2.3	dB
	DC - 20 GHz:		2.2	2.8	dB
Attenuation Range	DC - 12 GHz:	27	32		dB
	DC - 20 GHz:	22	25		dB
Return Loss	DC - 12 GHz:	6	10		dB
	12 - 20 GHz:	10	15		dB
Switching Characteristics	tRISE, tFALL (10/90% RF):		2		ns
	tON, tOFF (50% CTL to 10/90% RF):		8		ns
Input Power for 0.25 dB Compression (0.5 - 20 GHz)	Min. Atten:		+8		dBm
	Atten. >2 dB:		+4		dBm
Input Third Order Intercept (0.5 - 20 GHz) (Two-tone Input Power = -8 dBm Each Tone)	Min. Atten:		+25		dBm
	Atten. >2 dB:		+10		dBm

**GaAs MMIC VOLTAGE-VARIABLE
ATTENUATOR, DC - 20 GHz**

Insertion Loss vs. Temperature

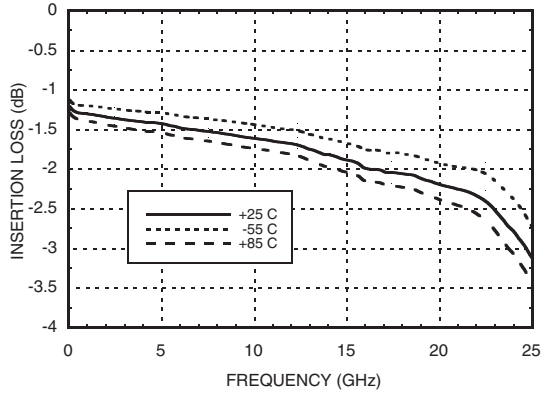

Relative Attenuation

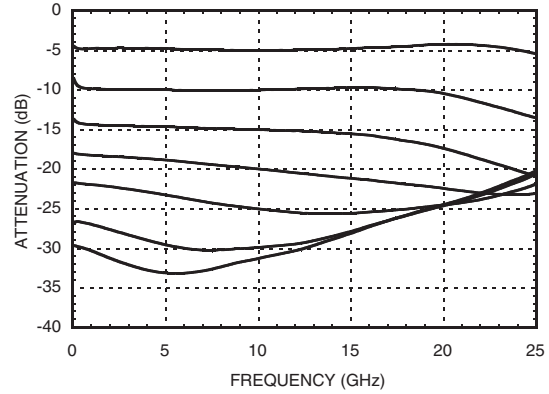

Return Loss vs. Attenuation

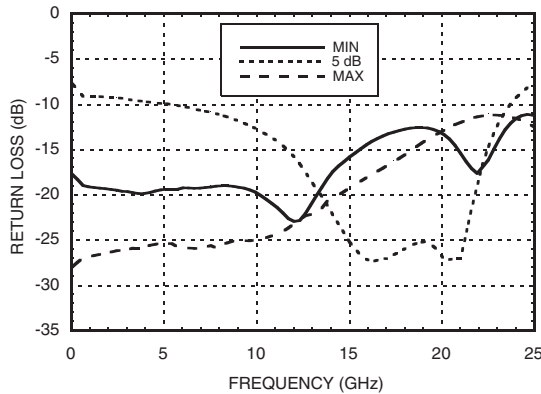

**Relative Attenuation vs.
Control Voltage @ 10 GHz**

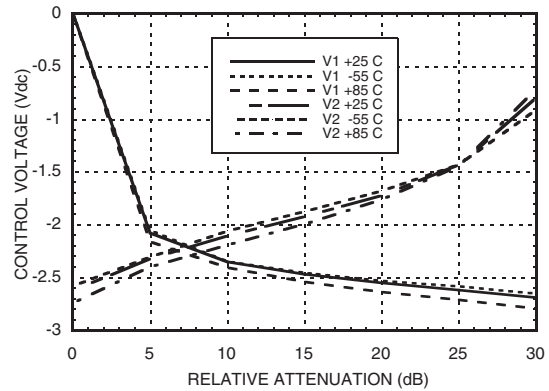

Relative Phase

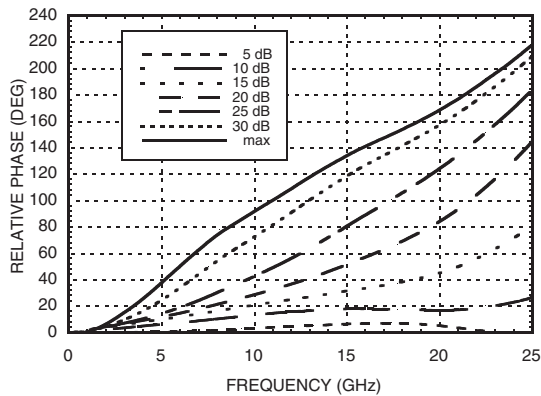

**Relative Attenuation vs.
Control Voltage @ 20 GHz**

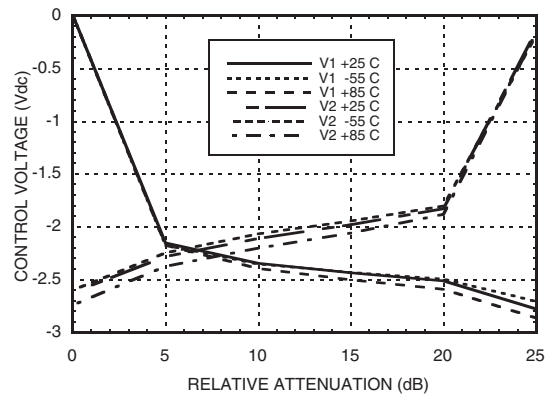

GaAs MMIC VOLTAGE-VARIABLE ATTENUATOR, DC - 20 GHz

Input IP3 vs. Attenuation*

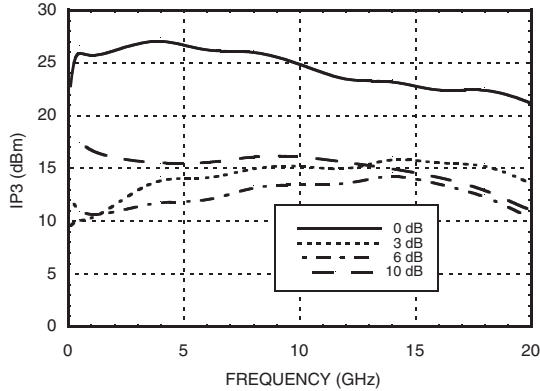

Input IP2 vs. Attenuation*

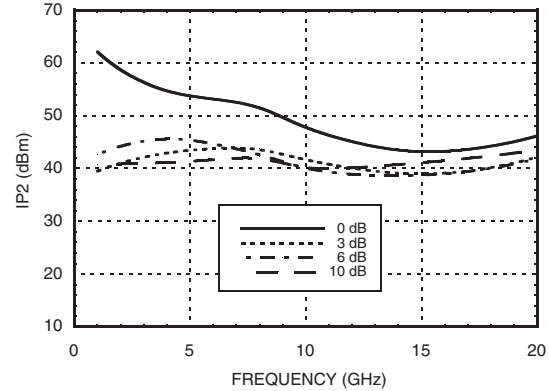

Input 0.25 dB Compression vs. Attenuation

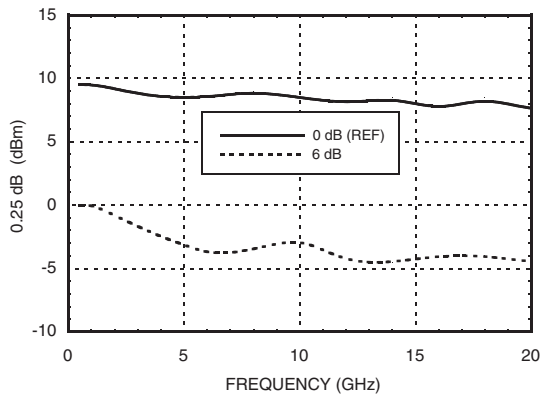

Input 1 dB Compression vs. Attenuation

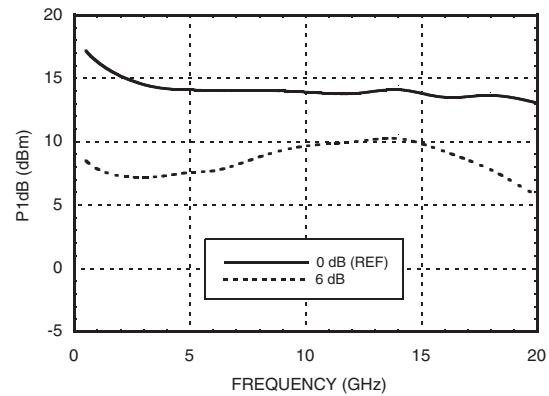

Second Harmonic vs. Attenuation*

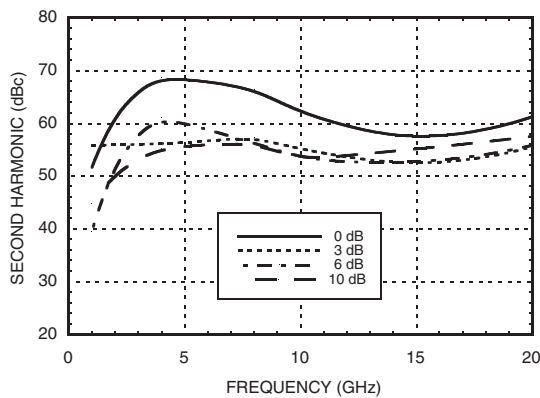

Absolute Maximum Ratings

RF Input Power	+18 dBm
Control Voltage Range	+1 to -5 Vdc
Storage Temperature	-65 to +150 °C
Operating Temperature	-55 to +85 °C



**ELECTROSTATIC SENSITIVE DEVICE
OBSERVE HANDLING PRECAUTIONS**

*Two-tone input power = -8 dBm each tone, 1 MHz spacing.

**GaAs MMIC VOLTAGE-VARIABLE
ATTENUATOR, DC - 20 GHz**

Outline Drawing

1. ALL DIMENSIONS ARE IN INCHES (MILLIMETERS).
2. TYPICAL BOND PAD IS .004" SQUARE.
3. TYPICAL BOND PAD SPACING IS .006" CENTER TO CENTER EXCEPT AS NOTED.
4. BACKSIDE METALIZATION: GOLD
5. BACKSIDE METAL IS GROUND
6. BOND PAD METALIZATION: GOLD

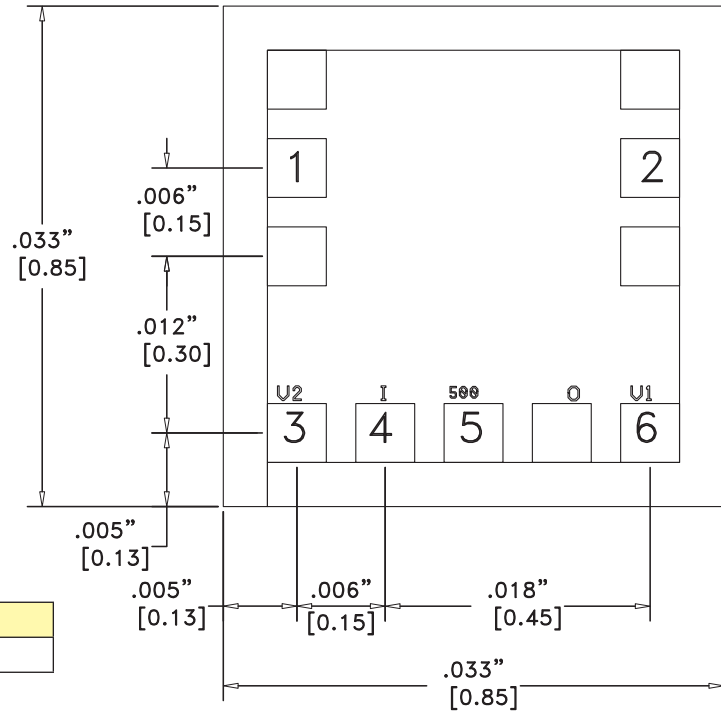



Die Packaging Information [1]

Standard	Alternate
GP-2	[2]

[1] Refer to the "Packaging Information" section for die packaging dimensions.
[2] For alternate packaging information contact Hittite Microwave Corporation.

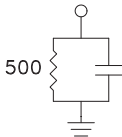
Pad Descriptions

Pad Number	Function	Description	Interface Schematic
1, 2	RF1 Input, RF2 Output	This pad is DC coupled and matched to 50 Ohm. Blocking capacitors are required if RF line potential is not equal to 0V.	
3, 6	V2, V1	Control Input (Master).	
4	I	Control Input (Slave).	
5	500	This pad must be DC grounded.	
	GND	Die bottom must be connected to RF ground.	

**GaAs MMIC VOLTAGE-VARIABLE
ATTENUATOR, DC - 20 GHz**

Single-Line Control Driver

External op-amp control circuit maintains impedance match while attenuation is varied. Input control ranges from 0 Volts (min. attenuation) to -3.0 Volts (max. attenuation.)

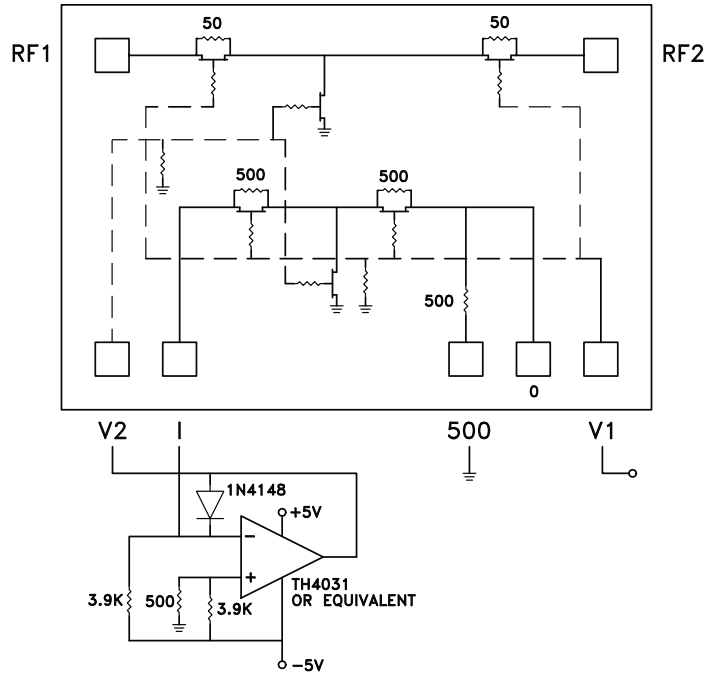

Assembly Diagram

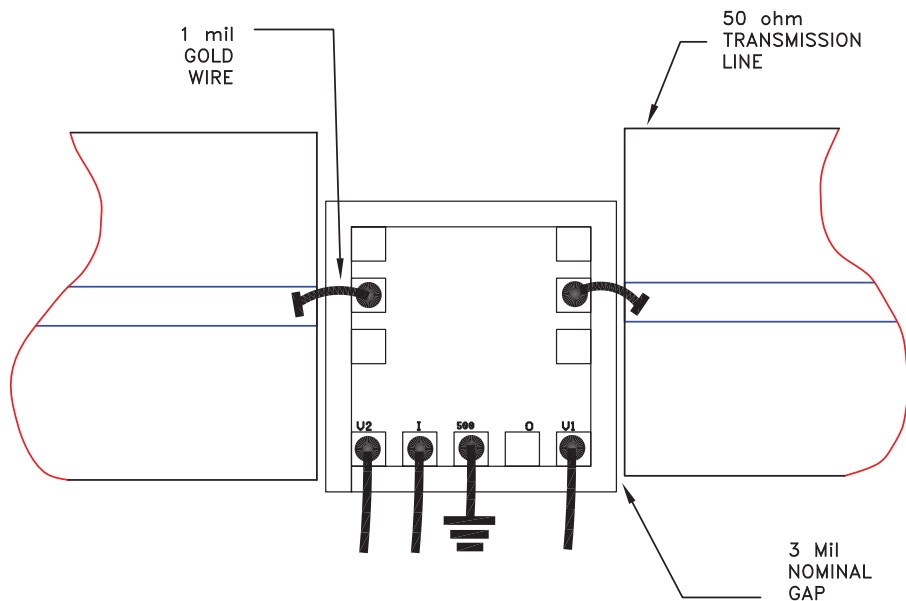

**GaAs MMIC VOLTAGE-VARIABLE
ATTENUATOR, DC - 20 GHz**

Mounting & Bonding Techniques for Millimeterwave GaAs MMICs

The die should be attached directly to the ground plane eutectically or with conductive epoxy (see HMC general Handling, Mounting, Bonding Note).

50 Ohm Microstrip transmission lines on 0.127mm (5 mil) thick alumina thin film substrates are recommended for bringing RF to and from the chip (Figure 1). If 0.254mm (10 mil) thick alumina thin film substrates must be used, the die should be raised 0.150mm (6 mils) so that the surface of the die is coplanar with the surface of the substrate. One way to accomplish this is to attach the 0.102mm (4 mil) thick die to a 0.150mm (6 mil) thick molybdenum heat spreader (moly-tab) which is then attached to the ground plane (Figure 2).

Microstrip substrates should be brought as close to the die as possible in order to minimize bond wire length. Typical die-to-substrate spacing is 0.076mm to 0.152 mm (3 to 6 mils).

Handling Precautions

Follow these precautions to avoid permanent damage.

Storage: All bare die are placed in either Waffle or Gel based ESD protective containers, and then sealed in an ESD protective bag for shipment. Once the sealed ESD protective bag has been opened, all die should be stored in a dry nitrogen environment.

Cleanliness: Handle the chips in a clean environment. DO NOT attempt to clean the chip using liquid cleaning systems.

Static Sensitivity: Follow ESD precautions to protect against ESD strikes.

Transients: Suppress instrument and bias supply transients while bias is applied. Use shielded signal and bias cables to minimize inductive pick-up.

General Handling: Handle the chip along the edges with a vacuum collet or with a sharp pair of bent tweezers. The surface of the chip has fragile air bridges and should not be touched with vacuum collet, tweezers, or fingers.

Mounting

The chip is back-metallized and can be die mounted with AuSn eutectic preforms or with electrically conductive epoxy. The mounting surface should be clean and flat.

Eutectic Die Attach: A 80/20 gold tin preform is recommended with a work surface temperature of 255 deg. C and a tool temperature of 265 deg. C. When hot 90/10 nitrogen/hydrogen gas is applied, tool tip temperature should be 290 deg. C. DO NOT expose the chip to a temperature greater than 320 deg. C for more than 20 seconds. No more than 3 seconds of scrubbing should be required for attachment.

Epoxy Die Attach: Apply a minimum amount of epoxy to the mounting surface so that a thin epoxy fillet is observed around the perimeter of the chip once it is placed into position. Cure epoxy per the manufacturer's schedule.

Wire Bonding

Ball or wedge bond with 0.025mm (1 mil) diameter pure gold wire. Thermosonic wirebonding with a nominal stage temperature of 150 deg. C and a ball bonding force of 40 to 50 grams or wedge bonding force of 18 to 22 grams is recommended. Use the minimum level of ultrasonic energy to achieve reliable wirebonds. Wirebonds should be started on the chip and terminated on the package or substrate. All bonds should be as short as possible <0.31mm (12 mils).

