

GaAs PHEMT MMIC MEDIUM POWER AMPLIFIER, 7.0 - 15.5 GHz

Typical Applications

The HMC441LM1 is a medium PA for:

- Point-to-Point Radios
- Point-to-Multi-Point Radios
- VSAT
- LO Driver for HMC Mixers
- Military EW & ECM

Features

- Gain: 15 dB
- Saturated Power: +21.5 dBm @ 27% PAE
- Single Supply Voltage:
+5V w/ Optional Gate Bias
- 50 Ohms Matched Input/Output
- Leadless SMT Package, 25mm²

Functional Diagram

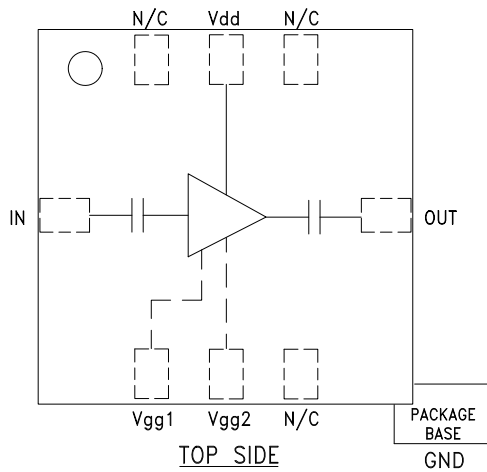

Vgg1, Vgg2: Optional Gate Bias

General Description

The HMC441LM1 is a broadband 7 to 15.5 GHz GaAs PHEMT MMIC Medium Power Amplifier in an SMT leadless chip carrier package. The amplifier provides 15 dB of gain, 21.5 dBm of saturated power at 27% PAE from a +5V supply voltage. An optional gate bias is provided to allow adjustment of gain, RF output power, and DC power dissipation. This 50 Ohm matched amplifier does not require any external components making it an ideal linear gain block or driver for HMC SMT mixers.

Electrical Specifications, $T_A = +25^\circ\text{C}$, $V_{dd} = 5\text{V}$, $V_{gg1} = V_{gg2} = \text{Open}$

Parameter	Min.	Typ.	Max.	Min.	Typ.	Max.	Min.	Typ.	Max.	Min.	Typ.	Max.	Units
Frequency Range	7.0 - 8.0			8.0 - 12.5			12.5 - 14.0			14.0 - 15.5			GHz
Gain	12.5	15		13.5	16		12.5	15		11	13.5		dB
Gain Variation Over Temperature		0.015	0.02		0.015	0.02		0.015	0.02		0.015	0.02	dB/°C
Input Return Loss		9			13			16			16		dB
Output Return Loss		14			17			20			17		dB
Output Power for 1 dB Compression (P1dB)	15.5	18.5		16	19		17	20		16	19		dBm
Saturated Output Power (Psat)		19.5			20.5			21.5			20.5		dBm
Output Third Order Intercept (IP3)		29			30			30			30		dBm
Noise Figure		4.5			4.5			4.5			4.5		dB
Supply Current (Idd)		90	115		90	115		90	115		90	115	mA



GaAs PHEMT MMIC MEDIUM POWER AMPLIFIER, 7 - 15.5 GHz

Broadband Gain & Return Loss

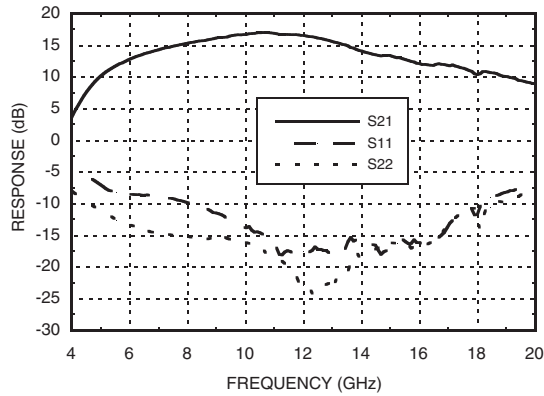

Gain vs. Temperature

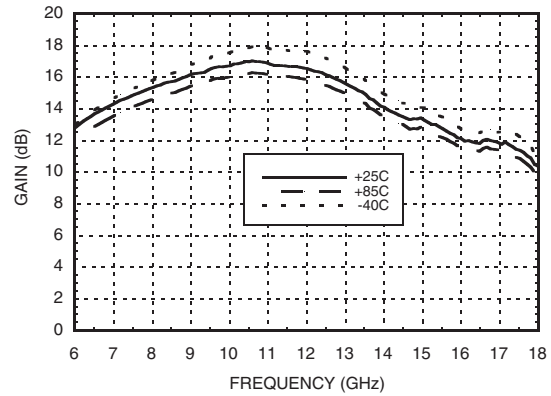

Input Return Loss vs. Temperature

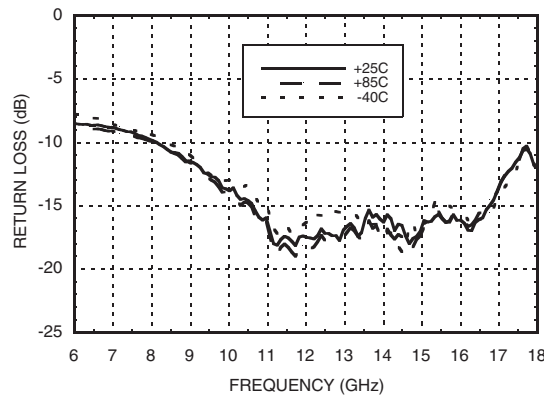

Output Return Loss vs. Temperature

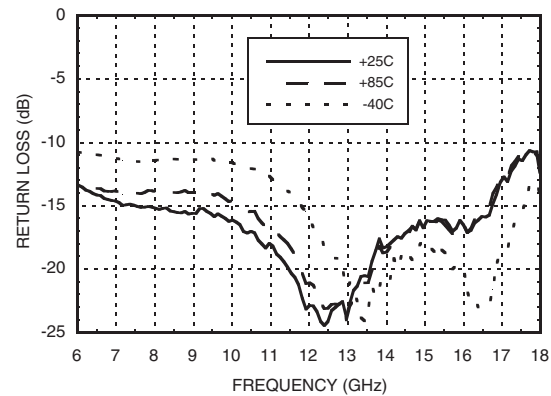

P1dB vs. Temperature

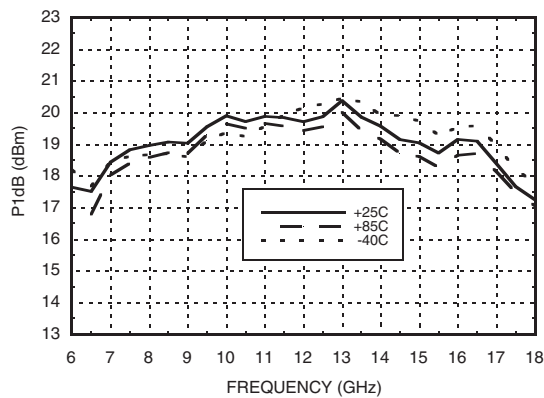

Psat vs. Temperature

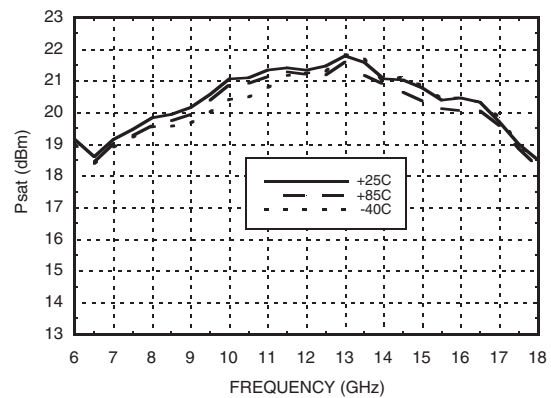

GaAs PHEMT MMIC MEDIUM POWER AMPLIFIER, 7 - 15.5 GHz

Power Compression @ 12 GHz

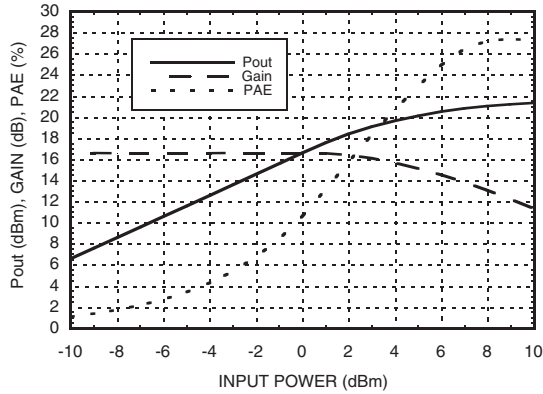

Output IP3 vs. Temperature

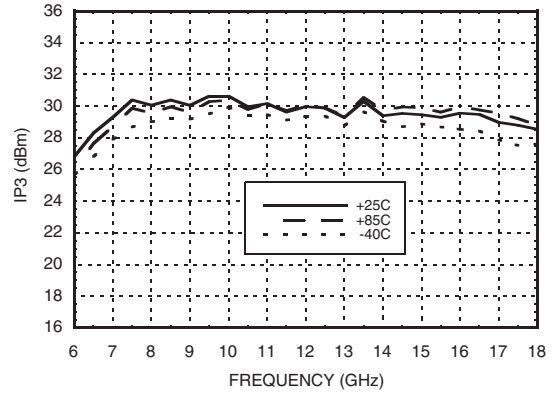

Gain, Power & Output IP3 vs. Supply Voltage @ 12 GHz

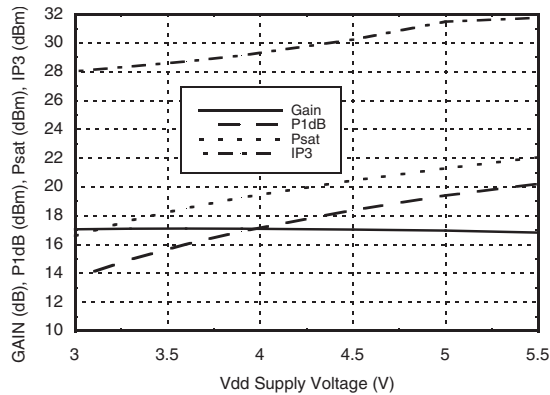

Gain, Power, Output IP3 & I_{dd} vs. Gate Voltage @ 12 GHz

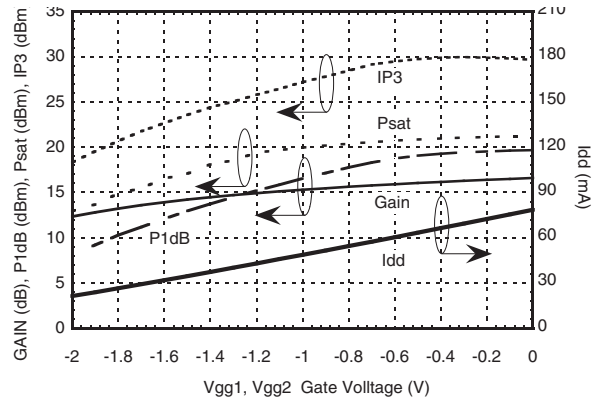

Noise Figure vs. Temperature

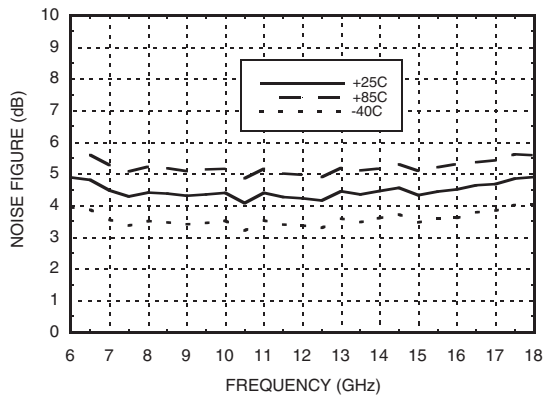

Reverse Isolation vs. Temperature

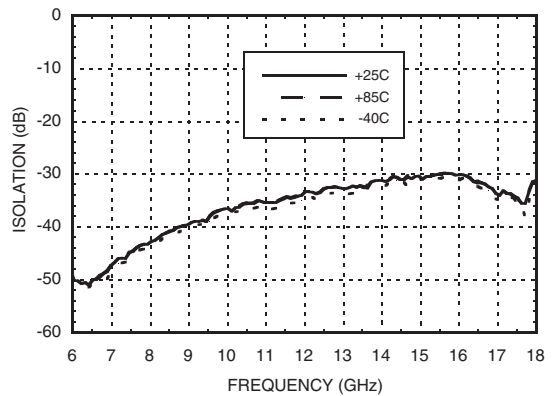

GaAs PHEMT MMIC MEDIUM POWER AMPLIFIER, 7 - 15.5 GHz

Absolute Maximum Ratings

Drain Bias Voltage (Vdd)	+5.5 Vdc
Gate Bias Voltage (Vgg1,Vgg2)	-8 to 0 Vdc
RF Input Power (RFIN) (Vdd = +5 Vdc)	+15 dBm
Channel Temperature	175 °C
Continuous Pdiss (T = 85 °C) (derate 6.7 mW/°C above 85 °C)	0.6 W
Thermal Resistance (channel to ground paddle)	149 °C/W
Storage Temperature	-65 to +150 °C
Operating Temperature	-40 to +85 °C

Typical Supply Current vs. Vdd

Vdd (V)	Idd (mA)
+5.5	92
+5.0	90
+4.5	88
+3.3	83
+3.0	82

Note: Amplifier will operate over full voltage range shown above



ELECTROSTATIC SENSITIVE DEVICE
OBSERVE HANDLING PRECAUTIONS

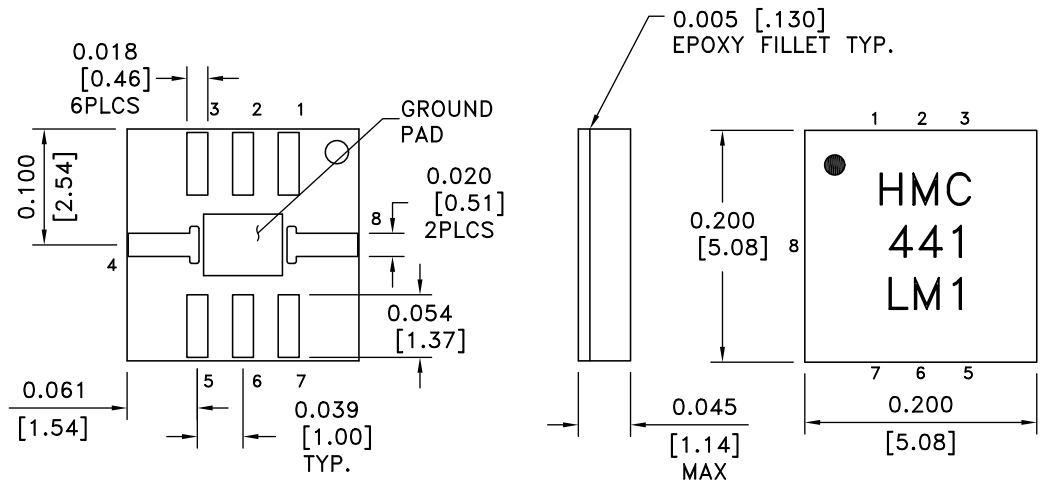

Outline Drawing



NOTES:

1. MATERIAL: PLASTIC
2. PLATING: GOLD OVER NICKEL
3. DIMENSIONS ARE IN INCHES [MILLIMETERS].
4. ALL TOLERANCES ARE ± 0.005 [± 0.13].
5. ALL GROUNDS MUST BE SOLDERED TO PCB RF GROUND.
6. • INDICATES PIN 1.

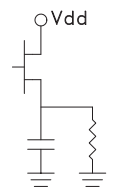
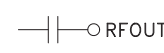
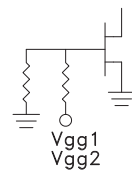
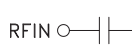
Pin Descriptions

Pin Number	Function	Description	Interface Schematic
1, 3, 5	N/C	This pin may be connected to RF ground.	
2	Vdd	Power Supply Voltage for the amplifier. An external bypass capacitor of 100 pF is recommended.	
4	RFOUT	This pin is AC coupled and matched to 50 Ohms.	
6, 7	Vgg2, Vgg1	Optional gate control for amplifier. If left open, the amplifier will run at standard current. Negative voltage applied will reduce current.	
8	RFIN	This pin is AC coupled and matched to 50 Ohms.	
	GND	Package bottom must be connected to RF ground.	

Evaluation PCB

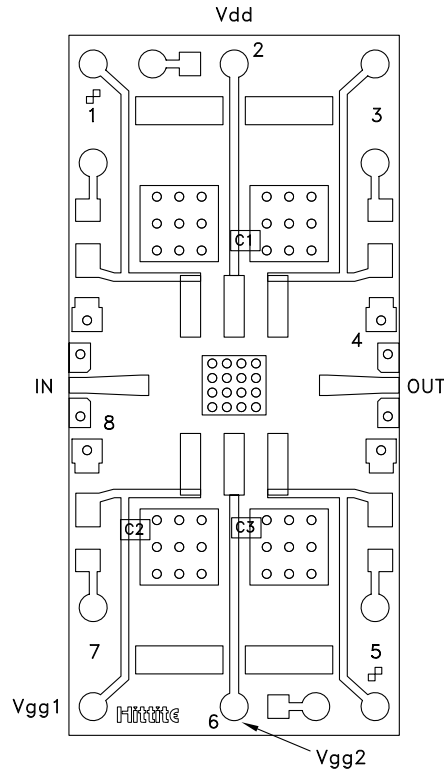

The grounded Co-Planar Wave Guide (CPWG) PCB input/output transitions allow use of Ground-Signal-Ground (GSG) probes for testing. Suggested probe pitch is 400um (16 mils). Alternatively, the board can be mounted in a metal housing with 2.4mm coaxial connectors.

Evaluation Circuit Board Layout Design Details

Layout Technique	Micro Strip to CPWG
Material	Rogers 4003 with 1/2 oz, Cu
Dielectric Thickness	0.008" (0.20 mm)
Microstrip Line Width	0.018" (0.46 mm)
CPWG Line Width	0.016" (0.41 mm)
CPWG Line to GND Gap	0.005" (0.13 mm)
Ground Via Hole Diameter	0.008" (0.20 mm)
C1 - C3	100 pF Capacitor, 0402 Pkg.

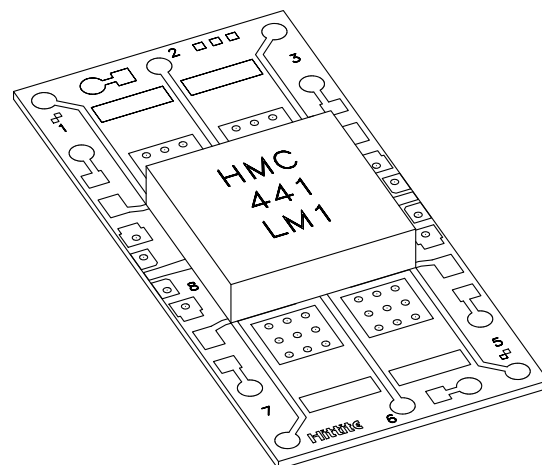

Suggested LM1 PCB Land Pattern Tolerance: $\pm 0.003"$ (± 0.08 mm)

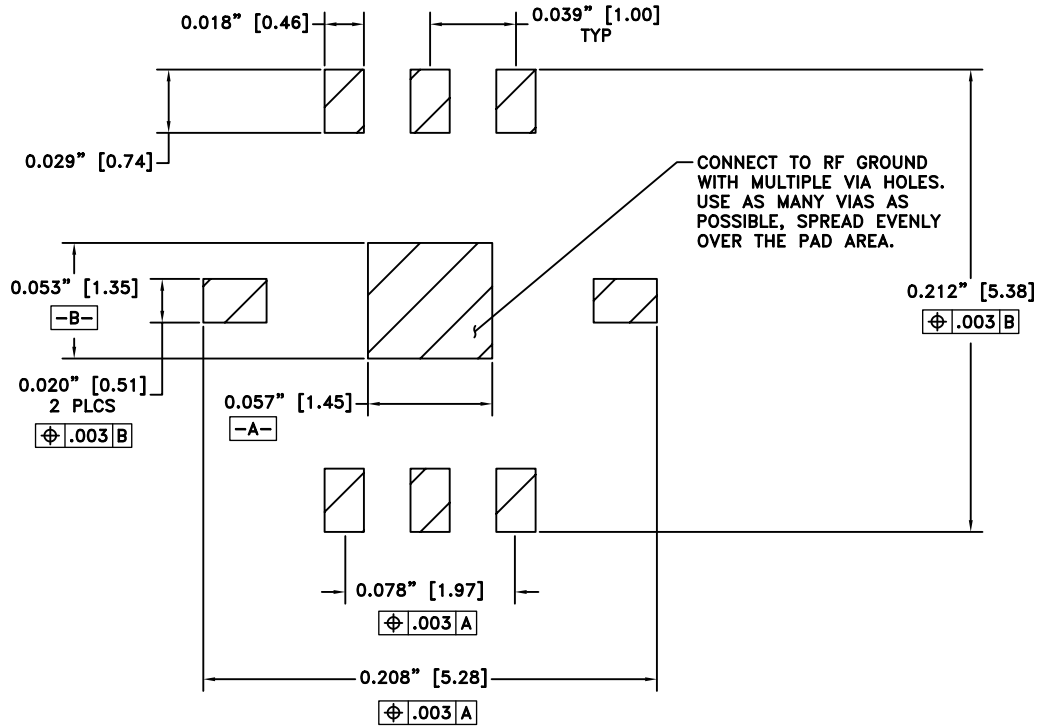

Amplifier Application Circuit

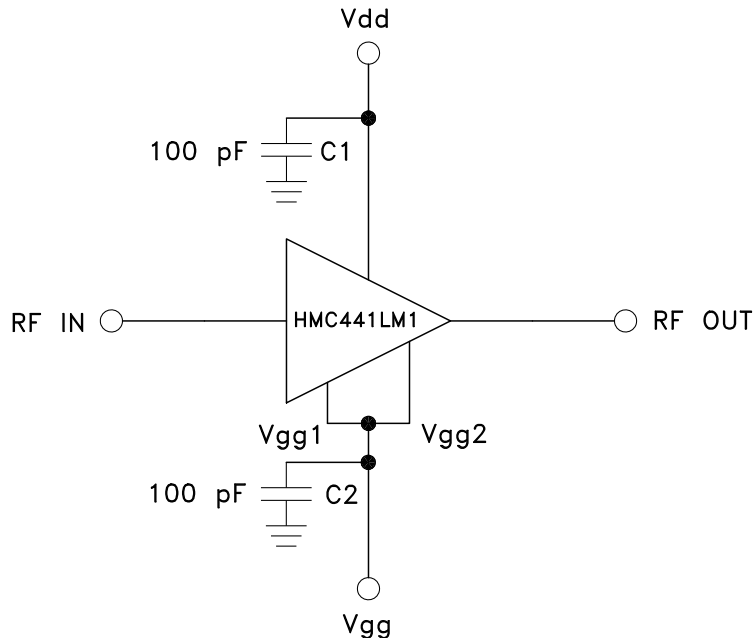

Note: Optional gate bias connections. Vgg1 and Vgg2 may be connected to a common Vgg feed.

Recommended SMT Attachment Technique

Preparation & Handling of the LM1 Microwave Package for Surface Mounting

The HMC LM1 package was designed to be compatible with high volume surface mount PCB assembly processes. The LM1 package requires a specific mounting pattern to allow proper mechanical attachment and to optimize electrical performance at millimeterwave frequencies. This PCB layout pattern can be found on each LM1 product data sheet. It can also be provided as an electronic drawing upon request from Hittite Sales & Application Engineering.

Follow these precautions to avoid permanent damage:

Cleanliness: Observe proper handling procedures to ensure clean devices and PCBs. LM1 devices should remain in their original packaging until component placement to ensure no contamination or damage to RF, DC & ground contact areas.

Static Sensitivity: Follow ESD precautions to protect against ESD strikes.

General Handling: Handle the LM1 package on the top with a vacuum collet or along the edges with a sharp pair of bent tweezers. Avoiding damaging the RF, DC, & ground contacts on the package bottom. Do not apply excess pressure to the top of the lid.

Solder Materials & Temperature Profile: Follow the information contained in the application note. Hand soldering is not recommended. Conductive epoxy attachment is not recommended.

Solder Paste: Solder paste should be selected based on the user's experience and be compatible with the metallization systems used. See the LM1 data sheet Outline drawing for pin & ground contact metallization schemes.

Solder Paste Application: Solder paste is generally applied to the PCB using either a stencil printer or dot placement. The volume of solder paste will be dependent on PCB and component layout and should be controlled to ensure consistent mechanical & electrical performance. Excess solder may create unwanted electrical parasitics at high frequencies.

Solder Reflow: The soldering process is usually accomplished in a reflow oven but may also use a vapor phase process. A solder reflow profile is suggested above.

Prior to reflowing product, temperature profiles should be measured using the same mass as the actual assemblies. The thermocouple should be moved to various positions on the board to account for edge and corner effects and varying component masses. The final profile should be determined by mounting the thermocouple to the PCB at the location of the device.

Follow solder paste and oven vendor's recommendations when developing a solder reflow profile. A standard profile will have a steady ramp up from room temperature to the pre-heat temperature to avoid damage due to thermal shock. Allow enough time between reaching pre-heat temperature and reflow for the solvent in the paste to evaporate and the flux to completely activate. Reflow must then occur prior to the flux being completely driven off. The duration of peak reflow temperature should not exceed 15 seconds. Packages have been qualified to withstand a peak temperature of 235°C for 15 seconds. Verify that the profile will not expose device to temperatures in excess of 235°C.

Cleaning: A water-based flux wash may be used.

