



## A5A:6100.XX

### VOLTAGE RATINGS

Part Number	$V_{RRM}, V_R - (V)$ Max. rep. peak reverse voltage		$V_{RSM}, V_R - (V)$ Max. non-rep. peak reverse voltage
	$T_J = 0$ to $200^\circ\text{C}$	$T_J = -40$ to $0^\circ\text{C}$	$T_J = 25$ to $200^\circ\text{C}$
	A5A:6100.02	200	200
A5A:6100.04	400	400	500
A5A:6100.06	600	600	700
A5A:6100.08	800	800	900
A5A:6100.10	1000	1000	1100
A5A:6100.12	1200	1200	1300

### MAXIMUM ALLOWABLE RATINGS

PARAMETER	VALUE	UNITS	NOTES
$T_J$ Junction Temperature	-40 to 200	$^\circ\text{C}$	-
$T_{stg}$ Storage Temperature	-40 to 200	$^\circ\text{C}$	-
$I_{F(AV)}$ Max. Av. current	6100	A	180° half sine wave
	@ Max. $T_C$	100	
$I_{F(RMS)}$ Nom. RMS current	9580	A	-
$I_{FSM}$ Max. Peak non-rep. surge current	63.8	kA	50 Hz half cycle sine wave Initial $T_J = 200^\circ\text{C}$ , rated $V_{RRM}$ applied after surge.
	69.5		60 Hz half cycle sine wave
	75.8		50 Hz half cycle sine wave Initial $T_J = 200^\circ\text{C}$ , no voltage applied after surge.
	82.6		60 Hz half cycle sine wave
$I^2t$ Max. $I^2t$ capability	18440	$\text{kA}^2\text{s}$	$t = 10\text{ms}$ Initial $T_J = 200^\circ\text{C}$ , rated $V_{RRM}$ applied after surge.
	20100		$t = 8.3\text{ms}$
	26055		$t = 10\text{ms}$ Initial $T_J = 200^\circ\text{C}$ , no voltage applied after surge.
	28400		$t = 8.3\text{ms}$
$I^2t^{1/2}$ Max. $I^2t^{1/2}$ capability	311000	$\text{kA}^2\text{s}^{1/2}$	Initial $T_J = 200^\circ\text{C}$ , no voltage applied after surge. for time $t_x = I^2t^{1/2} * t_x^{1/2}$ . ( $0.1 < t_x < 10\text{ms}$ ).
F Mounting Force	4550	N.m	-



# A5A:6100.XX

## CHARACTERISTICS

PARAMETER	MIN.	TYP.	MAX.	UNITS	TEST CONDITIONS
$V_{FM}$ peak on-state voltage	---	---	1.52	V	Initial $T_J = 25^\circ\text{C}$ , 50-60Hz half sine, $I_{beak} = 19154\text{A}$ .
$V_{F(TO)1}$ Low-level threshold	---	---	0.778	V	$T_J = 200^\circ\text{C}$ Av. power = $V_{T(TO)} * I_{T(AV)} + r_T * [I_{T(RMS)}]^2$ , 180 Half Sine.
$V_{F(TO)2}$ High-level threshold	---	---	0.923		
$r_{F1}$ Low-level resistance	---	---	0.044	m $\Omega$	Use low values for $I_{TM} < \pi$ rated $I_{T(AV)}$
$r_{F2}$ High-level resistance	---	---	0.064		
$I_{RRM}$ Peak reverse current	---	200	-	mA	$T_J = 200^\circ\text{C}$ , Rated $V_{RRM}$
$R_{thJC}$ Thermal resistance, junction-to-case	---	---	0.011	$^\circ\text{C/W}$	DC operation, double side cooled.
	---	---	0.012	$^\circ\text{C/W}$	180 $^\circ$ sine wave, double side cooled.
	---	---	0.012	$^\circ\text{C/W}$	120 $^\circ$ rectangular wave, double side cooled.
$R_{thCS}$ Thermal resistance, case-to-sink	---	---	0.006	$^\circ\text{C/W}$	Mtg. Surface smooth, flat and greased. Double side cooled.
wt Weight	---	1590(55.3)	---	g(oz.)	---
Case Style	---	TO-200AE		JEDEC	---

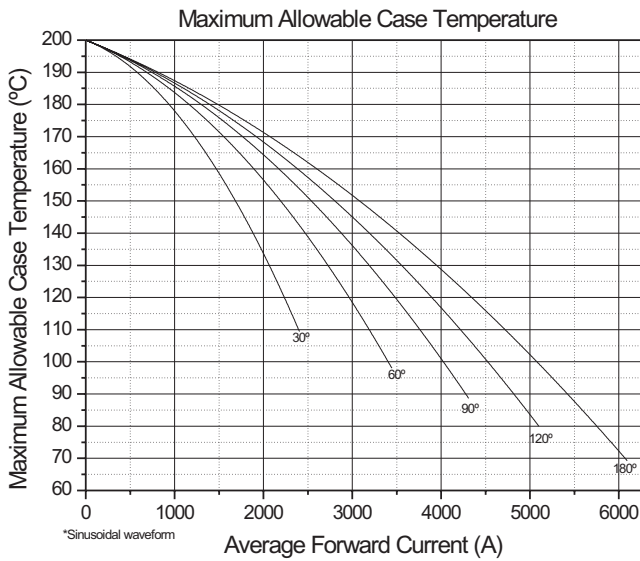

**Fig. 1 - Current Ratings Characteristics**

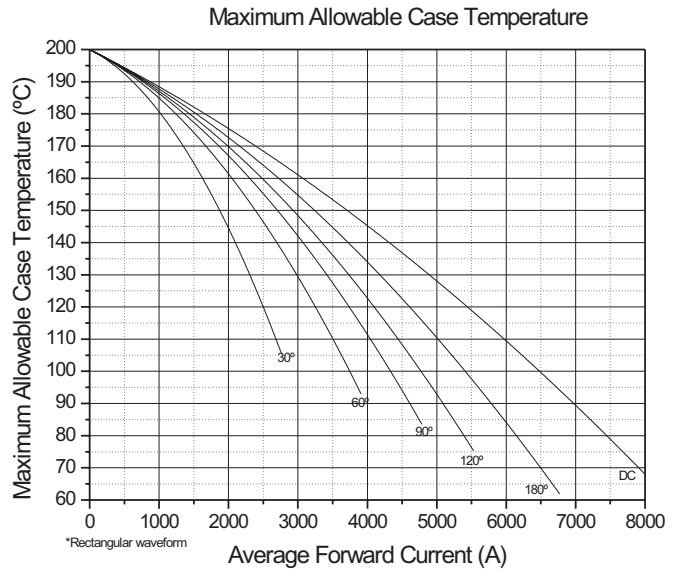

**Fig. 2 - Current Ratings Characteristics**



# A5A:6100.XX

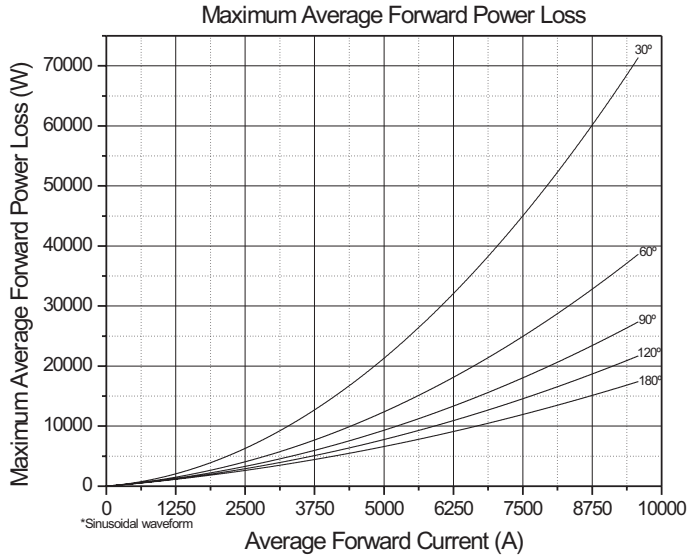

**Fig. 3 - Average Forward Power Loss Characteristics**

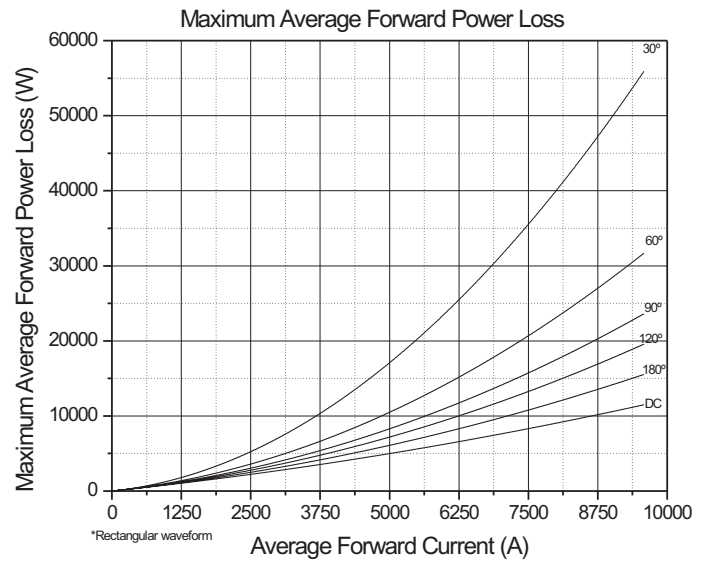

**Fig. 4 - Average Forward Power Loss Characteristics**

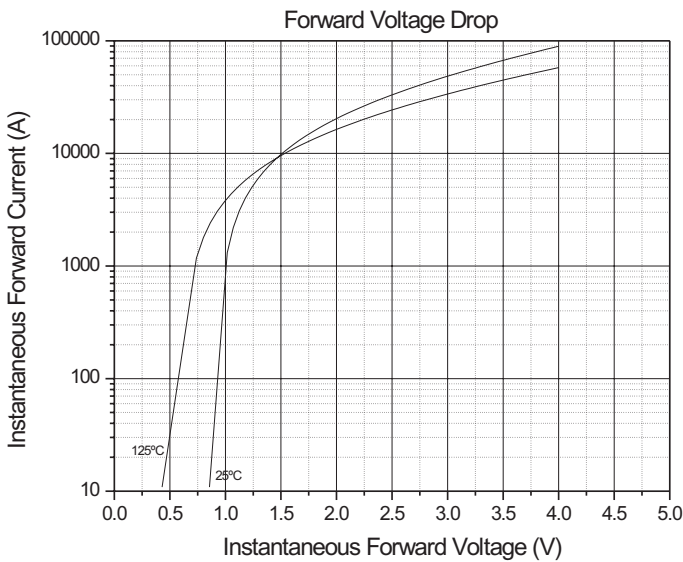

**Fig. 5 - Forward Voltage Drop Characteristics**

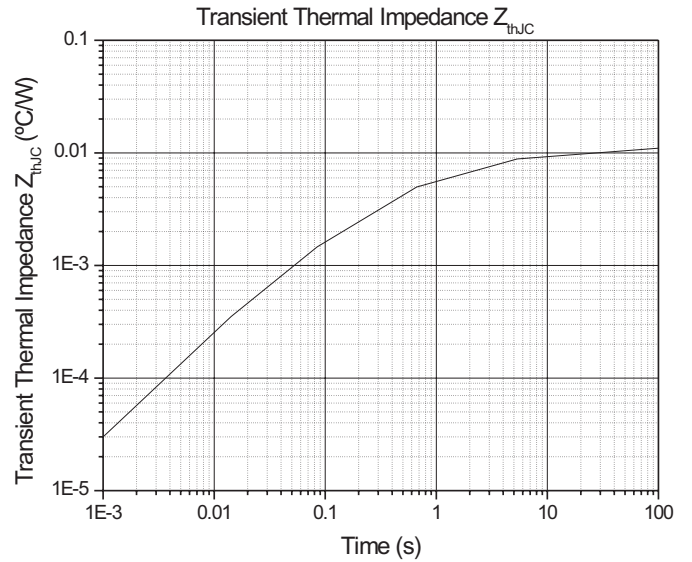
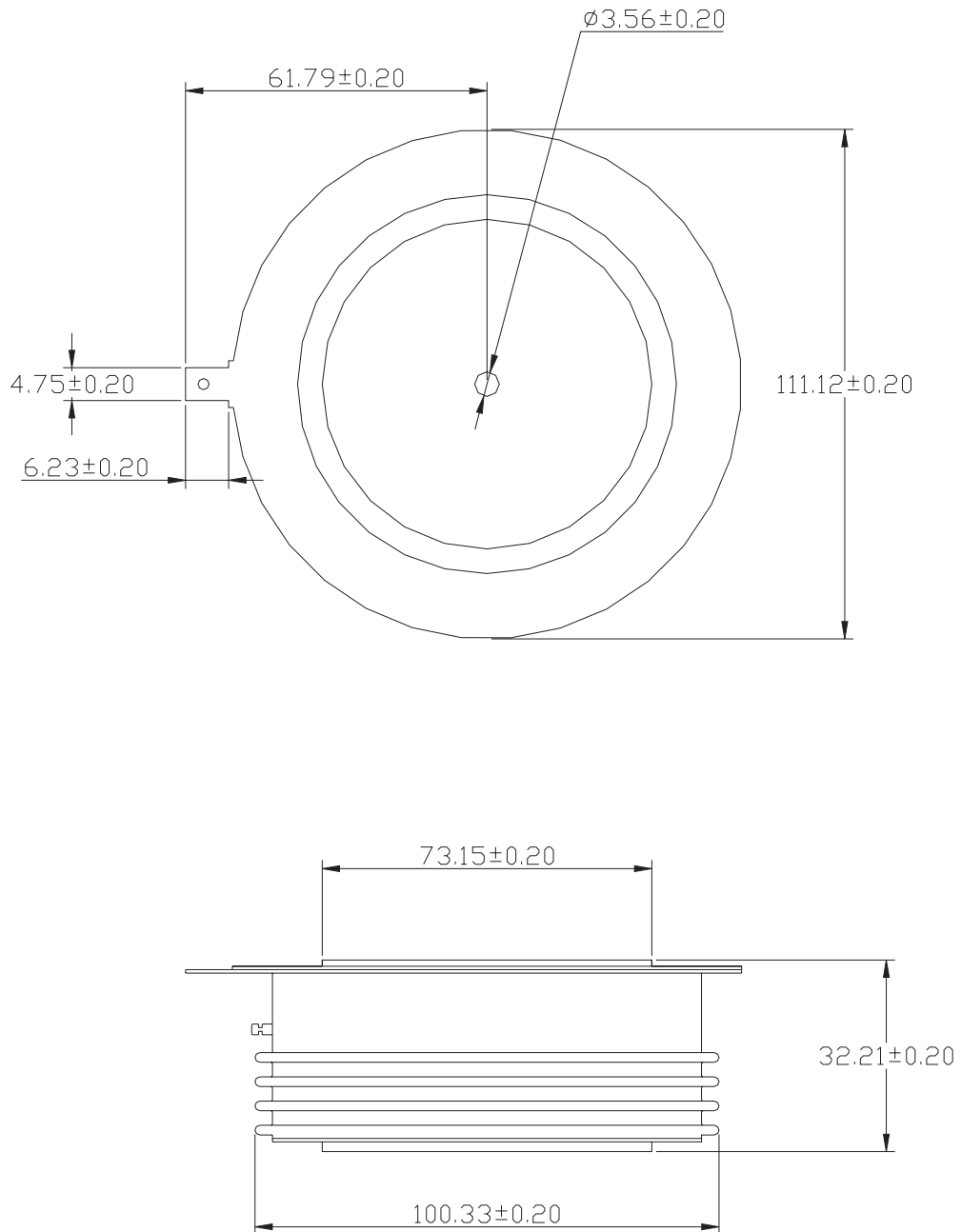

**Fig. 6 - Transient Thermal Impedance  $Z_{thJC}$  Characteristics**



## A5A:6100.XX

### TO-200AE



**Fig. 7 - Outline Characteristics**