

# SEMiX 202GB066HD

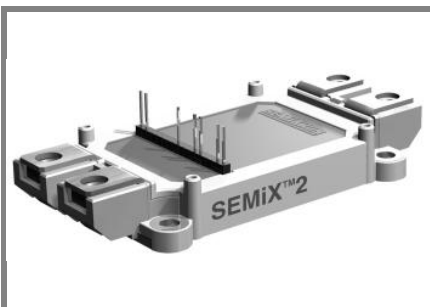

SEMiX® 2

## Trench IGBT Modules

### SEMiX 202GB066HD

#### Target Data

#### Features

- Homogeneous Si
- Trench = Trenchgate technology
- $V_{CE(sat)}$  with positive temperature coefficient

#### Typical Applications

- Matrix Converter
- Resonant Inverter
- Current Source Inverter

#### Remarks

- Case temperature limited to  $T_C=125^\circ\text{C}$  max.
- Product reliability results are valid for  $T_j=150^\circ\text{C}$
- SC data:  $t_p \leq 6 \mu\text{s}$ ;  $V_{GE} \leq 15 \text{ V}$ ;  $T_j = 150^\circ\text{C}$ ;  $V_{CC} = 360 \text{ V}$

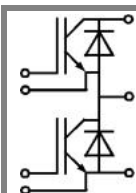

GB

Absolute Maximum Ratings		$T_{case} = 25^\circ\text{C}$ , unless otherwise specified	
Symbol	Conditions	Values	Units
<b>IGBT</b>			
$V_{CES}$		600	V
$I_C$	$T_c = 25 (80)^\circ\text{C}$ , $T_j = 150^\circ\text{C}$	240 (170)	A
$I_C$	$T_c = 25 (80)^\circ\text{C}$ , $T_j = 175^\circ\text{C}$	270 (200)	A
$I_{CRM}$	$t_p = 1 \text{ ms}$	400	A
$V_{GES}$		$\pm 20$	V
$T_j, (T_{stg})$		- 40 ... + 175 (125)	$^\circ\text{C}$
$V_{isol}$	AC, 1 min.	4000	V
<b>Inverse diode</b>			
$I_F$	$T_c = 25 (80)^\circ\text{C}$ , $T_j = 150^\circ\text{C}$	190 (130)	A
$I_F$	$T_c = 25 (80)^\circ\text{C}$ , $T_j = 175^\circ\text{C}$	210 (160)	A
$I_{FRM}$	$t_p = 1 \text{ ms}$	400	A
$I_{FSM}$	$t_p = 10 \text{ ms}$ ; sin.; $T_j = 25^\circ\text{C}$	1000	A

Characteristics		$T_{case} = 25^\circ\text{C}$ , unless otherwise specified			
Symbol	Conditions	min.	typ.	max.	Units
<b>IGBT</b>					
$V_{GE(th)}$	$V_{GE} = V_{CE}$ , $I_C = 6,4 \text{ mA}$		5,8		V
$I_{CES}$	$V_{CE} = 0$ , $V_{GE} = V_{CES}$ , $T_j = 25 ( )^\circ\text{C}$			0,1	mA
$V_{CE(TO)}$	$T_j = 25 (150)^\circ\text{C}$		0,9 (0,85)	1 (0,9)	V
$r_{CE}$	$V_{GE} = 15 \text{ V}$ , $T_j = 25 (150)^\circ\text{C}$		2,75 (4,25)	4,5 (6)	m $\Omega$
$V_{CE(sat)}$	$I_{Cnom} = 200 \text{ A}$ , $V_{GE} = 15 \text{ V}$ , $T_j = 25 (150)^\circ\text{C}$ , chip level		1,45 (1,7)	1,9 (2,1)	V
$C_{ies}$	under following conditions		12,1		nF
$C_{oes}$	$V_{GE} = 0$ , $V_{CE} = 25 \text{ V}$ , $f = 1 \text{ MHz}$		0,75		nF
$C_{res}$			0,35		nF
$L_{CE}$			18		nH
$R_{CC+EE}$	terminal-chip, $T_c = 25 (125)^\circ\text{C}$		0,7 (1)		m $\Omega$
$t_{d(on)}/t_r$	$V_{CC} = 300 \text{ V}$ , $I_{Cnom} = 200 \text{ A}$		66 / 78		ns
$t_{d(off)}/t_f$	$V_{GE} = -8/+15 \text{ V}$		545 / 95		ns
$E_{on} (E_{off})$	$R_{Gon} = R_{Goff} = 4,2 \Omega$ , $T_j = 150^\circ\text{C}$		6 (8)		mJ
<b>Inverse Diode</b>					
$V_F = V_{EC}$	$I_{Fnom} = 200 \text{ A}$ ; $V_{GE} = 0 \text{ V}$ ; $T_j = 25 (150)^\circ\text{C}$ , chip level		1,4 (1,4)	1,6	V
$V_{(TO)}$	$T_j = 25 (150)^\circ\text{C}$		1 (0,85)	1,1	V
$r_T$	$T_j = 25 (150)^\circ\text{C}$		2 (2,8)	2,6	m $\Omega$
$I_{RRM}$	$I_{Fnom} = 200 \text{ A}$ ; $T_j = 25 (150)^\circ\text{C}$		(203)		A
$Q_{rr}$	$di/dt = 3000 \text{ A}/\mu\text{s}$		(53)		$\mu\text{C}$
$E_{rr}$	$V_{GE} = -8 \text{ V}$		(32)		mJ
<b>Thermal characteristics</b>					
$R_{th(j-c)}$	per IGBT			0,22	K/W
$R_{th(j-c)D}$	per Inverse Diode			0,4	K/W
$R_{th(j-c)FD}$	per FWD				K/W
$R_{th(c-s)}$	per module		0,045		K/W
<b>Temperature sensor</b>					
$R_{25}$	$T_c = 25^\circ\text{C}$		5 $\pm$ 5%		k $\Omega$
$B_{25/85}$	$R_2 = R_1 \exp[B(1/T_2 - 1/T_1)]$ ; $T[K]; B$		3420		K
<b>Mechanical data</b>					
$M_s/M_t$	to heatsink (M5) / for terminals (M6)	3/2,5		5 / 5	Nm
w			250		g

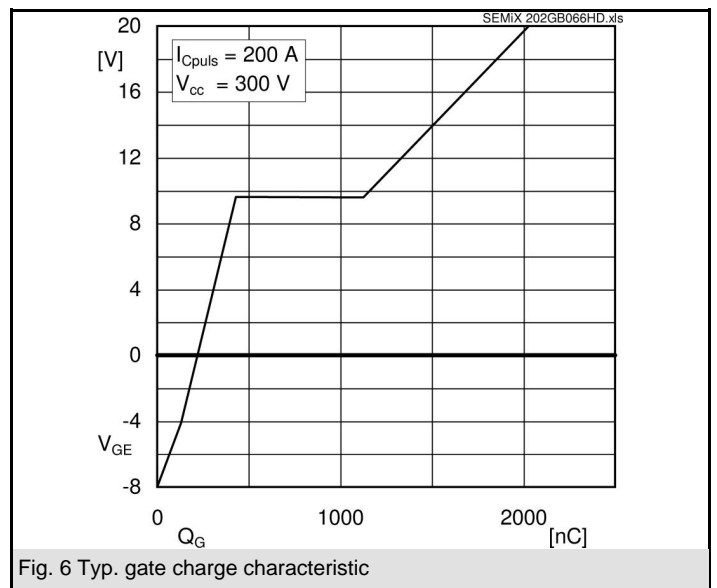
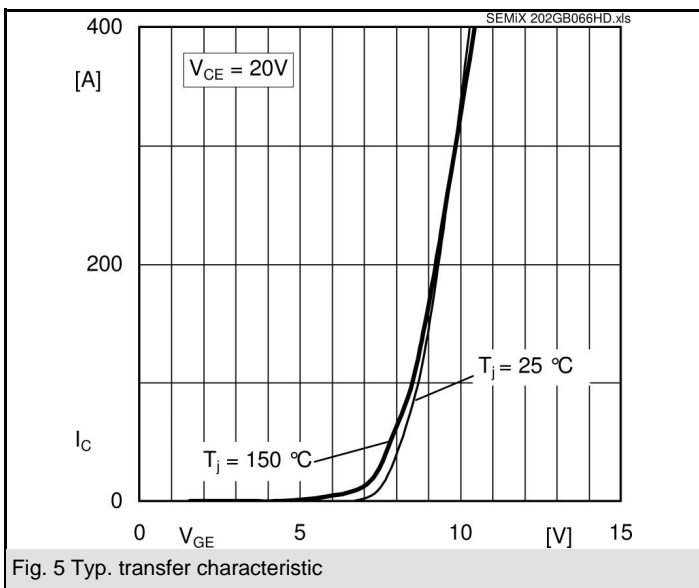
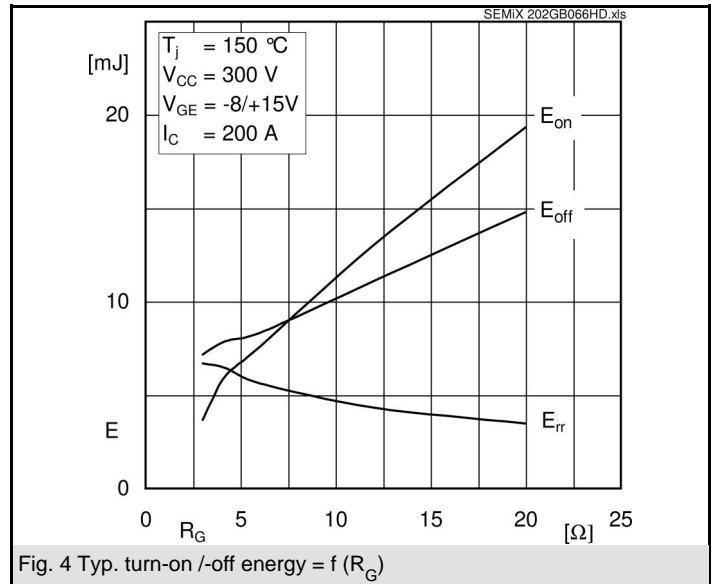
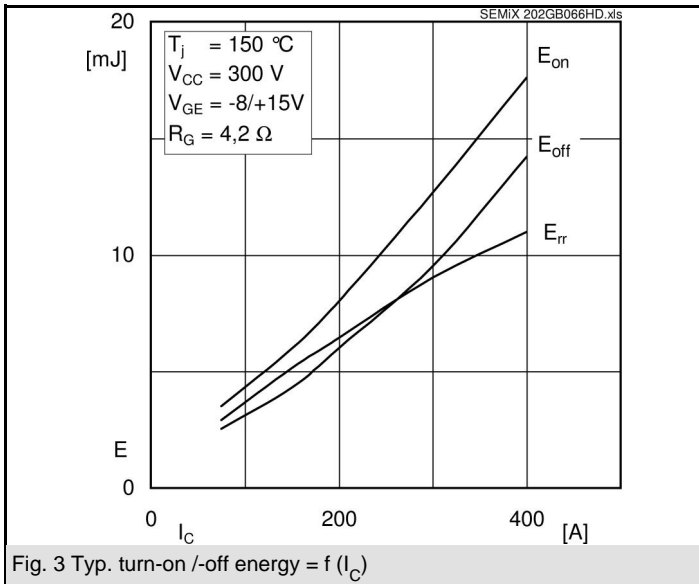
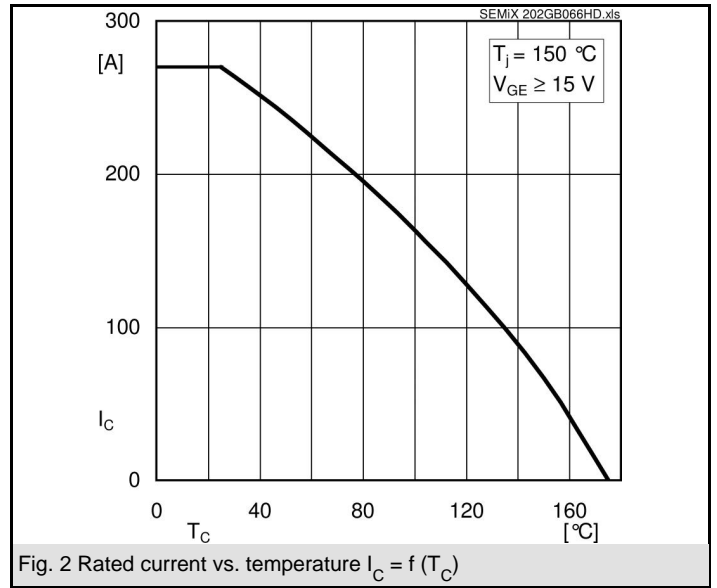
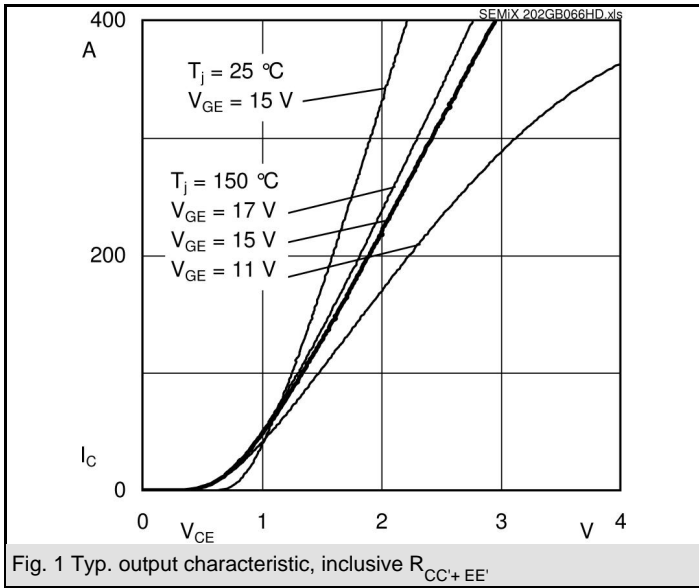

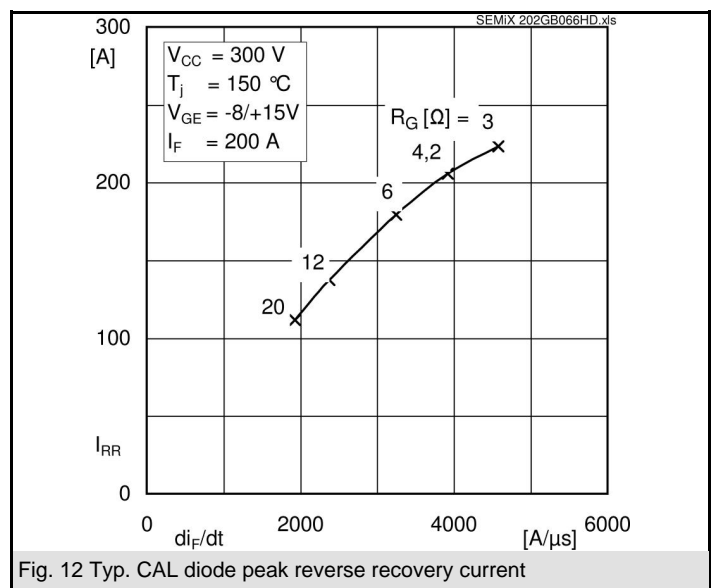
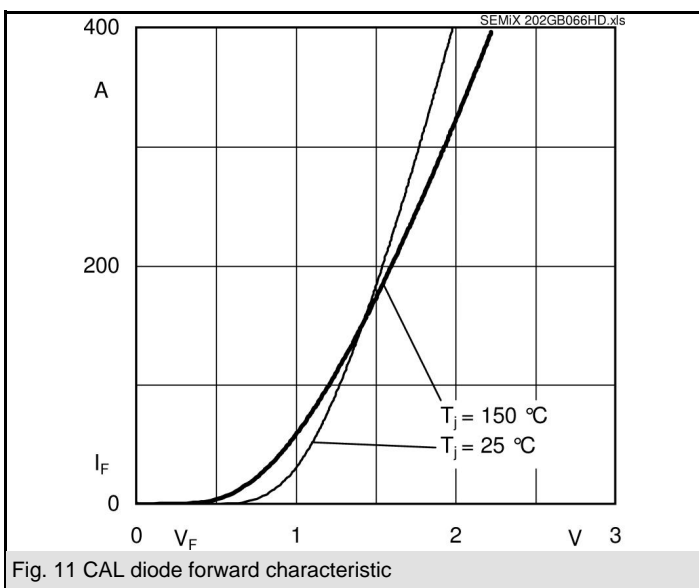
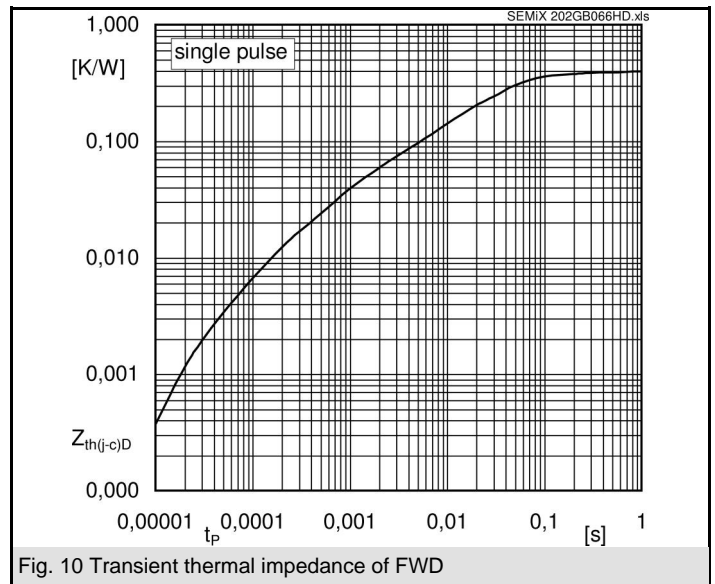
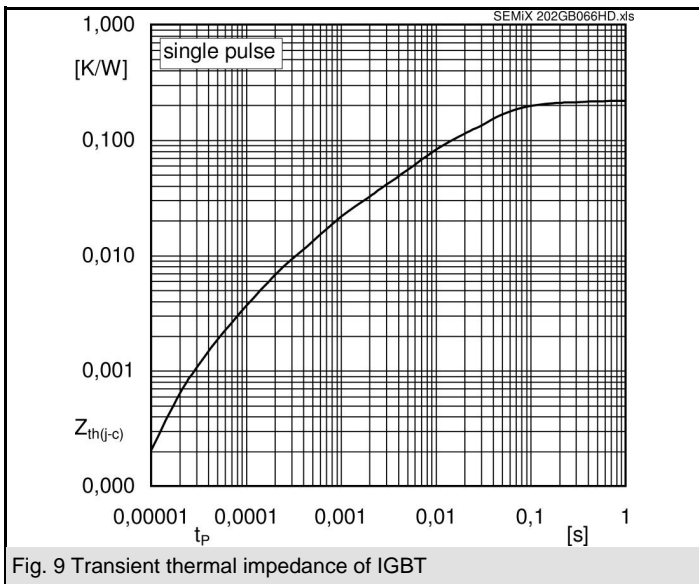
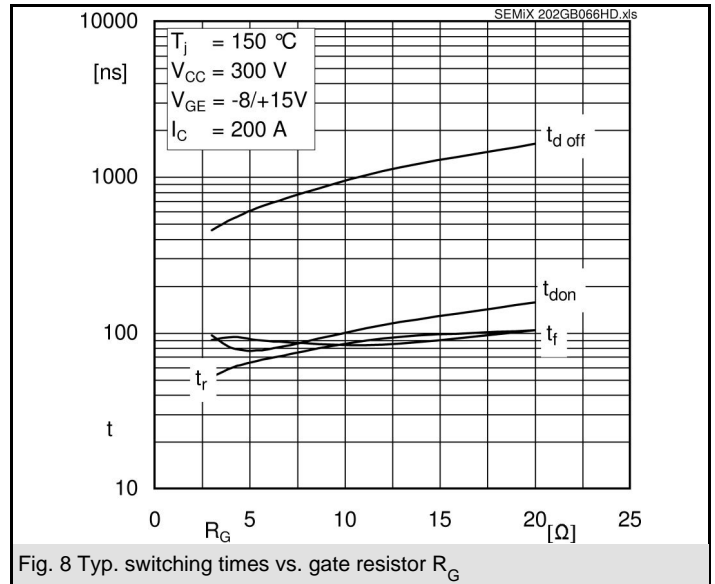
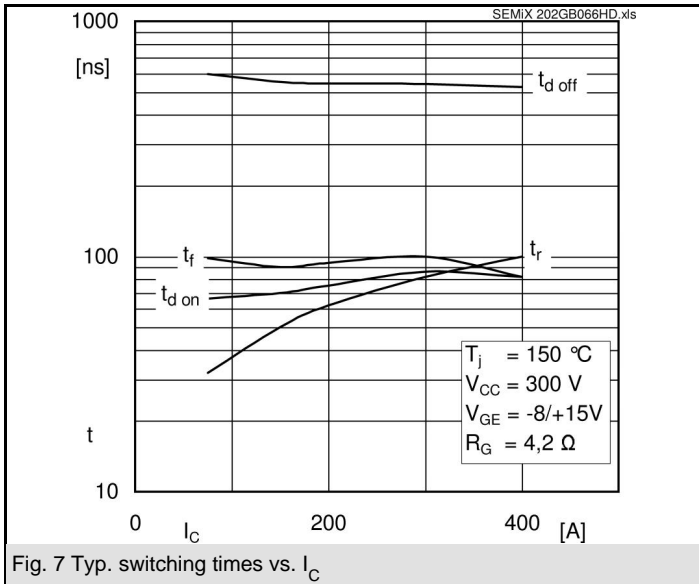

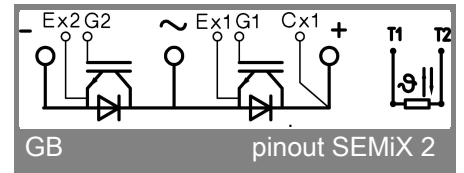
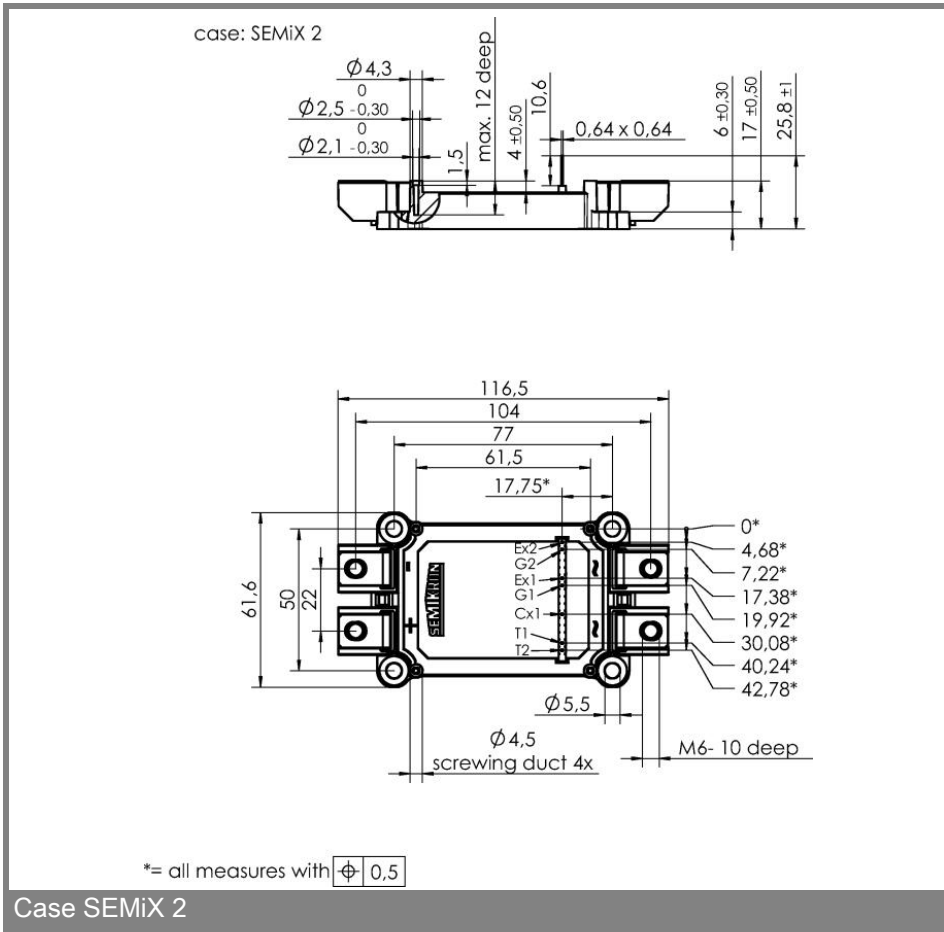
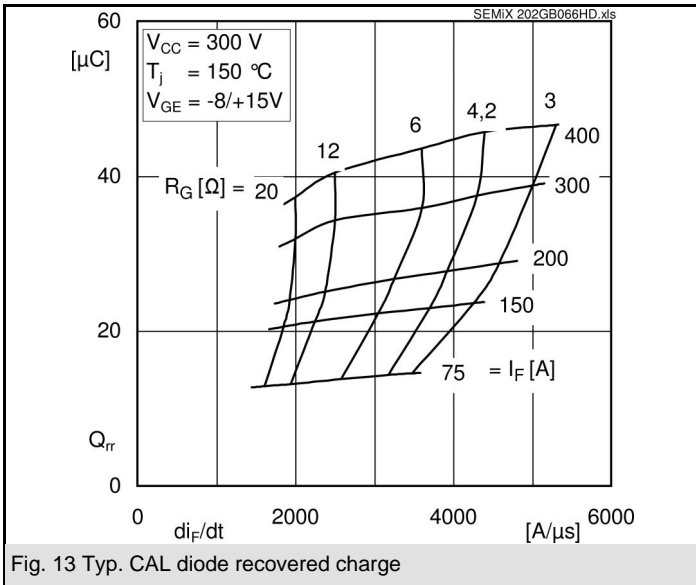

This is an electrostatic discharge sensitive device (ESDS), international standard IEC 60747-1, Chapter IX.

This technical information specifies semiconductor devices but promises no characteristics. No warranty or guarantee expressed or implied is made regarding delivery, performance or suitability.