





# SG117 / 217 / 317 / 117A / 217A / 317A

## 1.5A Three Terminal Adj. Voltage Regulator

### ABSOLUTE MAXIMUM RATINGS

Power Dissipation .....	Internally Limited
Input to Output Voltage Differential .....	40V
Storage Temperature Range .....	-65°C to 150°C
Operating Junction Temperature .....	150°C
Lead Temperature (Soldering 10 seconds).....	300°C

Note: Exceeding these ratings could cause damage to the device. All voltages are with respect to Ground. Currents are positive into, negative out of specified terminal.

### THERMAL DATA

#### **K** 3 Terminal TO-3 Metal Can

THERMAL RESISTANCE-JUNCTION TO CASE, $\theta_{JC}$	3.0°C/W
THERMAL RESISTANCE-JUNCTION TO AMBIENT, $\theta_{JA}$	35°C/W

#### **F** 10-Pin Flatpack

THERMAL RESISTANCE-JUNCTION TO CASE, $\theta_{JC}$	80°C/W
THERMAL RESISTANCE-JUNCTION TO AMBIENT, $\theta_{JA}$	145°C/W

#### **R** 3 Terminal TO-66 Metal Can

THERMAL RESISTANCE-JUNCTION TO CASE, $\theta_{JC}$	5.0°C/W
THERMAL RESISTANCE-JUNCTION TO AMBIENT, $\theta_{JA}$	40°C/W

#### **T** 3-Pin TO-39 Metal Can

THERMAL RESISTANCE-JUNCTION TO CASE, $\theta_{JC}$	15°C/W
THERMAL RESISTANCE-JUNCTION TO AMBIENT, $\theta_{JA}$	120°C/W

#### **G** 3-Pin TO-257 Hermetic

THERMAL RESISTANCE-JUNCTION TO CASE, $\theta_{JC}$	3.5°C/W
THERMAL RESISTANCE-JUNCTION TO AMBIENT, $\theta_{JA}$	42°C/W

#### **IG** 3-Pin TO-257 Hermetic (Isolated)

THERMAL RESISTANCE-JUNCTION TO CASE, $\theta_{JC}$	3.5°C/W
THERMAL RESISTANCE-JUNCTION TO AMBIENT, $\theta_{JA}$	42°C/W

#### **L** 20-Pin Ceramic (LCC) Leadless

THERMAL RESISTANCE-JUNCTION TO CASE, $\theta_{JC}$	35°C/W
THERMAL RESISTANCE-JUNCTION TO AMBIENT, $\theta_{JA}$	120°C/W

Junction Temperature Calculation:  $T_J = T_A + (P_D \times \theta_{JA})$ .

The  $\theta_{JA}$  numbers are guidelines for the thermal performance of the device/pc-board system. All of the above assume no ambient airflow.

**RECOMMENDED OPERATING CONDITIONS**

Parameter	SGx17x			Units
	Min	Typ	Max	
Input Voltage Range	$V_{OUT} + 3.5$		37	V
Operating Junction Temperature Range	SG117A / SG117	-55	150	°C
Operating Junction Temperature Range	SG217A / SG217	-25	150	°C
Operating Junction Temperature Range	SG317A / SG317	0	125	°C

Note 2: Range Over which the device is functional.

Note 3: These ratings are applicable for junction temperatures of less than 150°C

**ELECTRICAL CHARACTERISTICS**

Unless otherwise specified, these specifications apply over the full operating ambient temperature for the SG117A / SG117 with  $-55^{\circ}\text{C} \leq T_A \leq 125^{\circ}\text{C}$ , the SG217A / SG217 with  $-25^{\circ}\text{C} \leq T_A \leq 85^{\circ}\text{C}$ , and the SG317A / SG317 with  $0^{\circ}\text{C} \leq T_A \leq 70^{\circ}\text{C}$ ,  $V_{IN} - V_{OUT} = 5.0\text{V}$  and for  $I_{OUT} = 500\text{mA}$  (K,R, G, and IG) and  $I_{OUT} = 100\text{mA}$  (T, F, and L packages). Although power dissipation is internally limited, these specifications are applicable for power dissipations of 2W for the T and L packages, and 20W for the K, R, G, and IG packages.  $I_{MAX}$  is 1.5A for the K, R, G, and IG packages and 500m for the T, F, and L packages. Low duty cycle pulse testing techniques are used which maintains junction and case temperatures equal to the ambient temperature.

Parameter	Test Conditions	SG117A / SG217A			SG117 / SG217			Units
		Min	Typ	Max	Min	Typ	Max	
Reference Voltage	$I_{OUT} = 10\text{mA}$ , $T_A = 25^{\circ}\text{C}$ $3\text{V} \leq (V_{IN} - V_{OUT}) \leq 40\text{V}$ , $P \leq P_{MAX}$	1.238	1.250	1.262				V
Line Regulation (Note 4)	$10\text{mA} \leq I_{OUT} \leq I_{MAX}$ $3\text{V} \leq (V_{IN} - V_{OUT}) \leq 40\text{V}$ , $I_L = 10\text{mA}$ $T_A = 25^{\circ}\text{C}$	1.225	1.250	1.270	1.20	1.25	1.30	V
	$T_A = T_{MIN}$ to $T_{MAX}$		0.005	0.01		0.1	0.02	%/V
			0.01	0.02		0.02	0.05	%/V
Load Regulation (Note 4)	$10\text{mA} \leq I_{OUT} \leq I_{MAX}$ $V_{OUT} \leq 5\text{V}$ , $T_A = 25^{\circ}\text{C}$		5	15		5	15	mV
	$V_{OUT} > 5\text{V}$ , $T_A = 25^{\circ}\text{C}$		0.1	0.3		0.1	0.3	%
	$V_{OUT} \leq 5\text{V}$		20	50		20	50	mV
	$V_{OUT} \geq 5\text{V}$		0.3	1		0.3	1	%
Thermal Regulation (Note 5)	$T_A = 25^{\circ}\text{C}$ , 20ms pulse $V_{OUT} = 10\text{V}$ , $f = 120\text{Hz}$ $C_{ADJ} = 1\mu\text{F}$ , $T_A = 25^{\circ}\text{C}$		0.002	0.02		0.03	0.07	%/W
	$C_{ADJ} = 10\mu\text{F}$	66	65		66	65		dB
Adjust Pin Current			80			80		dB
Adjust Pin Current Change	$10\text{mA} < I_{OUT} < I_{MAX}$ , $2.5\text{V} < (V_{IN} - V_{OUT}) < 40\text{V}$		50	100		50	100	$\mu\text{A}$
Minimum Load Current	$(V_{IN} - V_{OUT}) = 40\text{V}$		3.5	5		3.5	5	mA
Current Limit	$(V_{IN} - V_{OUT}) \leq 15\text{V}$ K, P, R, G, IG Packages	1.5	2.2		1.5	2.2		A
	T, L Packages	0.5	0.8		0.5	0.8		A
	$(V_{IN} - V_{OUT}) = 40\text{V}$ , $T_J = 25^{\circ}\text{C}$ K, P, R, G, IG Packages	0.3	0.4		0.3	0.4		A
	T, L Packages	0.15	0.2		0.15	0.2		A
Temperature Stability (Note 5)			1	2		1		%
Long Term Stability (Note 5)	$T_A = 125^{\circ}\text{C}$ , 1000 Hours		0.3	1		0.3	1	%
RMS Output Noise (% of $V_{OUT}$ )	$T_A = 25^{\circ}\text{C}$ , $10\text{Hz} \leq f \leq 10\text{kHz}$ (Note 5)		0.001			0.001		%

**ELECTRICAL CHARACTERISTICS (CONTINUED)**

Unless otherwise specified, these specifications apply over the full operating ambient temperature for the SG117A / SG117 with  $-55^{\circ}\text{C} \leq T_A \leq 125^{\circ}\text{C}$ , the SG217A / SG217 with  $-25^{\circ}\text{C} \leq T_A \leq 85^{\circ}\text{C}$ , and the SG317A / SG317 with  $0^{\circ}\text{C} \leq T_A \leq 70^{\circ}\text{C}$ ,  $V_{\text{IN}} - V_{\text{OUT}} = 5.0\text{V}$  and for  $I_{\text{OUT}} = 500\text{mA}$  (K, R, G, and IG) and  $I_{\text{OUT}} = 100\text{mA}$  (T, F, and L packages). Although power dissipation is internally limited, these specifications are applicable for power dissipations of 2W for the T and L packages, and 20W for the K, R, G, and IG packages.  $I_{\text{MAX}}$  is 1.5A for the K, R, G, and IG packages and 500m for the T, F, and L packages. Low duty cycle pulse testing techniques are used which maintains junction and case temperatures equal to the ambient temperature.

Parameter	Test Conditions	SG317A			SG317			Units
		Min	Typ	Max	Min	Typ	Max	
Reference Voltage	$I_{\text{OUT}} = 10\text{mA}$ , $T_A = 25^{\circ}\text{C}$ $3\text{V} \leq (V_{\text{IN}} - V_{\text{OUT}}) \leq 40\text{V}$ , $P \leq P_{\text{MAX}}$	1.238	1.250	1.262				V
Line Regulation (Note 4)	$10\text{mA} \leq I_{\text{OUT}} \leq I_{\text{MAX}}$ $3\text{V} \leq (V_{\text{IN}} - V_{\text{OUT}}) \leq 40\text{V}$ , $I_L = 10\text{mA}$ $T_A = 25^{\circ}\text{C}$	1.225	1.250	1.270	1.20	1.25	1.30	V
	$T_A = T_{\text{MIN}}$ to $T_{\text{MAX}}$		0.005	0.01		0.1	0.04	%/V
Load Regulation (Note 4)	$10\text{mA} \leq I_{\text{OUT}} \leq I_{\text{MAX}}$ $V_{\text{OUT}} \leq 5\text{V}$ , $T_A = 25^{\circ}\text{C}$		5	25		5	25	mV
	$V_{\text{OUT}} > 5\text{V}$ , $T_A = 25^{\circ}\text{C}$		0.1	0.5		0.1	0.5	%
Thermal Regulation (Note 5)	$V_{\text{OUT}} \leq 5\text{V}$		20	50		20	70	mV
	$V_{\text{OUT}} \geq 5\text{V}$		0.3	1		0.3	1.5	%
Ripple Rejection	$T_A = 25^{\circ}\text{C}$ , 20ms pulse $V_{\text{OUT}} = 10\text{V}$ , $f = 120\text{Hz}$ $C_{\text{ADJ}} = 1\mu\text{F}$ , $T_A = 25^{\circ}\text{C}$		0.002	0.02		0.03	0.07	%/W
	$C_{\text{ADJ}} = 10\mu\text{F}$	66	80		66	80		dB
Adjust Pin Current	$T_A = 25^{\circ}\text{C}$		50	100		50	100	$\mu\text{A}$
Adjust Pin Current Change	$10\text{mA} < I_{\text{OUT}} < I_{\text{MAX}}$ , $2.5\text{V} < (V_{\text{IN}} - V_{\text{OUT}}) < 40\text{V}$		0.2	5		0.2	5	$\mu\text{A}$
Minimum Load Current	$(V_{\text{IN}} - V_{\text{OUT}}) = 40\text{V}$		3.5	5		3.5	5	mA
Current Limit	$(V_{\text{IN}} - V_{\text{OUT}}) \leq 15\text{V}$ K, P, R, G, IG Packages	1.5	2.2		1.5	2.2		A
	T, L Packages	0.5	0.8		0.5	0.8		A
Temperature Stability (Note 5)	$(V_{\text{IN}} - V_{\text{OUT}}) = 40\text{V}$ , $T_J = 25^{\circ}\text{C}$ K, P, R, G, IG Packages	0.3	0.4		0.3	0.4		A
	T, L Packages	0.15	0.2		0.15	0.2		A
Long Term Stability (Note 5)	$T_A = 125^{\circ}\text{C}$ , 1000 Hours		0.3	1		0.3	1	%
RMS Output Noise (% of $V_{\text{OUT}}$ )	$T_A = 25^{\circ}\text{C}$ , $10\text{Hz} \leq f \leq 10\text{kHz}$ (Note 5)		0.001			0.001		%

**NOTES**

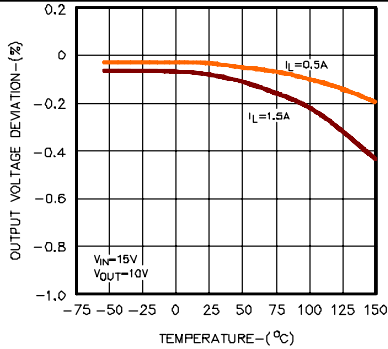
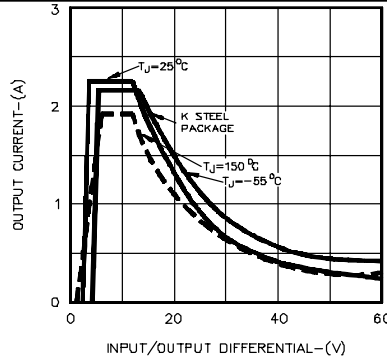
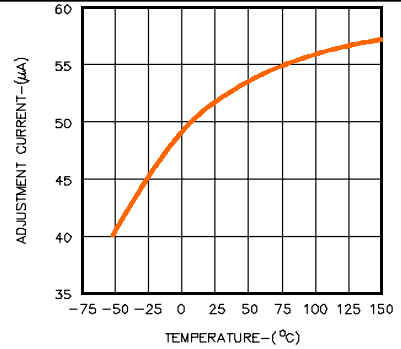
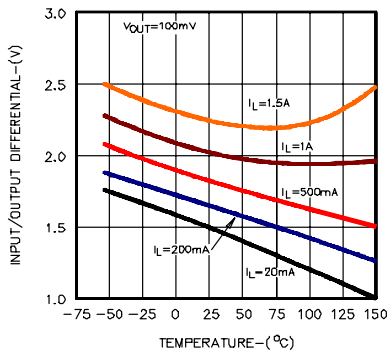
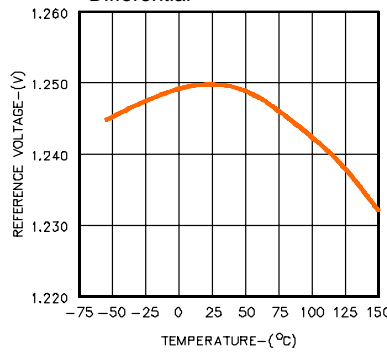
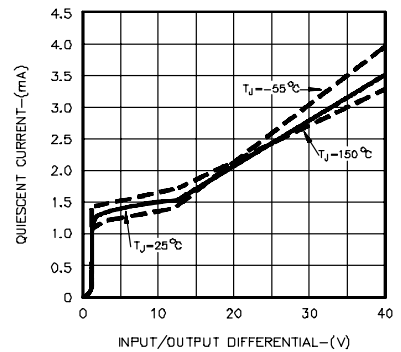
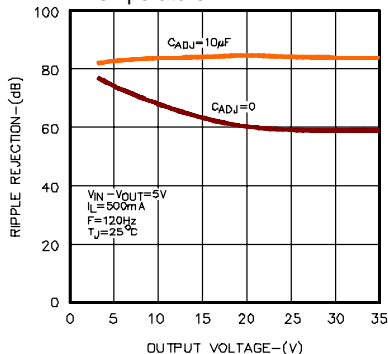
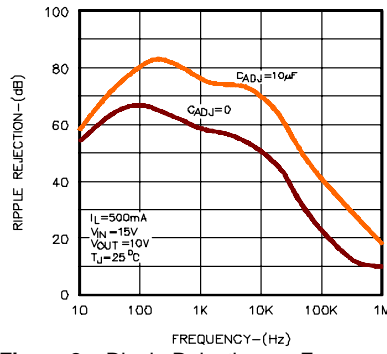
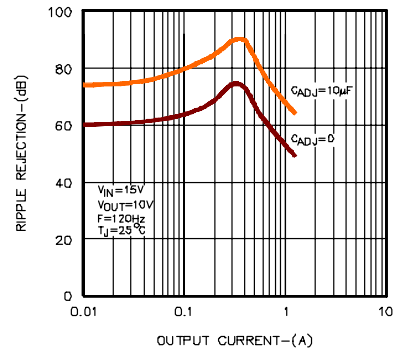
**CHARACTERISTIC CURVES**

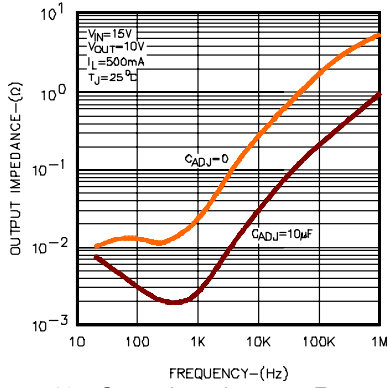
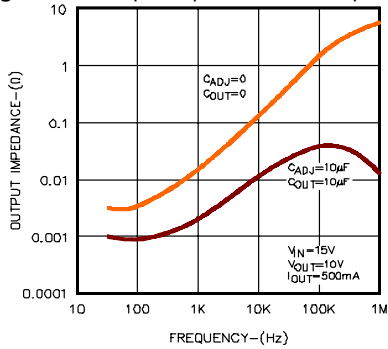
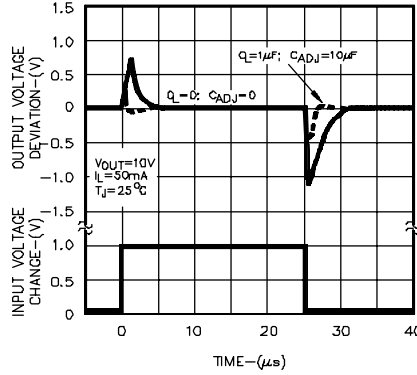
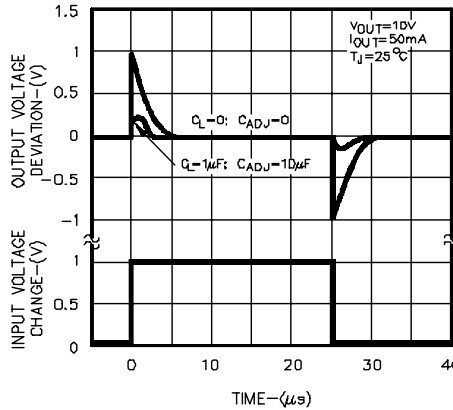
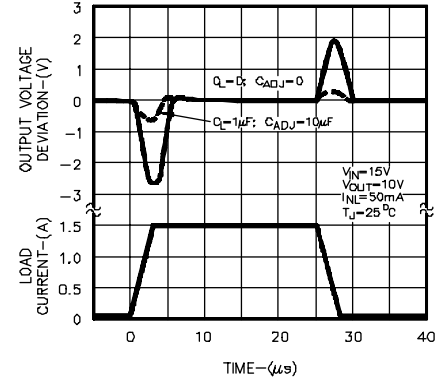
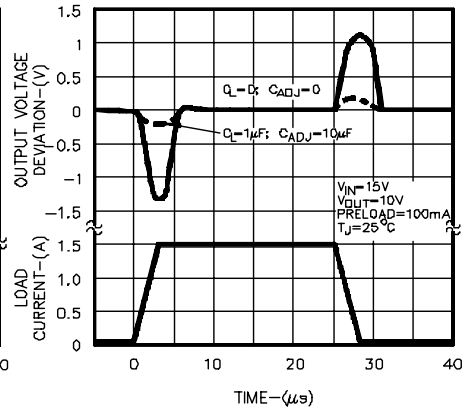
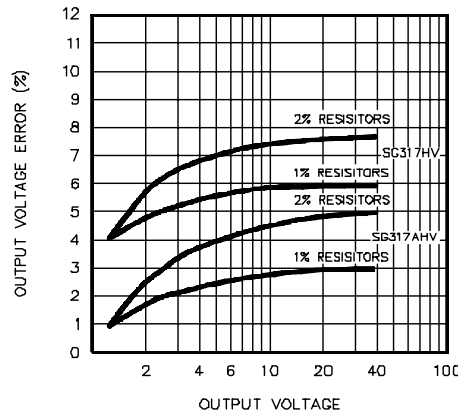
**Figure 1 – Output Voltage Deviation vs. Temperature**

**Figure 2 – Output Current vs. Input / Output Differential**

**Figure 3 – Adjustable Current vs. Temperature**

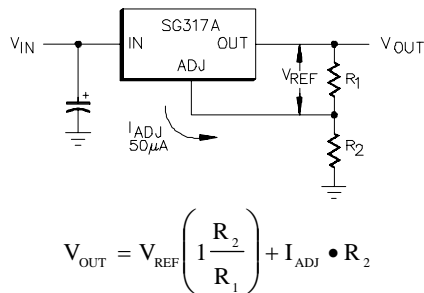
**Figure 4 – Input / Output Differential vs. Temperature**

**Figure 5 – Reference Voltage vs. Temperature**

**Figure 6 – Quiescent Current vs. Input / Output Differential**

**Figure 7 – Ripple Rejection vs. Output Voltage**

**Figure 8 – Ripple Rejection vs. Frequency**

**Figure 9 – Ripple Rejection vs. Output Current**

**CHARACTERISTIC CURVERS**

**Figure 10 – Output Impedance vs. Frequency**

**Figure 13 – Output Impedance vs. Frequency**

**Figure 11 – Line Transient Response**

**Figure 14 – Line Transient Response**

**Figure 12 – Load Transient Response**

**Figure 15 – Load Transient Response**

**Figure 16 – Output Voltage Error**

**APPLICATION INFORMATION**
**GENERAL**

The SG117A develops a 1.25V reference voltage between the output and the adjustable terminal (see Figure 1). By placing a resistor,  $R_1$  between these two terminals, a constant current is caused to flow through  $R_1$  and down through  $R_2$  to set the overall output voltage. Normally this current is the specified minimum load current of 5mA or 10mA.

**Figure 17 – Basic Regulator Circuit**

Because  $I_{ADJ}$  is very small and constant when compared with the current through  $R_1$ , it represents a small error and can usually be ignored.

It is easily seen from the above equation, that even if the resistors were of exact value, the accuracy of the output is limited by the accuracy of  $V_{REF}$ . Earlier adjustable regulators had a reference tolerance of  $\pm 4\%$ . This tolerance is dangerously close to the  $\pm 5\%$  supply tolerance required in many logic and analog systems. Further, many 1% resistors can drift 0.01%  $^{\circ}\text{C}$  adding another 1% to the output voltage tolerance.

For example, using 2% resistors and  $\pm 4\%$  tolerance for  $V_{REF}$ , calculations will show that the expected range of a 5V regulator design would be  $4.66\text{V} \leq V_{OUT} \leq 5.36\text{V}$  or approximately  $\pm 7\%$ . If the same example were used for a 15V regulator, the expected tolerance would be  $\pm 8\%$ . With these results most applications require some method of trimming, usually a trim pot. This solution is expensive and not conducive to volume production.

One of the enhancements of Silicon General's adjustable regulators over existing devices is tightened initial tolerance. This allows relatively inexpensive 1% or 2% film resistors to be used for  $R_1$  and  $R_2$  while setting output voltage within an acceptable tolerance range.

With a guaranteed 1% reference, a 5V power supply design, using  $\pm 2\%$  resistors, would have a worst case manufacturing tolerance of  $\pm 4\%$ . If 1% resistors were used, the tolerance would drop to  $\pm 2.5\%$ . A plot of the worst case output voltage tolerance as a function of resistor tolerance is shown on the front page.

For convenience, a table of standard 1% resistor values is shown below

**Table of ½% and 1% Standard Resistance Values**

1.00	1.47	2.15	3.16	4.64	6.81
1.02	1.50	2.21	3.24	4.75	6.98
1.05	1.54	2.26	3.32	4.87	7.15
1.07	1.58	2.32	3.40	4.99	7.32
1.10	1.62	2.37	3.48	5.11	7.50
1.13	1.65	2.43	3.57	5.23	7.68
1.15	1.69	2.49	3.65	5.36	7.87
1.18	1.74	2.55	3.74	5.49	8.06
1.21	1.78	2.61	3.83	5.62	8.25
1.24	1.82	2.67	3.92	5.76	8.45
1.27	1.87	2.74	4.02	5.90	8.66
1.30	1.91	2.80	4.12	6.04	8.87
1.33	1.96	2.87	4.22	6.19	9.09
1.37	2.00	2.94	4.32	6.34	9.31
1.40	2.05	3.01	4.42	6.49	9.53
1.43	2.10	3.09	4.53	6.65	9.76

Standard Resistance Values are obtained from the Decade Table by multiplying by multiples of 10. As an example: 1.21 can represent 1.21Ω, 12.1Ω, 121Ω, 1.21kΩ, etc.

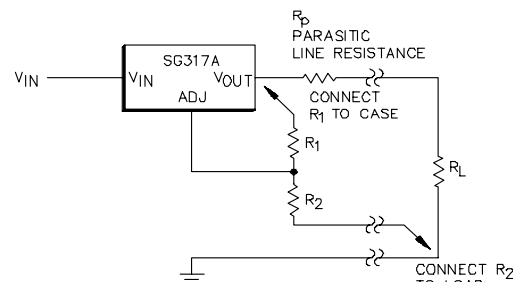
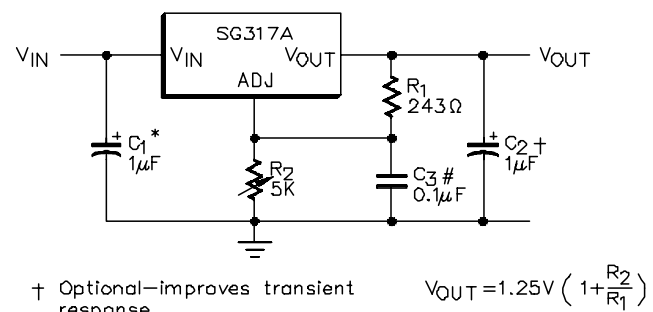
**Figure 18 – Connections for Best Load Regulation**

† Optional—improves transient response

\* Needed if device is far from filter capacitors

# Needed if load current is mechanically switched

**Figure 19 – 1.2V – 25V Adjustable Regulator**

**APPLICATION INFORMATION (CONTINUED)**
**BYPASS CAPACITORS**

Input bypassing using a 1µF tantalum or 25µF electrolytic is recommended when the input filter capacitors are more than 5 inches from the device. A 0.1µF bypass capacitor on the ADJUST pin is required if the load current varies by more than 1A/µsec. Improved ripple rejection (80dB) can be accomplished by adding a 10µF capacitor from the adjust pin to ground. For improved AC transient response and to prevent the possibility of oscillation due to unknown reactive load, a 1µF capacitor is also recommended at the output. Because of their low impedance at high frequencies, the best type of capacitor to use is solid tantalum.

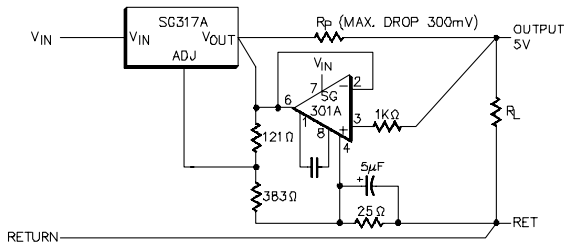
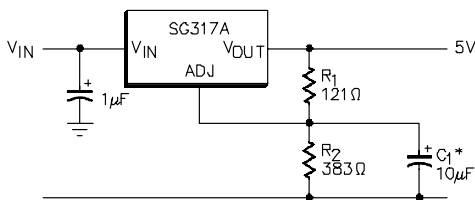
**Figure 20 – Remote Sensing**

\*C<sub>1</sub> Improves Ripple Rejection. X<sub>C</sub> should be small compared to R<sub>2</sub>.

**Figure 21 – Improving Ripple Rejection**
**LOAD REGULATION**

Because the SG117A is a three-terminal device, it is not possible to provide true remote load sensing. Load regulation will be limited by the resistance of the wire connecting the regulator to the load. For the data sheet specification, regulation is measured at the bottom of the package. Negative side sensing is a true Kelvin connection, with the bottom of the output divider returned to the negative side of the load. Although it may not be immediately obvious, best load regulation is obtained when the top of the divider is connected directly to the case, not to the load. This is illustrated in Figure 18. If R<sub>1</sub> were connected to the load, the effective resistance between the regulator and the load would be

$$R_p \cdot \left( \frac{R_2 + R_1}{R_1} \right), R_p = \text{Parasitic Line Resistance}$$

Connected as shown, R<sub>p</sub> is not multiplied by the divider ratio. R<sub>p</sub> is about 0.004Ω per foot using 16 gauge wire. This translates to 4mV/ft. at 1A load current, so it is important to keep the positive lead between regulator and load as short as possible.

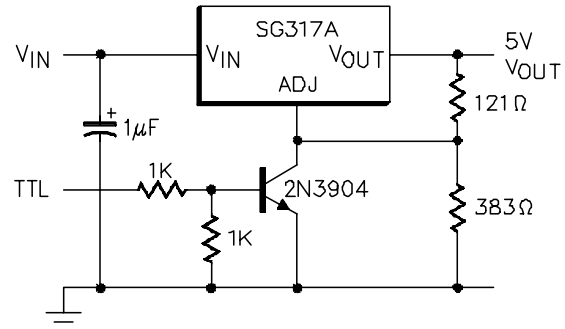
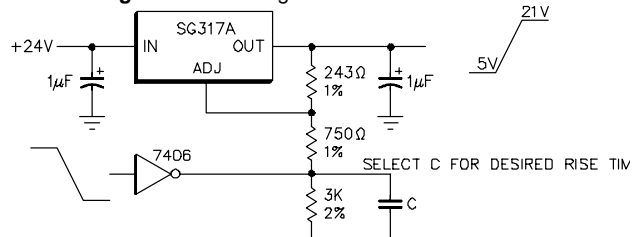
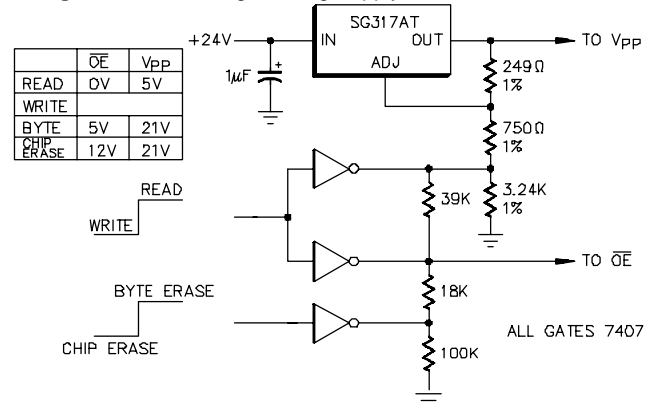
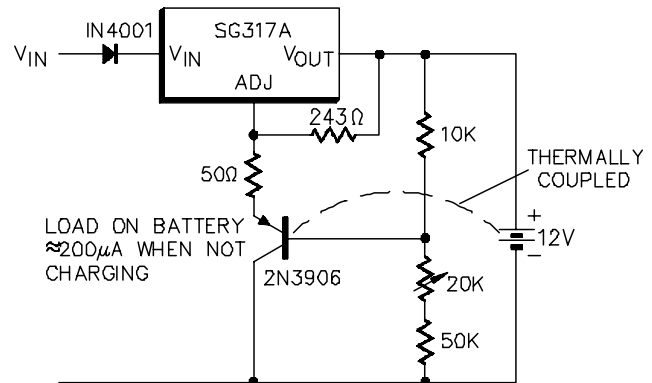
**Figure 22 – 5V Regulator with Shut Down**

**Figure 23 – 21V Programming Supply for UV Prom/EEPROM**

**Figure 24 – 2816 EEPROM Supply Programmer for Read / Write Control**

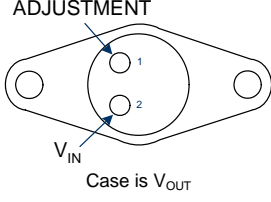
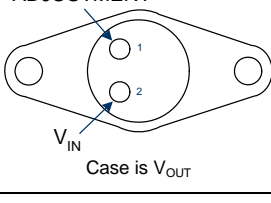
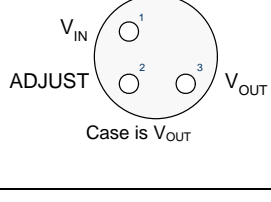
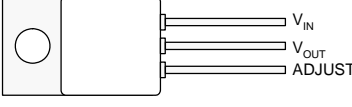
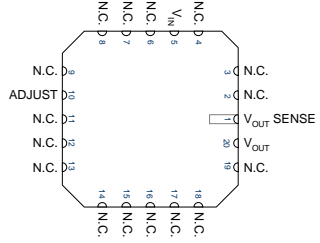
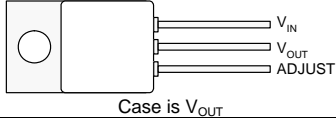
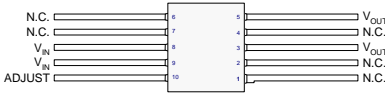
**Figure 25 – Temperature Compensated Lead Acid Battery Charger**



**CONNECTION DIAGRAMS & ORDERING INFORMATION (SEE NOTES BELOW)**

Package	Part No.	Ambient Temperature Range	Connection Diagram
3-Terminal TO-3 Metal Can K – Package	SG117AK/883B	-55°C to 125°C	
	SG117AK/DESC	-55°C to 125°C	
	SG117AK	-55°C to 125°C	
	SG217AK	-25°C to 85°C	
	SG317AK	0°C to 70°C	
	SG117K/883B	-55°C to 125°C	
	JAN117K	-55°C to 125°C	
	SG117K/DESC	-55°C to 125°C	
	SG117K	-55°C to 125°C	
	SG217K	-25°C to 85°C	
	SG317K	0°C to 70°C	
3-Pin TO-66 Metal Can R – Package	SG117AR/883B	-55°C to 125°C	
	SG117AR/DESC	-55°C to 125°C	
	SG117AR	-55°C to 125°C	
	SG217AR	-25°C to 85°C	
	SG317AR	0°C to 70°C	
	SG117R/883B	-55°C to 125°C	
	SG117AR/DESC	-55°C to 125°C	
	SG117R	-55°C to 125°C	
	SG217R	-25°C to 85°C	
	SG317R	0°C to 70°C	
3-Pin TO-39 Metal Can T – Package	SG117AT/883B	-55°C to 125°C	
	SG117AT/DESC	-55°C to 125°C	
	SG117AT	-55°C to 125°C	
	SG217AT	-25°C to 85°C	
	SG317AT	0°C to 70°C	
	SG117T/883B	-55°C to 125°C	
	JAN117T	-55°C to 125°C	
	SG117T/DESC	-55°C to 125°C	
	SG117T	-55°C to 125°C	
	SG217T	-25°C to 85°C	
	SG317T	0°C to 70°C	
3-Pin Hermetic TO-257 IG – Package (Isolated)	SG117AIG/883B	-55°C to 125°C	
	SG117AIG/DESC	-55°C to 125°C	
	SG117AIG	-55°C to 125°C	
	SG117IG/883B	-55°C to 125°C	
	SG117IG/DESC	-55°C to 125°C	
	SG117IG	-55°C to 125°C	
20-Pin Ceramic (LCC) Leadless Chip Carrier L – Package	SG117AL/883B	-55°C to 125°C	
	SG117AL/DESC	-55°C to 125°C	
	SG117AL	-55°C to 125°C	
	SG117L/883B	-55°C to 125°C	
	SG117L/DESC	-55°C to 125°C	
	SG117L	-55°C to 125°C	
3-Pin Hermetic TO-257 G – Package (Case is V <sub>OUT</sub> )	SG117AG/883B	-55°C to 125°C	
	SG117AG/DESC	-55°C to 125°C	
	SG117AG	-55°C to 125°C	
	SG117G/883B	-55°C to 125°C	
	SG117G	-55°C to 125°C	
10-Pin Flatpack F – Package	SG117AF	-55°C to 125°C	
	SG117AF/883B	-55°C to 125°C	
	SG117F	-55°C to 125°C	
	SG117F/883B	-55°C to 125°C	

Note

- 1: Contact factory for JAN and DESC product availability.
- 2: All parts are viewed from the top.
- 3: Both inputs and outputs must be externally connected together at the device terminals.
- 4: For normal operation, the SENSE pin must be externally connected to the load.