

# STD/SDT253

## Thyristor-Diode Modules, Diode-Thyristor Modules

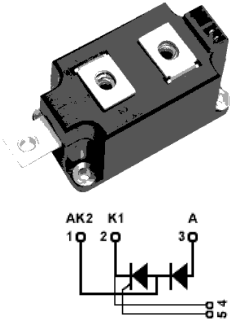

Type	$V_{RSM}$	$V_{RRM}$
	$V_{DSM}$	$V_{DRM}$
	V	V
STD/SDT253GK08	900	800
STD/SDT253GK12	1300	1200
STD/SDT253GK14	1500	1400
STD/SDT253GK16	1700	1600
STD/SDT253GK18	1900	1800

Dimensions in mm (1mm=0.0394")

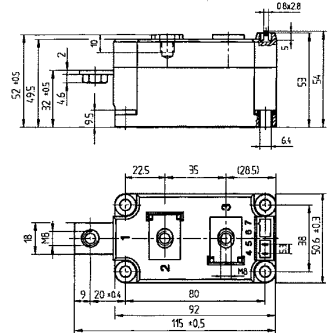

Symbol	Test Conditions	Maximum Ratings	Unit	
$I_{TRMS}, I_{FRMS}$ $I_{TAVM}, I_{FAVM}$	$T_{VJ}=T_{VJM}$ $T_C=85^{\circ}C; 180^{\circ}$ sine	400 253	A	
$I_{TSM}, I_{FSM}$	$T_{VJ}=45^{\circ}C$ $V_R=0$ $t=10ms$ (50Hz), sine $t=8.3ms$ (60Hz), sine	8500 9000	A	
	$T_{VJ}=T_{VJM}$ $V_R=0$ $t=10ms$ (50Hz), sine $t=8.3ms$ (60Hz), sine	7000 8000		
$\int i^2 dt$	$T_{VJ}=45^{\circ}C$ $V_R=0$ $t=10ms$ (50Hz), sine $t=8.3ms$ (60Hz), sine	405000 336000	A <sup>2</sup> s	
	$T_{VJ}=T_{VJM}$ $V_R=0$ $t=10ms$ (50Hz), sine $t=8.3ms$ (60Hz), sine	320000 240000		
$(di/dt)_{cr}$	$T_{VJ}=T_{VJM}$ $f=50Hz, t_p=200\mu s$ $V_D=2/3V_{DRM}$ $I_G=1A$ $di_G/dt=1A/\mu s$	repetitive, $I_T=750A$  non repetitive, $I_T=250A$	250 800	A/ $\mu s$
	$T_{VJ}=T_{VJM};$ $R_{GK}=\infty;$ method 1 (linear voltage rise)	$V_{DR}=2/3V_{DRM}$	1000	V/ $\mu s$
$P_{GM}$	$T_{VJ}=T_{VJM}$ $I_T=I_{TAVM}$	$t_p=30\mu s$ $t_p=500\mu s$	120 60	W
$P_{GAV}$			20	W
$V_{RGM}$			10	V
$T_{VJ}$ $T_{VJM}$ $T_{stg}$			-40...+140 140 -40...+130	$^{\circ}C$
$V_{ISOL}$	50/60Hz, RMS $I_{ISOL} \leq 1mA$	$t=1min$ $t=1s$	3000 3600	V~
$M_d$	Mounting torque (M5) Terminal connection torque (M8)		2.5-5/22-44 12-15/106-132	Nm/lb.in.
Weight	Typical including screws		430	g

# STD/SDT253

## Thyristor-Diode Modules, Diode-Thyristor Modules

Symbol	Test Conditions	Characteristic Values	Unit
<b>I<sub>RRM</sub></b>	$T_{VJ}=T_{VJM}; V_R=V_{RRM}; V_D=V_{DRM}$	70	mA
<b>I<sub>DRM</sub></b>		40	mA
<b>V<sub>T</sub>, V<sub>F</sub></b>	$I_T, I_F=750A; T_{VJ}=25^{\circ}C$	1.7	V
<b>V<sub>TO</sub></b>	For power-loss calculations only ( $T_{VJ}=140^{\circ}C$ )	0.85	V
<b>r<sub>T</sub></b>		1.1	m $\Omega$
<b>V<sub>GT</sub></b>	$V_D=6V; T_{VJ}=25^{\circ}C$ $T_{VJ}=-40^{\circ}C$	2 3	V
<b>I<sub>GT</sub></b>	$V_D=6V; T_{VJ}=25^{\circ}C$ $T_{VJ}=-40^{\circ}C$	150 200	mA
<b>V<sub>GD</sub></b>	$T_{VJ}=T_{VJM}; V_D=2/3V_{DRM}$	0.25	V
<b>I<sub>GD</sub></b>		10	mA
<b>I<sub>L</sub></b>	$T_{VJ}=25^{\circ}C; t_p=30\mu s; V_D=6V$ $I_G=0.45A; di_G/dt=0.45A/\mu s$	300	mA
<b>I<sub>H</sub></b>	$T_{VJ}=25^{\circ}C; V_D=6V; R_{GK}=\infty$	150	mA
<b>t<sub>gd</sub></b>	$T_{VJ}=25^{\circ}C; V_D=1/2V_{DRM}$ $I_G=1A; di_G/dt=1A/\mu s$	2	us
<b>t<sub>q</sub></b>	$T_{VJ}=T_{VJM}; I_T=300A; t_p=200\mu s; -di/dt=10A/\mu s$ $V_R=100V; dv/dt=50V/\mu s; V_D=2/3V_{DRM}$	typ. 200	us
<b>Q<sub>s</sub></b>	$T_{VJ}=125^{\circ}C; I_T, I_F=400A; -di/dt=50A/\mu s$	760	uC
<b>I<sub>RM</sub></b>		275	A
<b>R<sub>thJC</sub></b>	per thyristor/diode; DC current per module	0.129 0.0645	K/W
<b>R<sub>thJK</sub></b>	per thyristor/diode; DC current per module	0.169 0.0845	K/W
<b>d<sub>s</sub></b>	Creeping distance on surface	12.7	mm
<b>d<sub>A</sub></b>	Strike distance through air	9.6	mm
<b>a</b>	Maximum allowable acceleration	50	m/s <sup>2</sup>

### FEATURES

- \* International standard package
- \* Copper base plate
- \* Planar passivated chips
- \* Isolation voltage 3600 V~

### APPLICATIONS

- \* Motor control
- \* Power converter
- \* Heat and temperature control for industrial furnaces and chemical processes
- \* Lighting control
- \* Contactless switches

### ADVANTAGES

- \* Space and weight savings
- \* Simple mounting
- \* Improved temperature and power cycling
- \* Reduced protection circuits

# STD/SDT253

## Thyristor-Diode Modules, Diode-Thyristor Modules

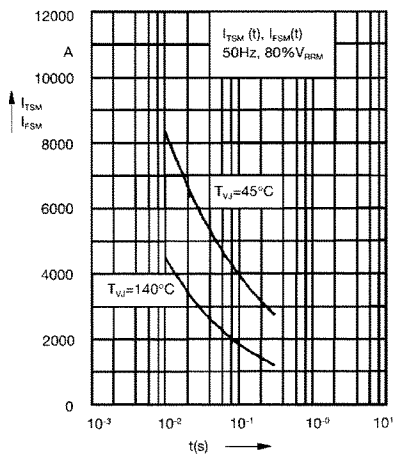

Fig. 1 Surge overload current  
 $I_{TSM}$ ,  $I_{FSM}$ : Crest value, t: duration

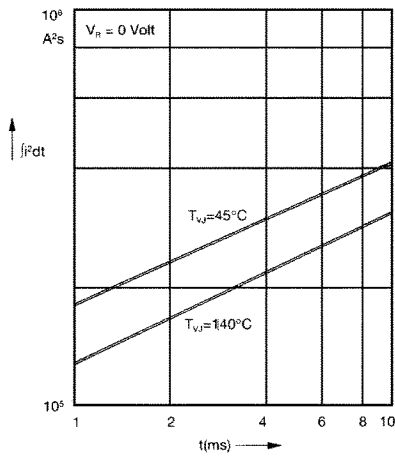

Fig. 2  $\int i^2 dt$  versus time (1-10 ms)

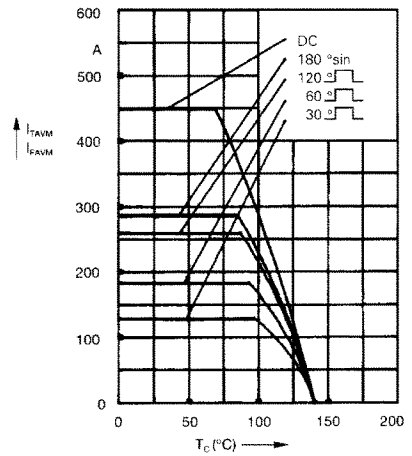

Fig. 2a Maximum forward current at case temperature

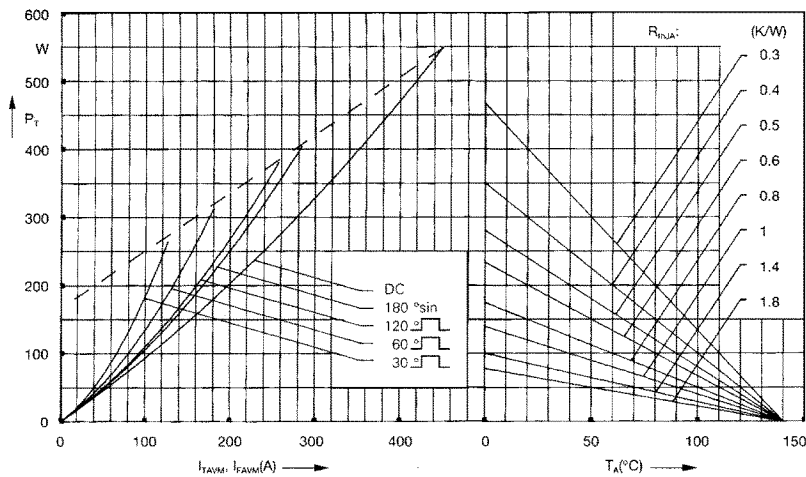

Fig. 3 Power dissipation versus on-state current and ambient temperature (per thyristor or diode)

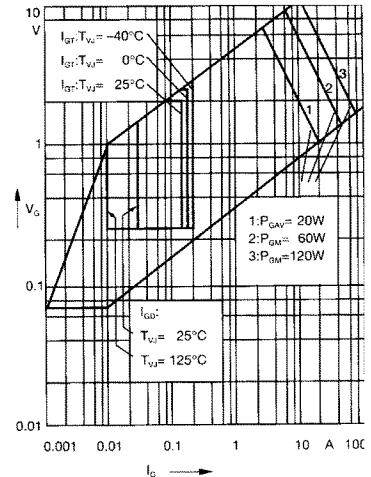

Fig. 4 Gate trigger characteristics

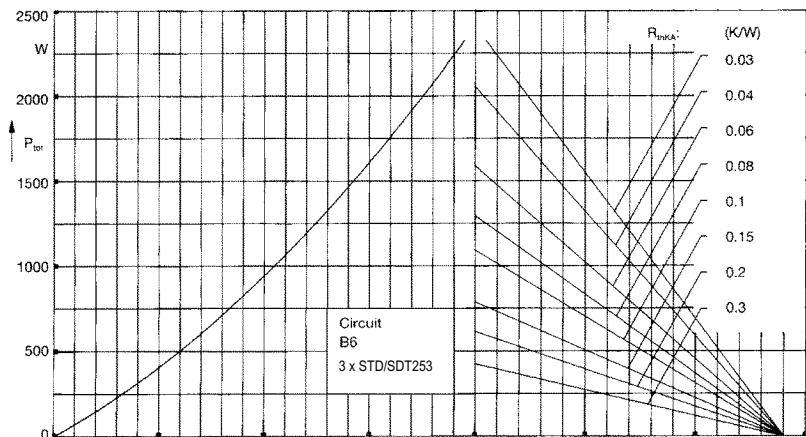

Fig. 5 Three phase rectifier bridge: Power dissipation versus direct output current and ambient temperature

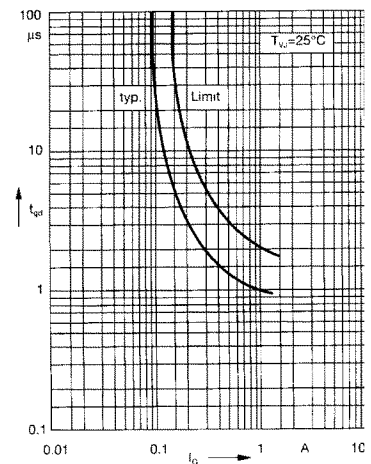

Fig. 6 Gate trigger delay time

# STD/SDT253

## Thyristor-Diode Modules, Diode-Thyristor Modules

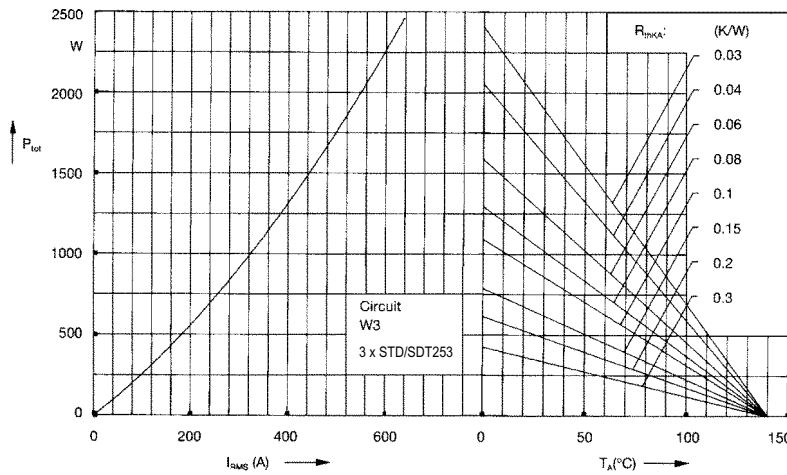

Fig. 7 Three phase AC-controller: Power dissipation versus RMS output current and ambient temperature

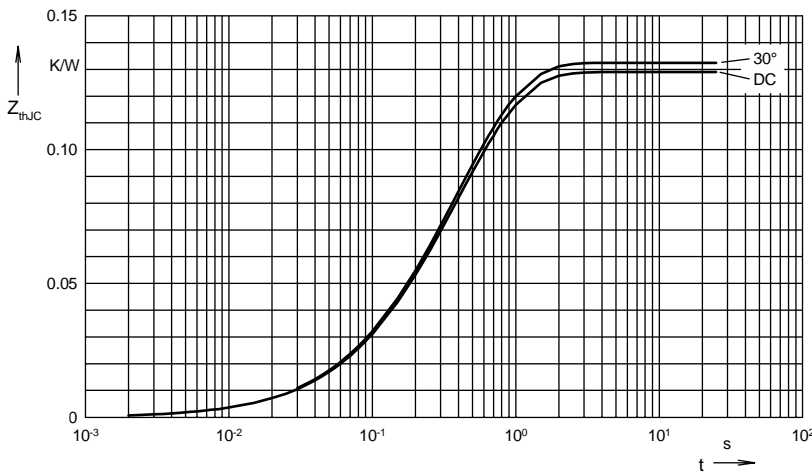

Fig. 8 Transient thermal impedance junction to case (per thyristor or diode)

$R_{thjC}$  for various conduction angles  $d$ :

$d$	$R_{thjC}$ (K/W)
DC	0.129
180°	0.131
120°	0.131
60°	0.132
30°	0.132

Constants for  $Z_{thjC}$  calculation:

$i$	$R_{thi}$ (K/W)	$t_i$ (s)
1	0.0035	0.099
2	0.0165	0.168
3	0.1091	0.456

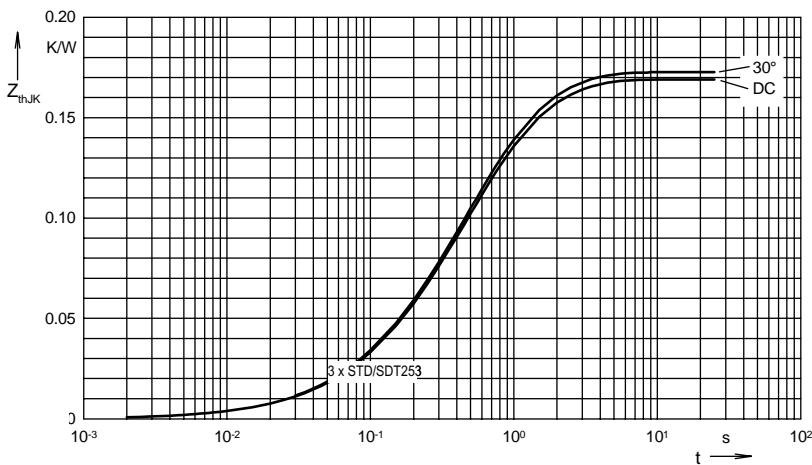

Fig. 9 Transient thermal impedance junction to heatsink (per thyristor or diode)

$R_{thjK}$  for various conduction angles  $d$ :

$d$	$R_{thjK}$ (K/W)
DC	0.169
180°	0.171
120°	0.172
60°	0.172
30°	0.173

Constants for  $Z_{thjK}$  calculation:

$i$	$R_{thi}$ (K/W)	$t_i$ (s)
1	0.0033	0.099
2	0.0159	0.168
3	0.1053	0.456
4	0.04	1.36