



## A5A:1450.XX

### VOLTAGE RATINGS

Part Number	$V_{RRM}, V_R$ (V) Max. rep. peak reverse voltage		$V_{RSM}, V_R$ (V) Max. non-rep. peak reverse voltage
	$T_J = 0$ to $175^\circ\text{C}$	$T_J = -40$ to $0^\circ\text{C}$	$T_J = 25$ to $175^\circ\text{C}$
	A5A:1450.24	2400	2400
A5A:1450.26	2600	2600	2700
A5A:1450.28	2800	2800	2900
A5A:1450.30	3000	3000	3100
A5A:1450.32	3200	3200	3300
A5A:1450.34	3400	3400	3500
A5A:1450.36	3600	3600	3700
A5A:1450.38	3800	3800	3900
A5A:1450.40	4000	4000	4100
A5A:1450.42	4200	4200	4300

### MAXIMUM ALLOWABLE RATINGS

PARAMETER	VALUE	UNITS	NOTES
$T_J$ Junction Temperature	-40 to 175	$^\circ\text{C}$	-
$T_{stg}$ Storage Temperature	-40 to 175	$^\circ\text{C}$	-
$I_{F(AV)}$ Max. Av. current @ Max. $T_C$	1100	A	180° half sine wave
	125	$^\circ\text{C}$	
$I_{F(RMS)}$ Nom. RMS current	2290	A	-
$I_{FSM}$ Max. Peak non-rep. surge current	17.2	kA	50 Hz half cycle sine wave Initial $T_J = 175^\circ\text{C}$ , rated $V_{RRM}$ applied after surge.
	18.8		60 Hz half cycle sine wave
	19.6		50 Hz half cycle sine wave Initial $T_J = 175^\circ\text{C}$ , no voltage applied after surge.
	21.4		60 Hz half cycle sine wave
$I^2t$ Max. $I^2t$ capability	1535	$\text{kA}^2\text{s}$	$t = 10\text{ms}$ Initial $T_J = 175^\circ\text{C}$ , rated $V_{RRM}$ applied after surge.
	1674		$t = 8.3\text{ms}$
	1750		$t = 10\text{ms}$ Initial $T_J = 175^\circ\text{C}$ , no voltage applied after surge.
	1908		$t = 8.3\text{ms}$
$I^2t^{1/2}$ Max. $I^2t^{1/2}$ capability	20900	$\text{kA}^2\text{s}^{1/2}$	Initial $T_J = 175^\circ\text{C}$ , no voltage applied after surge. $I^2t$ for time $t_x = I^2t^{1/2} * t_x^{1/2}$ . ( $0.1 < t_x < 10\text{ms}$ ).
F Mounting Force	2500	N.m	-



# A5A:1450.XX

## CHARACTERISTICS

PARAMETER	MIN.	TYP.	MAX.	UNITS	TEST CONDITIONS
V <sub>FM</sub> Peak forward voltage	---	1.5	2.05	V	Initial T <sub>J</sub> = 25°C, 50-60Hz half sine, I <sub>peak</sub> = 3456A.
V <sub>(TO)</sub> Threshold voltage	---	---	1.06	V	T <sub>J</sub> = 175°C, Av. power = V <sub>F(TO)</sub> * I <sub>F(AV)</sub> + r <sub>F</sub> * [I <sub>F(RMS)</sub> ] <sup>2</sup>
r <sub>F</sub> Slope resistance	---	---	0.305	m	Use low values for I <sub>FM</sub> < I <sub>F(AV)</sub>
I <sub>RM</sub> Peak reverse current	---	60	125	mA	T <sub>J</sub> = 175°C. Max. rated V <sub>RRM</sub>
R <sub>thJC</sub> Thermal resistance, junction-to-case	---	---	0.023	°C/W	DC operation, double side
	---	---	0.025	°C/W	180° sine wave, double side
	---	---	0.025	°C/W	120° rectangular wave, duple side
R <sub>thCS</sub> Thermal resistance, case-to-sink	---	---	0.01	°C/W	Mtg. Surface smooth, flat and greased. Single side. For double side, divide value by 2.
wt Weight	---	425	---	g(oz.)	---
Case Style	A-24				---

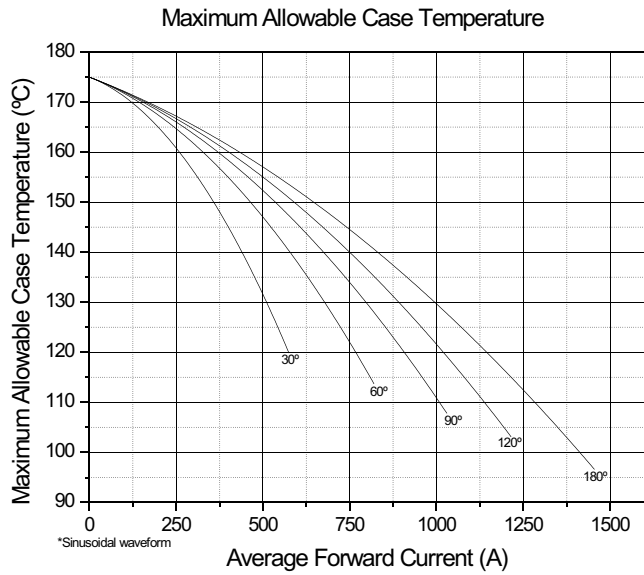

Fig. 1 - Current Ratings Characteristics

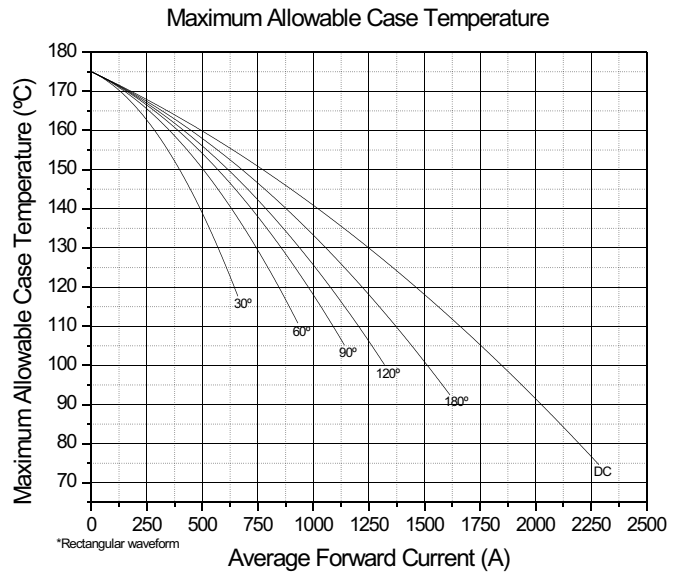
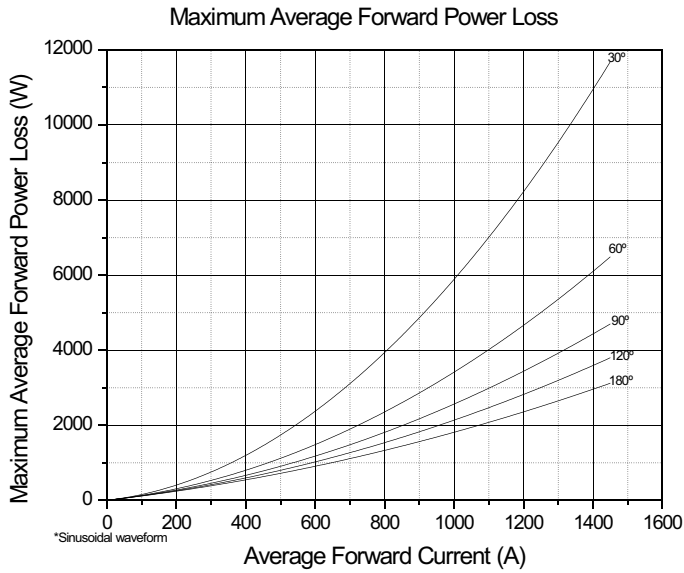

Fig. 2 - Current Ratings Characteristics



## A5A:1450.XX



**Fig. 3 - Average Forward Power Loss Characteristics**

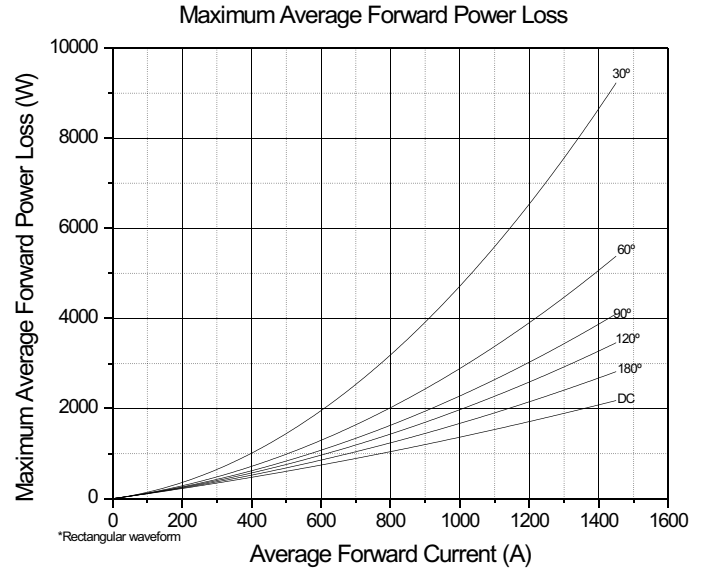

**Fig. 4 - Average Forward Power Loss Characteristics**

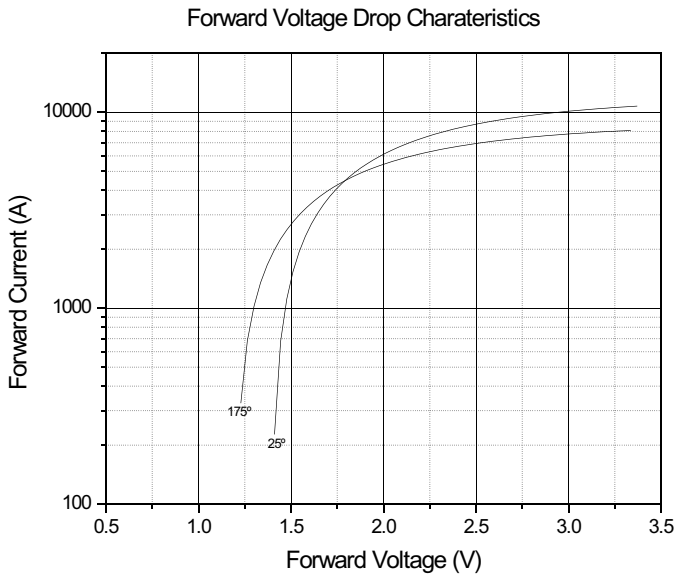

**Fig. 5 - Forward Voltage Drop Characteristics**

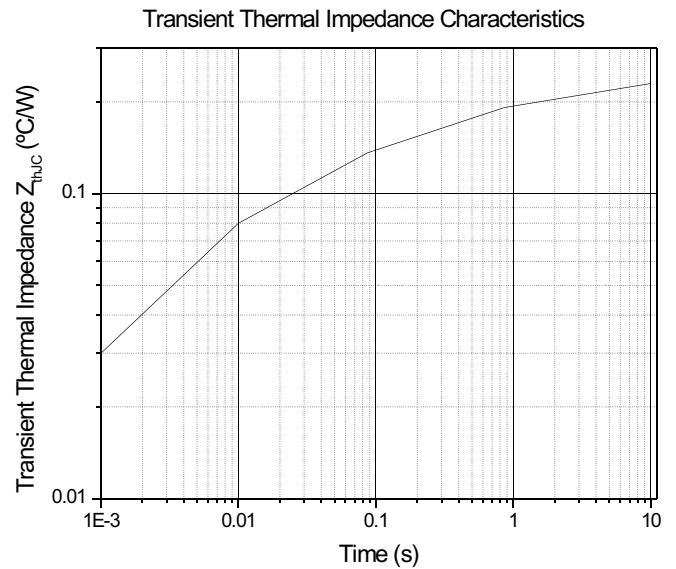
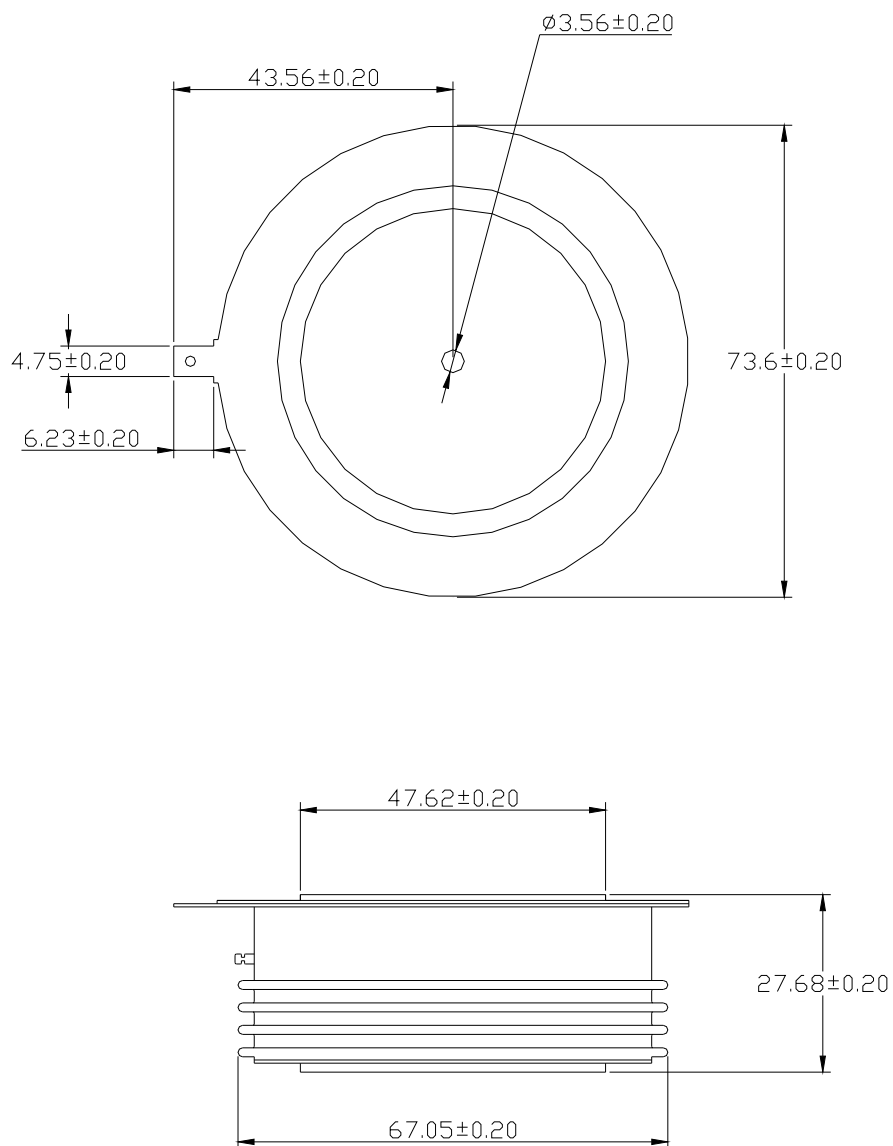

**Fig. 6 - Transient Thermal Impedance  $Z_{thJC}$  Characteristics**



# A5A:1450.XX

## A-24



**Fig. 7 - Outline Characteristics**