

KK74ACT323

8-Bit Bidirectional Universal Shift Register with Parallel I/O High-Speed Silicon-Gate CMOS

The KK74ACT323 is identical in pinout to the LS/ALS323, HC/HCT323. The KK74ACT323 may be used as a level converter for interfacing TTL or NMOS outputs to High Speed CMOS inputs.

The KK74ACT323 features a multiplexed parallel input/output data port to achieve full 8-bit handling in a 20 pin package. Due to the large output drive capability and the 3-state feature, this device is ideally suited for interface with bus lines in a bus-oriented system.

Two Mode-Select inputs and two Output Enable inputs are used to choose the mode of operation as listed in the Function Table. Synchronous parallel loading is accomplished by taking both Mode-Select lines, S₁ and S₂, high. This places the outputs in the high-impedance state, which permits data applied to the data port to be clocked into the register. Reading out of the register can be accomplished when the outputs are enabled. The active-low synchronous Reset overrides all other inputs.

- TTL/NMOS Compatible Input Levels
- Outputs Directly Interface to CMOS, NMOS, and TTL
- Operating Voltage Range: 4.5 to 5.5 V
- Low Input Current: 1.0 μA; 0.1 μA @ 25°C
- Outputs Source/Sink 24 mA

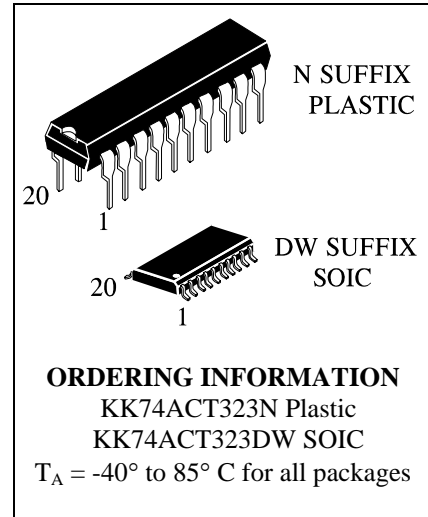

PIN ASSIGNMENT

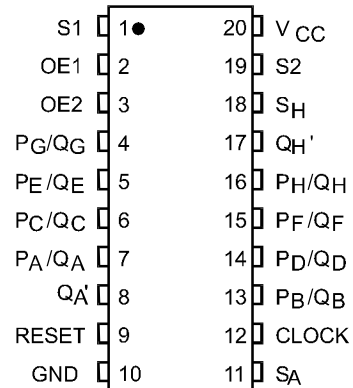

LOGIC DIAGRAM

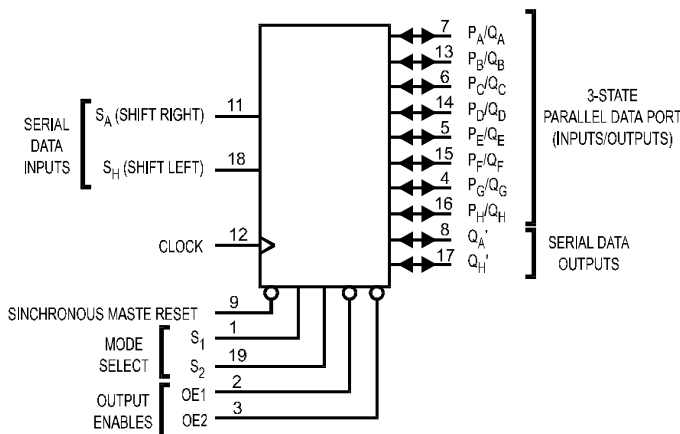

PIN 20 = V_{CC}
PIN 10 = GND

MAXIMUM RATINGS*

Symbol	Parameter	Value	Unit
V _{CC}	DC Supply Voltage (Referenced to GND)	-0.5 to +7.0	V
V _{IN}	DC Input Voltage (Referenced to GND)	-0.5 to V _{CC} +0.5	V
V _{OUT}	DC Output Voltage (Referenced to GND)	-0.5 to V _{CC} +0.5	V
I _{IN}	DC Input Current, per Pin	±20	mA
I _{OUT}	DC Output Sink/Source Current, per Pin	±50	mA
I _{CC}	DC Supply Current, V _{CC} and GND Pins	±50	mA
P _D	Power Dissipation in Still Air, Plastic DIP+ SOIC Package+	750 500	mW
T _{stg}	Storage Temperature	-65 to +150	°C
T _L	Lead Temperature, 1 mm from Case for 10 Seconds (Plastic DIP or SOIC Package)	260	°C

*Maximum Ratings are those values beyond which damage to the device may occur. Functional operation should be restricted to the Recommended Operating Conditions.

+Derating - Plastic DIP: - 10 mW/°C from 65° to 125°C

SOIC Package: - 7 mW/°C from 65° to 125°C

RECOMMENDED OPERATING CONDITIONS

Symbol	Parameter	Min	Max	Unit
V _{CC}	DC Supply Voltage (Referenced to GND)	4.5	5.5	V
V _{IN} , V _{OUT}	DC Input Voltage, Output Voltage (Referenced to GND)	0	V _{CC}	V
T _J	Junction Temperature (PDIP)		140	°C
T _A	Operating Temperature, All Package Types	-40	+85	°C
I _{OH}	Output Current - High		-24	mA
I _{OL}	Output Current - Low		24	mA
t _r , t _f	Input Rise and Fall Time * (except Schmitt Inputs)	V _{CC} =4.5 V 0 V _{CC} =5.5 V 0	10 8.0	ns/V

* V_{IN} from 0.8 V to 2.0 V

This device contains protection circuitry to guard against damage due to high static voltages or electric fields. However, precautions must be taken to avoid applications of any voltage higher than maximum rated voltages to this high-impedance circuit. For proper operation, V_{IN} and V_{OUT} should be constrained to the range GND ≤ (V_{IN} or V_{OUT}) ≤ V_{CC}.

Unused inputs must always be tied to an appropriate logic voltage level (e.g., either GND or V_{CC}). Unused outputs must be left open.

DC ELECTRICAL CHARACTERISTICS (Voltages Referenced to GND)

Symbol	Parameter	Test Conditions	V _{CC} V	Guaranteed Limits		Unit
				25 °C	-40°C to 85°C	
V _{IH}	Minimum High-Level Input Voltage	V _{OUT} = 0.1 V or V _{CC} -0.1 V	4.5 5.5	2.0 2.0	2.0 2.0	V
V _{IL}	Maximum Low - Level Input Voltage	V _{OUT} = 0.1 V or V _{CC} -0.1 V	4.5 5.5	0.8 0.8	0.8 0.8	V
V _{OH}	Minimum High-Level Output Voltage	I _{OUT} ≤ -50 μA	4.5 5.5	4.4 5.4	4.4 5.4	V
		*V _{IN} =V _{IH} or V _{IL} I _{OH} =-24 mA	4.5	3.86	3.76	
		I _{OH} =-24 mA	5.5	4.86	4.76	
V _{OL}	Maximum Low-Level Output Voltage	I _{OUT} ≤ 50 μA	4.5 5.5	0.1 0.1	0.1 0.1	V
		*V _{IN} = V _{IH} or V _{IL} I _{OL} =24 mA	4.5	0.36	0.44	
		I _{OL} =24 mA	5.5	0.36	0.44	
I _{IN}	Maximum Input Leakage Current	V _{IN} =V _{CC} or GND	5.5	±0.1	±1.0	μA
ΔI _{CCT}	Additional Max. I _{CC} /Input	V _{IN} =V _{CC} - 2.1 V	5.5		1.5	mA
I _{OZ}	Maximum Three-State Leakage Current	V _{IN} (OE)= V _{IH} or V _{IL} V _{IN} =V _{CC} or GND V _{OUT} =V _{CC} or GND	5.5	±0.6	±6.0	μA
I _{OLD}	+Minimum Dynamic Output Current	V _{OLD} =1.65 V Max	5.5		75	mA
I _{OHD}	+Minimum Dynamic Output Current	V _{OHD} =3.85 V Min	5.5		-75	mA
I _{CC}	Maximum Quiescent Supply Current (per Package)	V _{IN} =V _{CC} or GND	5.5	8.0	80	μA

* All outputs loaded; thresholds on input associated with output under test.

+Maximum test duration 2.0 ms, one output loaded at a time.









AC ELECTRICAL CHARACTERISTICS ($V_{CC}=5.0\text{ V} \pm 10\%$, $C_L=50\text{pF}$, Input $t_r=t_f=3.0\text{ ns}$)

Symbol	Parameter	Guaranteed Limits				Unit
		25 °C		-40°C to 85°C		
		Min	Max	Min	Max	
f_{\max}	Maximum Clock Frequency (Figure 1)	120		110		MHz
t_{PLH}	Propagation Delay, Clock to Q_A' or Q_H' (Figure 1)	5.0	12.5	4.0	14.0	ns
t_{PHL}	Propagation Delay, Clock to Q_A' or Q_H' (Figure 1)	5.0	13.5	4.5	15.0	ns
t_{PLH}	Propagation Delay, Clock to Q_A thru Q_H (Figure 1)	5.0	12.5	4.5	13.5	ns
t_{PHL}	Propagation Delay, Clock to Q_A thru Q_H (Figure 1)	6.0	15.0	5.0	16.5	ns
t_{PZH}	Propagation Delay, OE1, OE2 to Q_A thru Q_H (Figure 3)	3.5	11.0	3.0	12.5	ns
t_{PZL}	Propagation Delay, OE1, OE2 to Q_A thru Q_H (Figure 3)	3.5	11.5	3.0	13.0	ns
t_{PHZ}	Propagation Delay, OE1, OE2 to Q_A thru Q_H (Figure 3)	4.0	12.5	3.0	13.5	ns
t_{PLZ}	Propagation Delay, OE1, OE2 to Q_A thru Q_H (Figure 3)	3.0	11.5	2.5	12.5	ns
C_{IN}	Maximum Input Capacitance	4.5		4.5		pF
C_{PD}	Power Dissipation Capacitance	Typical @25°C, $V_{CC}=5.0\text{ V}$				pF
		170				

TIMING REQUIREMENTS($V_{CC}=5.0\text{ V} \pm 10\%$, $C_L=50\text{pF}$, Input $t_r=t_f=3.0\text{ ns}$)

Symbol	Parameter	Guaranteed Limits		Unit
		25 °C	-40°C to 85°C	
t_{su}	Minimum Setup Time, Mode Select S1 or S2 to Clock (Figure 4)	5.0	5.0	ns
t_{su}	Minimum Setup Time, Data Inputs P_A thru P_H to Clock (Figure 4)	4.0	4.5	ns
t_{su}	Minimum Setup Time, Data Inputs S_A , S_H to Clock (Figure 4)	4.5	5.0	ns
t_{su}	Minimum Setup Time, Reset to Clock (Figure 2)	2.5	2.5	ns
t_h	Minimum Hold Time, Clock to Mode Select S1 or S2 (Figure 4)	1.5	1.5	ns
t_h	Minimum Hold Time, Clock to Data Inputs P_A thru P_H (Figure 4)	1.0	1.0	ns
t_h	Minimum Hold Time, Clock to Data Inputs S_A , S_H (Figure 4)	1.0	1.0	ns
t_h	Minimum Hold Time, Clock to Reset (Figure 2)	1.0	1.0	ns
t_w	Minimum Pulse Width, Clock (Figure 1)	4.0	4.5	ns

FUNCTION TABLE

Inputs									Response									
Mode	Reset	Mode Select		Output Enables		Clock	Serial Inputs		P _A /Q _A	P _B /Q _B	P _C /Q _C	P _D /Q _D	P _E /Q _E	P _F /Q _F	P _G /Q _G	P _H /Q _H	Q _A '	Q _H '
		S ₂	S ₁	OE1 [↑]	OE2 [↑]		D _A	D _H										
Reset	L	X	L	L	L		X	X	L	L	L	L	L	L	L	L	L	L
	L	L	X	L	L		X	X	L	L	L	L	L	L	L	L	L	L
	L	H	H	X	X	X	X	X	Q _A through Q _H =Z							L	L	
Shift Right	H	L	H	H	X		D	X	Shift Right: Q _A through Q _H =Z; D _A →F _A ; F _A →F _B ; etc							D	Q _G	
	H	L	H	X	H		D	X	Shift Right: Q _A through Q _H =Z; D _A →F _A ; F _A →F _B ; etc							D	Q _G	
	H	L	H	L	L		D	X	Shift Right: D _A →F _A =Q _A ; F _A →F _B =Q _B ; etc							D	Q _G	
Shift Left	H	H	L	H	X		X	D	Shift Left: Q _A through Q _H =Z; D _H →F _H ; F _H →F _G ; etc							Q _B	D	
	H	H	L	X	H		X	D	Shift Left: Q _A through Q _H =Z; D _H →F _H ; F _H →F _G ; etc							Q _B	D	
	H	H	L	L	L		X	D	Shift Left: D _H →F _H =Q _H ; F _H →F _G =Q _G ; etc							Q _B	D	
Parallel Load	H	H	H	X	X		X	X	Parallel Load: P _N →F _N							P _A	P _H	
Hold	H	L	L	H	X	X	X	X	Hold: Q _A through Q _H =Z; F _N =F _N							P _A	P _H	
	H	L	L	X	H	X	X	X	Hold: Q _A through Q _H =Z; F _N =F _N							P _A	P _H	
	H	L	L	L	L	X	X	X	Hold: Q _N =Q _H							P _A	P _H	

Z = high impedance

D = data on serial input

F = flip-flop (see Logic Diagram)

[↑] When one or both output controls are high the eight input/output terminals are disabled to the high-impedance state; however, sequential operation or clearing of the register is not affected.

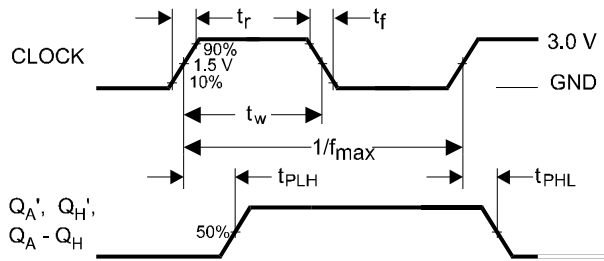

Figure 1. Switching Waveform

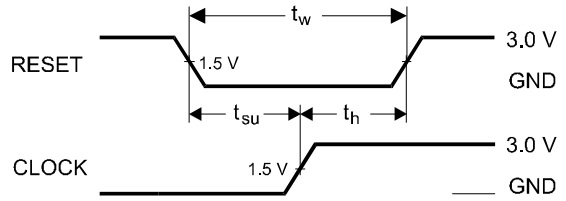

Figure 2. Switching Waveform

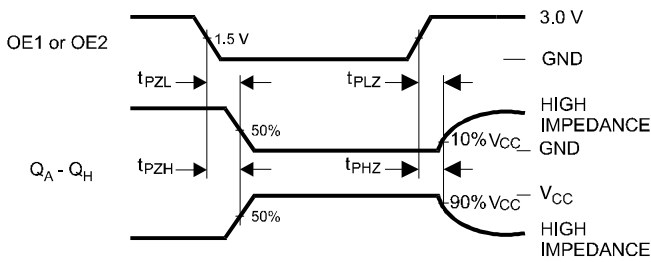

Figure 3. Switching Waveform

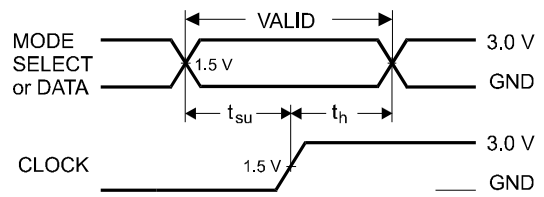
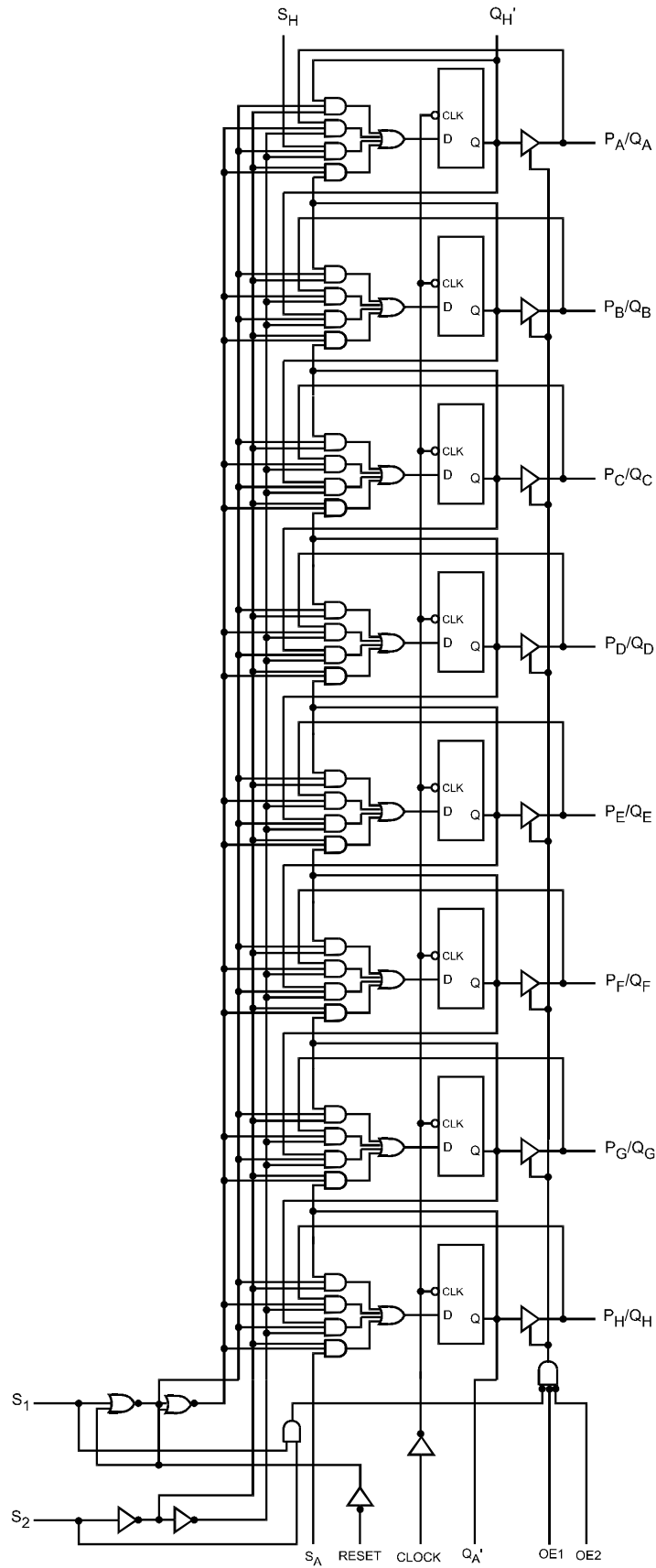
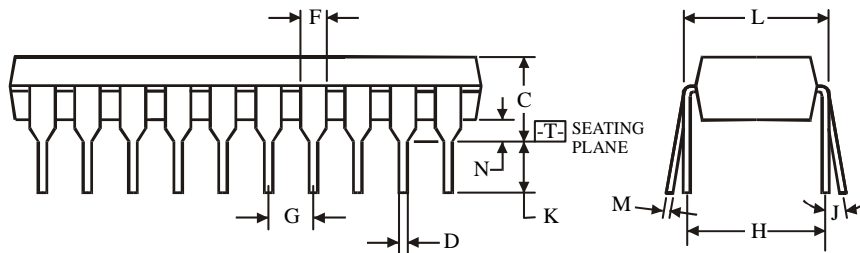
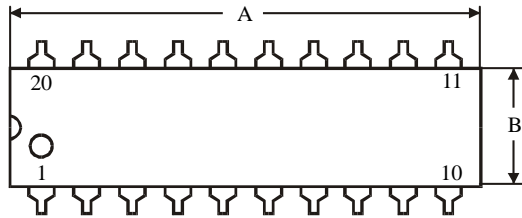
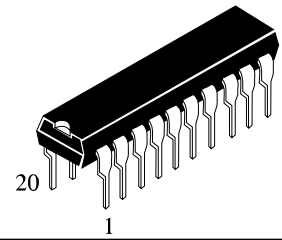

Figure 4. Switching Waveform

EXPANDED LOGIC DIAGRAM



N SUFFIX PLASTIC DIP (MS - 001AD)



$\oplus 0.25 (0.010) \text{M} \text{T}$

NOTES:

- Dimensions "A", "B" do not include mold flash or protrusions.
Maximum mold flash or protrusions 0.25 mm (0.010) per side.

Symbol	Dimension, mm	
	MIN	MAX
A	24.89	26.92
B	6.1	7.11
C		5.33
D	0.36	0.56
F	1.14	1.78
G	2.54	
H	7.62	
J	0°	10°
K	2.92	3.81
L	7.62	8.26
M	0.2	0.36
N	0.38	

D SUFFIX SOIC (MS - 013AC)

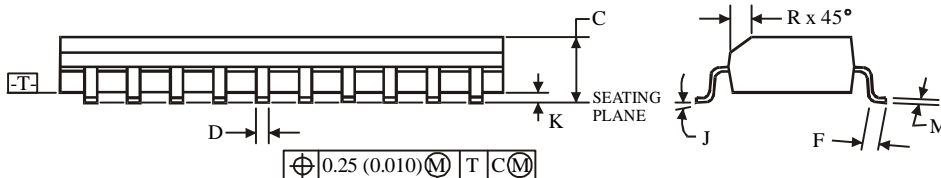
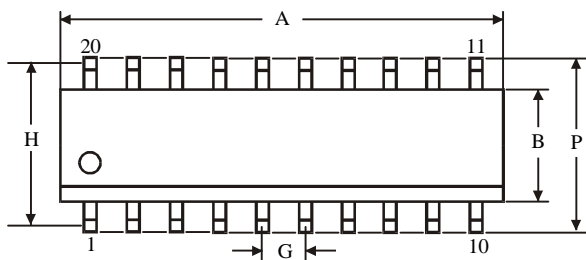
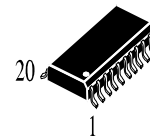

$\oplus 0.25 (0.010) \text{M} \text{T} \text{C} \text{M}$

NOTES:

- Dimensions A and B do not include mold flash or protrusion.
- Maximum mold flash or protrusion 0.15 mm (0.006) per side
for A; for B - 0.25 mm (0.010) per side.

Symbol	Dimension, mm	
	MIN	MAX
A	12.6	13
B	7.4	7.6
C	2.35	2.65
D	0.33	0.51
F	0.4	1.27
G	1.27	
H	9.53	
J	0°	8°
K	0.1	0.3
M	0.23	0.32
P	10	10.65
R	0.25	0.75