

Features

- 2.3 INCH DIGIT HEIGHT.
- LOW CURRENT OPERATION.
- EXCELLENT CHARACTER APPEARANCE.
- HIGH LIGHT OUTPUT.
- EASY MOUNTING ON P.C. BOARDS OR SOCKETS.
- MULTICOLOR AVAILABLE.
- MECHANICALLY RUGGED.
- GRAY FACE, WHITE SEGMENT.
- RoHS COMPLIANT.

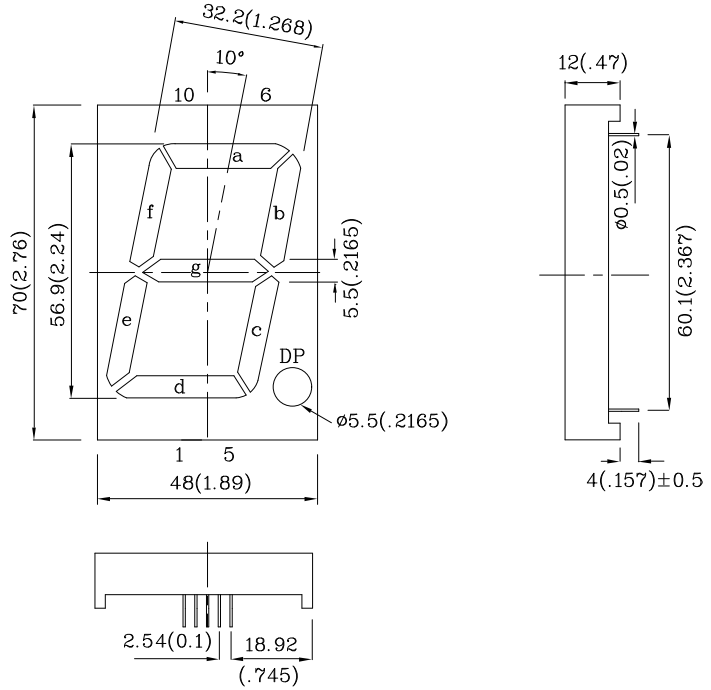
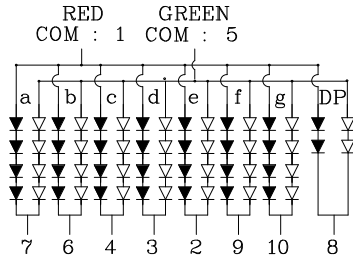

Notes:

1. All dimensions are in millimeters (inches).
2. Tolerance is ± 0.25(0.01") unless otherwise noted.
3. Specifications are subject to change without notice.

Absolute Maximum Ratings (TA=25°C)		UR (GaAsP /GaP)	UG (GaP)	Unit
Reverse Voltage Per Segment or (DP)	V _R	20 (10)	20 (10)	V
Forward Current Per Segment or (DP)	I _F	30 (30)	25 (25)	mA
Forward Current (Peak) Per Segment or (DP) 1/10 Duty Cycle 0.1ms Pulse Width	i _{FS}	160 (160)	140 (140)	mA
Power Dissipation Per Segment or (DP)	P _T	300 (150)	250 (125)	mW
Operating Temperature	T _A	-40 ~ +85		°C
Storage Temperature	T _{stg}	-40 ~ +85		
Lead Solder Temperature [2mm Below Package Base]	260°C For 3~5 Seconds			

Operating Characteristics (TA=25°C)		UR (GaAsP /GaP)	UG (GaP)	Unit
Forward Voltage (Typ.) Per Segment or (DP) (I _F =10mA)	V _F	7.6 (3.8)	8.0 (4.0)	V
Forward Voltage (Max.) Per Segment or (DP) (I _F =10mA)	V _F	10.0 (5.0)	10.0 (5.0)	V
Reverse Current Per Segment or (DP) (V _R =20(10)V)	I _R	10	10	uA
Wavelength of Peak Emission (Typ.) (I _F =10mA)	λ _P	627	565	nm
Wavelength of Dominant Emission (Typ.) (I _F =10mA)	λ _D	625	568	nm
Spectral Line Full Width At Half-Maximum (Typ.) (I _F =10mA)	Δλ	45	30	nm
Capacitance (Typ.) (V _F =0V, f=1MHz)	C	15	15	pF

Part Number	Emitting Color	Emitting Material	Luminous Intensity (I _F =10mA) ucd		Wavelength nm λ _P	Description
			min.	typ.		
DURG57A-A	Red	GaAsP/GaP	12000	55490	627	Common Anode. Rt. Hand Decimal
	Green	GaP	12000	52990	565	

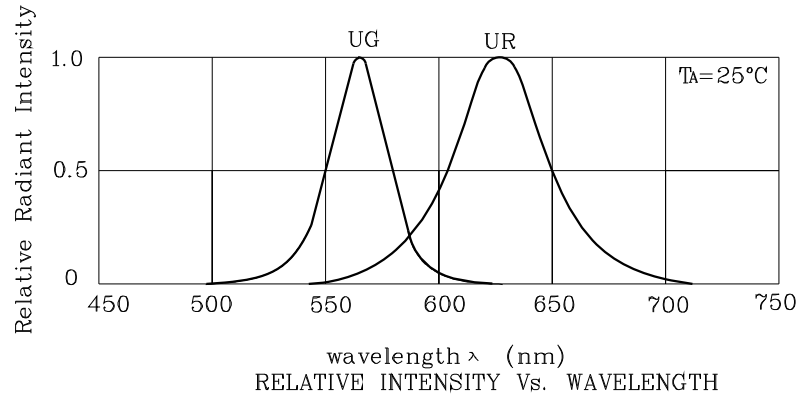

❖ UR

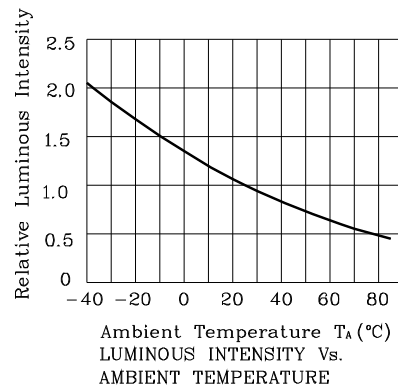
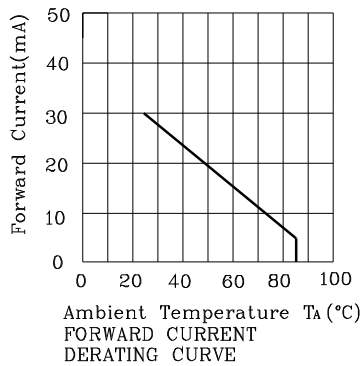
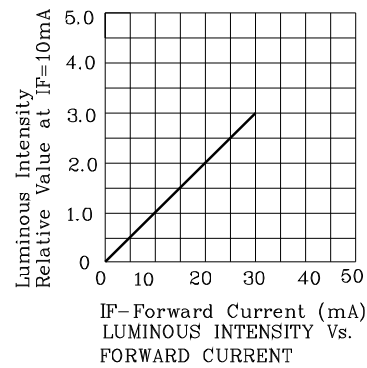
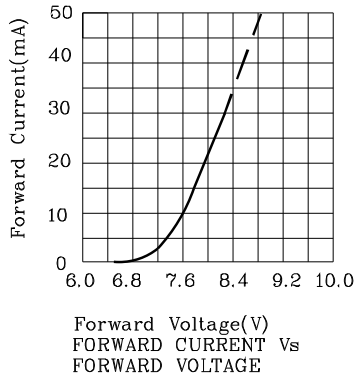

❖ UR

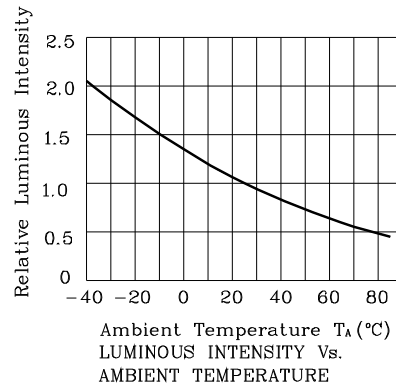
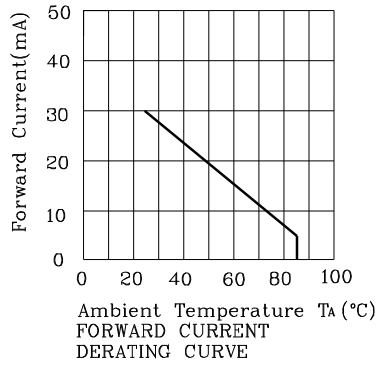
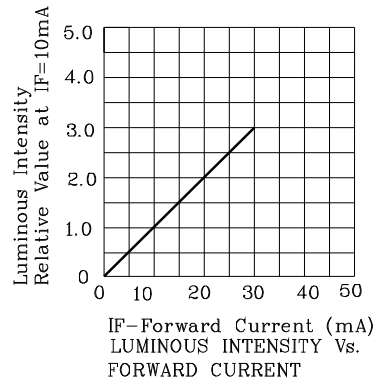
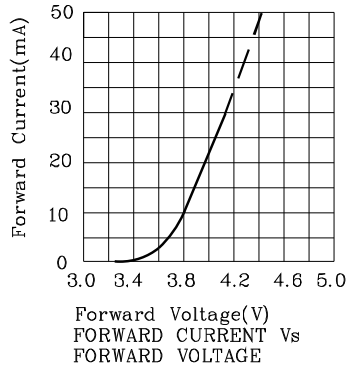

❖ UG

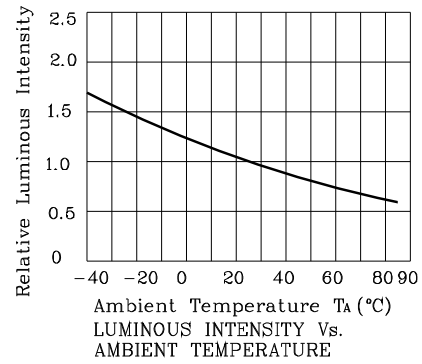
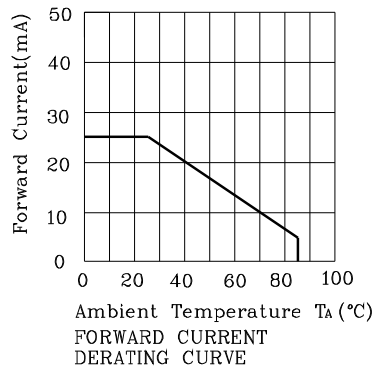
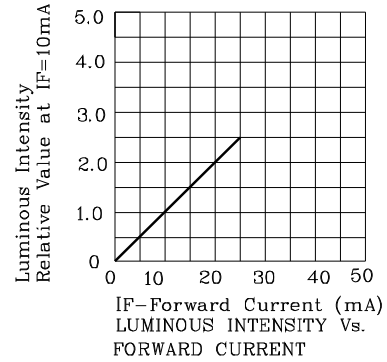
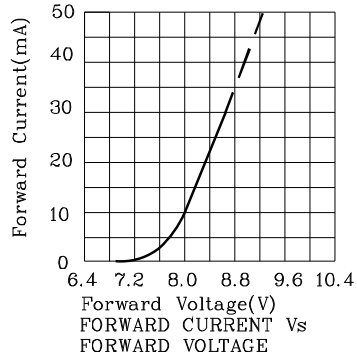

❖ UG

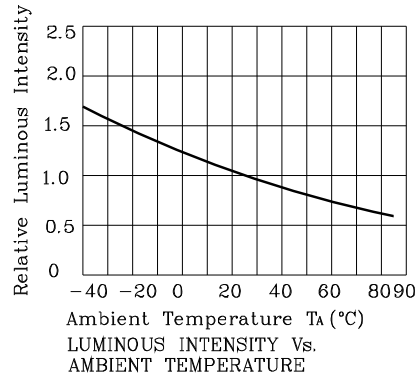
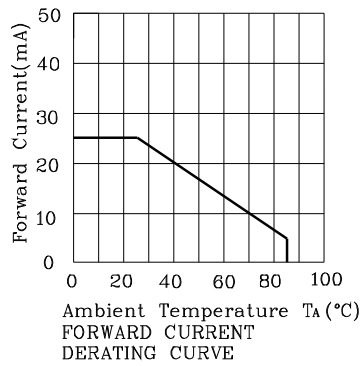
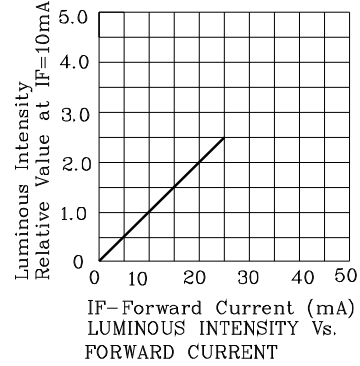
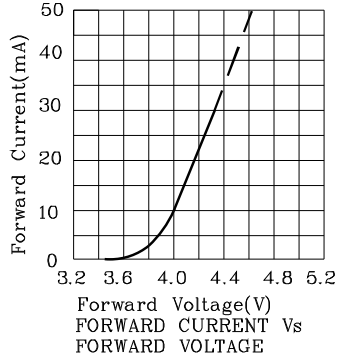

Wave Soldering Profile For Lead-free Through-hole LED.

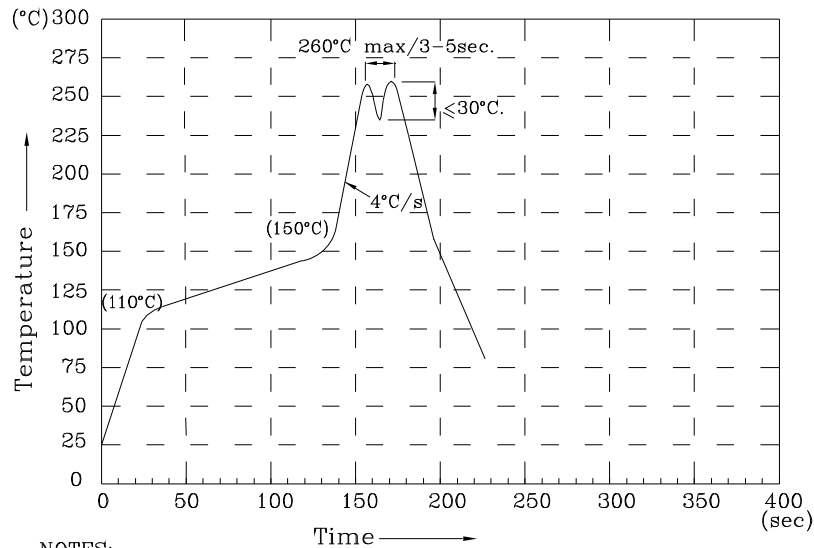

NOTES:

1. Recommend the wave temperature 245°C~260°C. The maximum soldering temperature should be less than 260°C.
2. Do not apply stress on epoxy resins when temperature is over 85 degree°C.
3. The soldering profile apply to the lead free soldering (Sn/Cu/Ag alloy).
4. No more than once.

Remarks:

If special sorting is required (e.g. binning based on forward voltage, luminous intensity/ luminous flux or wavelength), the typical accuracy of the sorting process is as follows:

1. Wavelength: +/-1nm
2. Luminous Intensity/ luminous flux: +/-15%
3. Forward Voltage: +/-0.1V

Note: Accuracy may depend on the sorting parameters.

PACKING & LABEL SPECIFICATIONS

DURG57A-A

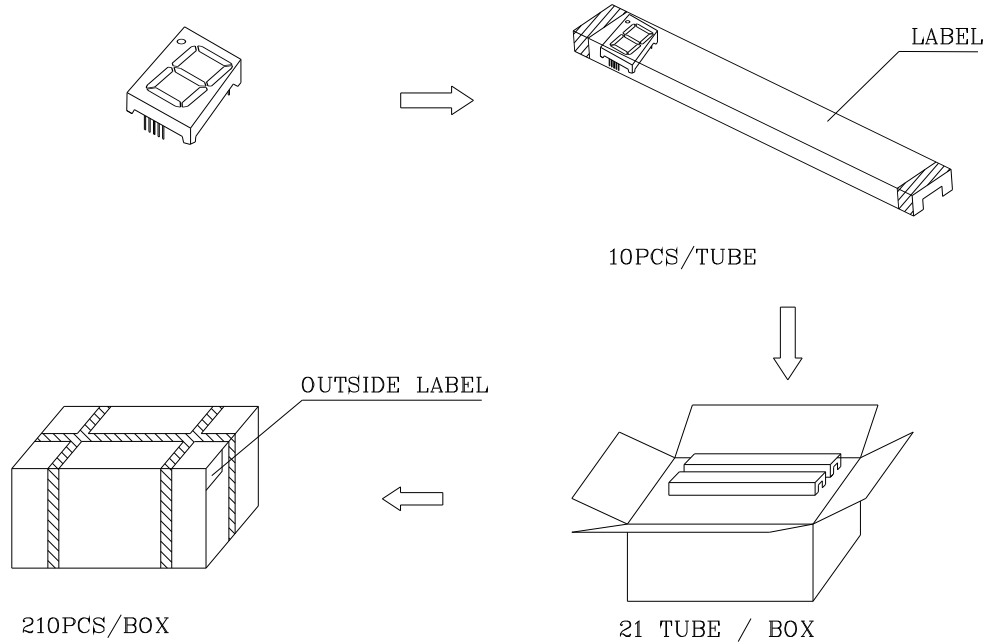

Inside LABEL Paste On The IC-tube

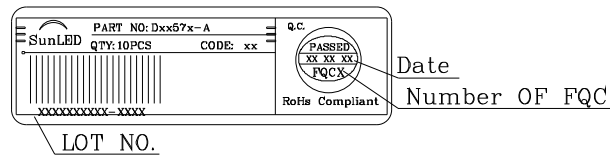

Outside LABEL Paste On The Box

