

MPQ24S5-50

**50 W DC-DC Converter
10-36 Vdc Input
5 Vdc Output at 10 A
Quarter-Brick Package**



Features:

- **Over 87% Efficient at Full Load**
- **Fast Transient Response**
- **Operation to No Load**
- **Output Trim +/-10%**
- **Remote ON/OFF**
- **Remote Sense Compensation**
- **Low Output Ripple**
- **Fixed Switching Frequency**
- **Output Over Current Protection**
- **Output Short Circuit Protection**
- **Over Temperature Protection**
- **1000 V Isolation**
- **100% Burn In**
- **Heatsink Available**

Description:

The MPQ24 series is a high density, low voltage input quarter brick converter that incorporates the desired features required in today's demanding applications while maintaining low cost. When performance, reliability, and low cost are needed, the MPQ series delivers.

Technical Specifications		Model No. MPQ24S5-50			
All specifications are based on 25 °C, Nominal Input Voltage and Maximum Output Current unless otherwise noted. We reserve the right to change specifications based on technological advances.					
SPECIFICATION	Related condition	Min	Nom	Max	Unit
Switching Frequency		-	200	-	kHz
INPUT (V_{in})					
Operating Voltage Range		10	24	36	Vdc
UVLO Turn On at		9.8	10.0	10.3	Vdc
UVLO Turn Off at		9.4	9.7	9.9	Vdc
UVLO Hysterisis		-	0.3	-	Vdc
Maximum Input Current (Graph 3)	Low Line	-	5.8	-	A
No Load Input Current (Graph 5)	No Load	-	0.081	-	A
Input Current under "Remote Off" (Graph 6)	Active High Unit	-	3.1	-	mA
Reflected Ripple Current (Photos 1 & 2)	Measured with a 120 uF Alum. Elect. Input Capacitor	-	192	-	mA
Input Surge Voltage	100 mS	-	-	50	Vdc
EFFICIENCY (Graph 1)		-	87	-	%
OUTPUT (V_o)					
Voltage Set Point	±Sense shorted to ±Vout	4.970	5.000	5.030	Vdc
		-0.60		+0.60	%
Voltage Adjustment (Table 2)	Max Output limited to 90W	4.50	5.00	5.50	Vdc
		-10%		+10%	%
Load Regulation (Graph 7)	±Sense shorted to ±Vout	-	0.02	0.1	%
Line Regulation (Graph 8)	±Sense shorted to ±Vout	-	0.02	0.1	%
Temperature Drift (Graph 9)		-	0.013	0.025	% / °C
Remote Sense Compensation	Max Output limited to 50W (as measured at the converter output pins)	-	-	5.50	Vdc
		-	-	10%	%
Ripple (Photos 7, 9 & 11)	With 1 uF ceramic & 10 uF Tantalum	-	82	100	mV _{pk-pk}
Spikes (Photos 7, 9 & 11)	With 1 uF ceramic & 10 uF Tantalum	-	82	150	mV _{pk-pk}
Current		0	-	10.0	A
Current Limit	Power Limited-Dependent upon SENSE compensation and TRIM adjustment	12	14	16	A
Over Voltage Limit		5.8	54.0	58	Vdc
DYNAMIC RESPONSE					
Load step / ΔV (Photos 8, 10 & 12)	25% to 100% I _o , di/dt=0.025A/uS	-	264	-	mV
Recovery Time (Photos 8, 10 & 12)	Recovery to within 1% Nominal Vout	-	1	-	ms
Turn On Delay (Photo 3)	From Vin(min) to Vout (mom)	-	10	-	ms
Turn On Overshoot (Photos 3 & 5)	Full Load Resistive	-	0.0	-	%
Hold Up Time (Photo 4)	From Vin (min) to V _{ULVO Turn Off}	0	-	-	mS
REMOTE ON/OFF					
Active High or Active Low (Add an 'R' to the end of the PN ie: MPQ24S5-50R)					
Remote ON – Active High	Min High to Enable	1.5	-	-	Vdc
Remote OFF – Active High	Max Low to Disable	-	-	0.3	Vdc
Remote ON/OFF pin Floating – Active High	Over Operating Voltage Range	1.6	-	5.2	Vdc
I _{ON/OFF} Sink to pull low – Active High	V _{ON/OFF} =0V, Vin=36 V	-	-	0.15	mA
Remote ON – Active Low	Max Low to Enable	-	-	0.8	Vdc
Remote OFF – Active Low	Min High to Disable	2.1	-	-	Vdc
Remote ON/OFF pin Floating – Active Low	Over Operating Voltage Range	2.3	-	6.2	Vdc
I _{ON/OFF} Sink to pull low – Active Low	V _{ON/OFF} =0V, Vin=36V	-	-	0.6	mA
I _{ON/OFF} Source to drive high – Active High or Low		-	0	-	mA
Turn On Delay – (Photo 5)	Enable (max Low) to Vout (min)	-	3	-	ms
Turn Off Delay – (Photo 6)	Enable (0V) to Vout (min)	-	-	100	uS
ISOLATION					
Input-Output	1 minute	1000	-	-	Vdc
Input/Output-Chassis	1 minute	1000	-	-	Vdc
Isolation Resistance	at 25°C	20	-	-	GΩ
Isolation Capacitance		-	0.01	-	uF
THERMAL					
Ambient (Graph 2)	Max. Ambient limited by Derating Curves (Graph 2)	-40	25	Graph 2	°C
Over Temperature Protection	Case Temperature	-	110	-	°C
Storage Temperature		-55	-	125	°C
MTBF	Calculated Using Bellcore TR-332 Method 1 case 3		1,250,300		hours
MECHANICAL					
Weight		-	61	-	g

Table 1: Pin Assignments

Pin #	Pin Name	Function	Comments
1	+Vin	Positive Input	
2	Enable	Remote On/Off	If not used, leave open for standard unit, short to -Vin on 'R' units.
3	-Vin	Negative Input	
4	+Vout	Negative Output	
5	+SENSE	Negative Remote Sense	If not used, short to -Vo.
6	TRIM	Output Voltage Trim	If not used, leave open.
7	-SENSE	Positive Remote Sense	If not used, short to +Vo.
8	-Vout	Positive Output	

Figure 1: Mechanical Dimensions

PIN DESIGNATION	PIN Ø
1 +Vin	Ø.062 [1.57]
2 ON/OFF	Ø.040 [1.02]
3 -Vin	Ø.062 [1.57]
4 +Vout	Ø.062 [1.57]
5 +SENSE	Ø.040 [1.02]
6 TRIM	Ø.040 [1.02]
7 -SENSE	Ø.040 [1.02]
8 -Vout	Ø.062 [1.57]

NOTES:

- PIN TO PIN TOLERANCE: ± .010 [± 0.25] MEASURED AT STANDOFF FEATURE ONLY, DATUM-B.
- PIN DIAMETER TOLERANCE OF: ± .005 [± 0.13] MEASUREMENT READING APPLIES TO AREA FROM INTERFACE-PLANE SURFACE DATUM-B TO END OF PIN ONLY.
- UNLESS OTHERWISE SPECIFIED.

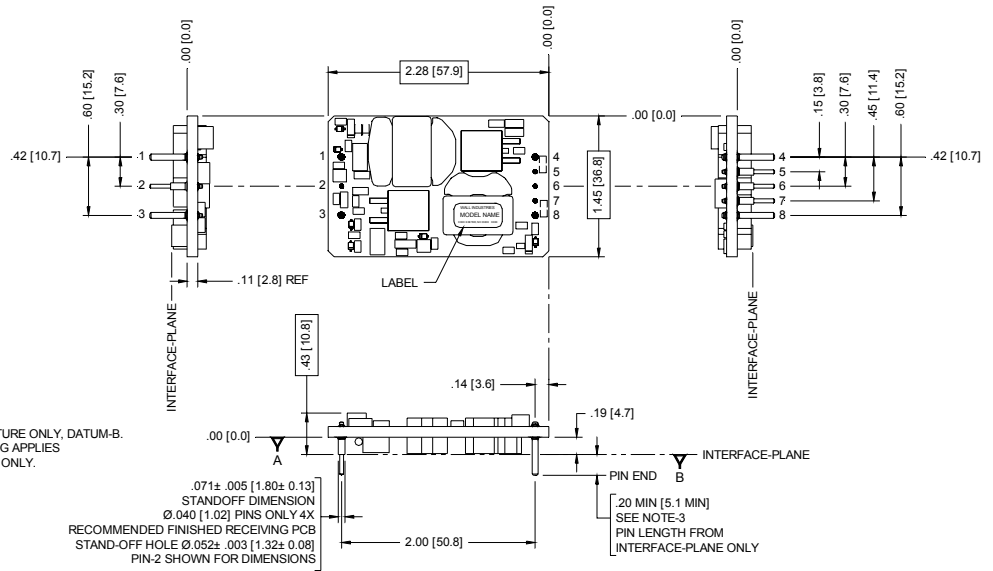

UNLESS OTHERWISE SPECIFIED
ALL DIMENSIONS ARE IN INCHES
(XX) ARE IN MILLIMETERS
APPLIED TOLERANCES:
ANGLES = ± 1°
XX± .02[0.5], .XX± .01[0.25]
DO NOT SCALE DRAWING
INTERPRET DIMENSION AND TOLERANCE
PER ASME Y14.5M - 1994

THIRD ANGLE PROJECTION

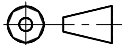

PIN DESIGNATION	PIN Ø
1 +Vin	Ø.062 [1.57]
2 ON/OFF	Ø.040 [1.02]
3 -Vin	Ø.062 [1.57]
4 +Vout	Ø.062 [1.57]
5 +SENSE	Ø.040 [1.02]
6 TRIM	Ø.040 [1.02]
7 -SENSE	Ø.040 [1.02]
8 -Vout	Ø.062 [1.57]

NOTES:

- PIN TO PIN TOLERANCE: ± .010 [± 0.25] MEASURED AT STANDOFF FEATURE ONLY, DATUM-B.
- PIN DIAMETER TOLERANCE OF: ± .005 [± 0.13] MEASUREMENT READING APPLIES TO AREA FROM INTERFACE-PLANE SURFACE DATUM-C TO END OF PIN ONLY.
- UNLESS OTHERWISE SPECIFIED.
- THERMAL TRANSFER PLATE MATERIAL: .040 [1.02] THICK ALUMINUM ALLOY 3003-0, PER: QQA 250/2 WITH BLACK SOFT SULFURIC ANODIZE FINISH.

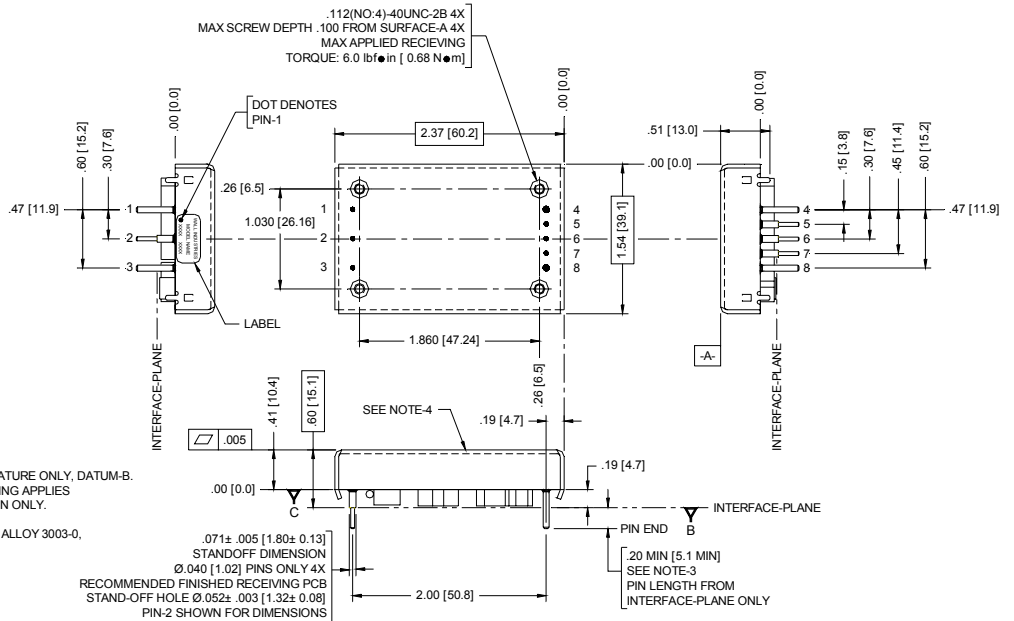

DESIGN CONSIDERATIONS

Under Voltage Lock Out (UVLO)

The converter output is disabled until the input voltage exceeds the UVLO turn-on limit. The converter will remain ON until the input voltage falls below the UVLO turn-off limit.

Over Current Protection

The converter is protected from short circuit and over current conditions. Upon sensing an over current, the output will begin to drop (or 'foldback') limiting the output power. Further increasing the output current will cause the converter to shut off and then restart (or 'hiccup') until the overcurrent condition is removed. Shorting the output will cause the converter to immediately enter the 'hiccup' mode.

Over Temperature Protection

The converter is protected from over temperature conditions. Upon exceeding this temperature, the converter will shut down. The converter will automatically recover once the over temperature condition is removed.

Input Filter

No additional input capacitor is needed for the power supply to operate. However, due to the low voltage, high input current nature of the power supply, it is highly recommended that a minimum 100 uF/50 V electrolytic type input bulk capacitor be added to reduce input ripple voltage and current. Refer to Photos 1 and 2 for an example. For an even further reduction of input ripple, an inductor may be placed between the source and the previously mentioned capacitor. Additionally, a 1-10 uF ceramic capacitor may be added in front of the inductor to form pi-filter. No inductor should be placed between the capacitor and the input to the converter.

Output Filter

No additional output capacitor is needed for the power supply to operate. However, to reduce the ripple and noise on the output, additional capacitance may be added. Usually, a ceramic capacitor between 1 and 100 uF works best for reducing ripple and spike noise. Also, capacitance in the form of a low-esr, surge robust tantalum capacitor (ie: Kemet T495 Series) may also be placed across the output in order reduce ripple, and improve the transient peak-to-peak voltage deviation (see Photos 7 to 11). Due to the low-esr nature of the output of the power supply, adding typical aluminum electrolytic capacitors to the output will not help much in reducing ripple or transient deviations, unless the load is some distance from the power supply output. Then, these capacitors should be placed at the load.

Remote Sense

To improve regulation at the load, route the connections from the -Sense and the +Sense pins to the -Vout and +Vout connections at the load. This will force the converter to regulate the voltage at the load and not at the pins of the converter. If it is not desired to use the Remotes Sense feature, the -Sense and +Sense pins should be shorted to the -Vout and +Vout pins respectively. However, no damage to the converter will occur if the Sense pins are left open.

Fusing

It is required that the input to the converter be supplied with a maximum 10 A, 250 V rated fuse UL Listed or R/C fuse.

Safety

The MPQ24 series is designed to meet EN60950 Safety of Information Technology Equipment. The isolation provided by the MPQ24 series is a Basic insulation in accordance with EN60950. SELV output reliability is maintained only if the input to the converter is a SELV source. To maintain SELV reliability, if either +Vin or -Vin is connected to chassis, either +Vout or -Vout must also be connected to chassis. Otherwise, both the input and the output must not be connected to chassis.

PCB Layout Considerations

Due to the Basic isolation provided by the converter, caution must be observed in routing traces more than 2 mm inward of any input or output pins on the top layer of the pcb board underneath the converter. Also, due to noise coupling and isolation requirements, no power or ground planes or any signal traces should be routed on the top layer of the pcb underneath the converter. Due to comon noise coupling, input or output power and ground planes should not be poured across the input to output on any layers underneath the converter. Instead, it is best to provide separate input and output power and ground traces on the bottom or an inner layer with a minimum of 1 mm separation between traces on the same layer.

Lastly, as the case/heatsink is floating metal, caution must also be observed to provide appropriate spacing (minimum 1.4 mm for Pollution degree 2 Material Group IIIa + IIIb) around the case/heatsink or risk reducing the input to output spacing and violating Basic insulation requirements.

Remote ON/OFF

This converter has the ability to be remotely turned ON or OFF. The series may be ordered Active-High or Active-Low (place an option 'R' at the end of the part number). Active-High means that a logic high at the ENABLE pin will turn ON the supply (Figure 2). With Active-High, if the ENABLE pin is left floating, the supply will be enabled. Active-Low means that a logic low at the ENABLE pin will turn ON the supply (Figure 3). With Active-Low, if the ENABLE pin is left floating, the supply will be disabled. If remote On/Off is not used on an Active-Low supply, short the Enable pin to $-V_{IN}$.

Figure 2: Active High

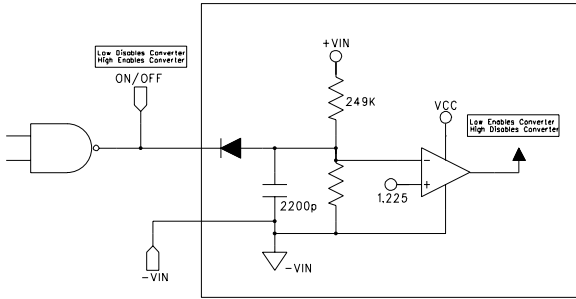
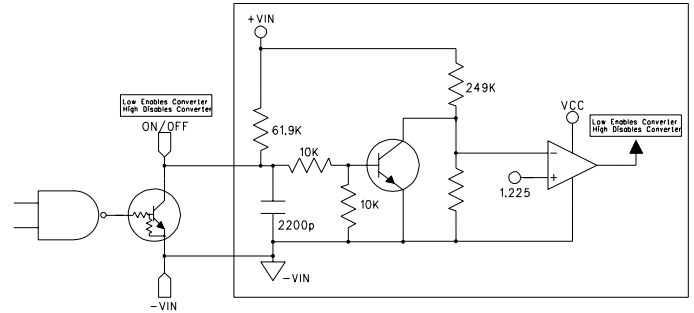

Figure 3: Active Low



Output Voltage Trim

The output is adjustable from $\pm 10\%$ of the output voltage. To adjust the output voltage low, place a resistor between the TRIM and $-SENSE$ pins (Figure 4). To adjust the output voltage high, place a resistor between the $+SENSE$ and TRIM pins (Figure 5). The value of the TRIM resistor with respect to the desired output voltage can be found in Table 2 or derived from the following equations:

$$R_{Trim - Low} = \frac{511}{\Delta\%} - 5.11 \quad (\text{in k}\Omega) \quad R_{Trim - High} = \frac{5.11 \cdot V_{onom} \cdot (\Delta\% + 100)}{2.5 \cdot \Delta\%} - \frac{511}{\Delta\%} - 5.11 \quad (\text{in k}\Omega)$$

$$\text{where } \Delta\% = \text{Percent Trim} = \left| \frac{V_o^{+/-} - V_{onom}}{V_o^{+/-}} \right| \cdot 100$$

FIGURE 4: TRIM LOW

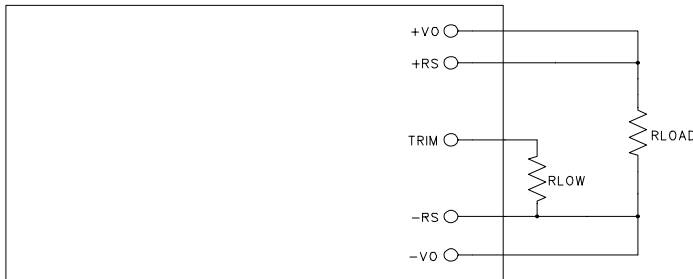
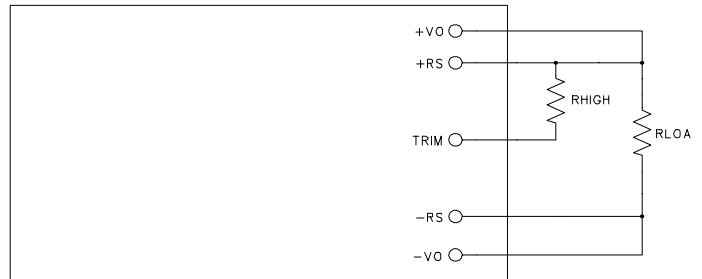

FIGURE 5: TRIM HIGH



NOTE 1: CONNECT TRIM RESISTOR AS CLOSE TO CONVERTER PINS AS POSSIBLE

Table 2: Trim Resistor Values (in k Ω)

Percent Trim	TRIM Low		TRIM High	
	Vout	R _{Low}	Vout	R _{High}
1%	4.950	500.78	5.050	511.00
2%	4.900	245.28	5.100	255.50
3%	4.850	160.11	5.150	170.33
4%	4.800	117.53	5.200	127.75
5%	4.750	91.98	5.250	102.20
6%	4.700	74.95	5.300	85.17
7%	4.650	62.78	5.350	73.00
8%	4.600	53.66	5.400	63.88
9%	4.550	46.56	5.450	56.78
10%	4.500	40.88	5.500	51.10

Note 2: While decreasing the output voltage, the maximum output current remains the same, and while increasing the output voltage, the output current is reduced to maintain the total output power at 50 W.

Graph 1: MPQ24S5-50 Efficiency vs. Output Current

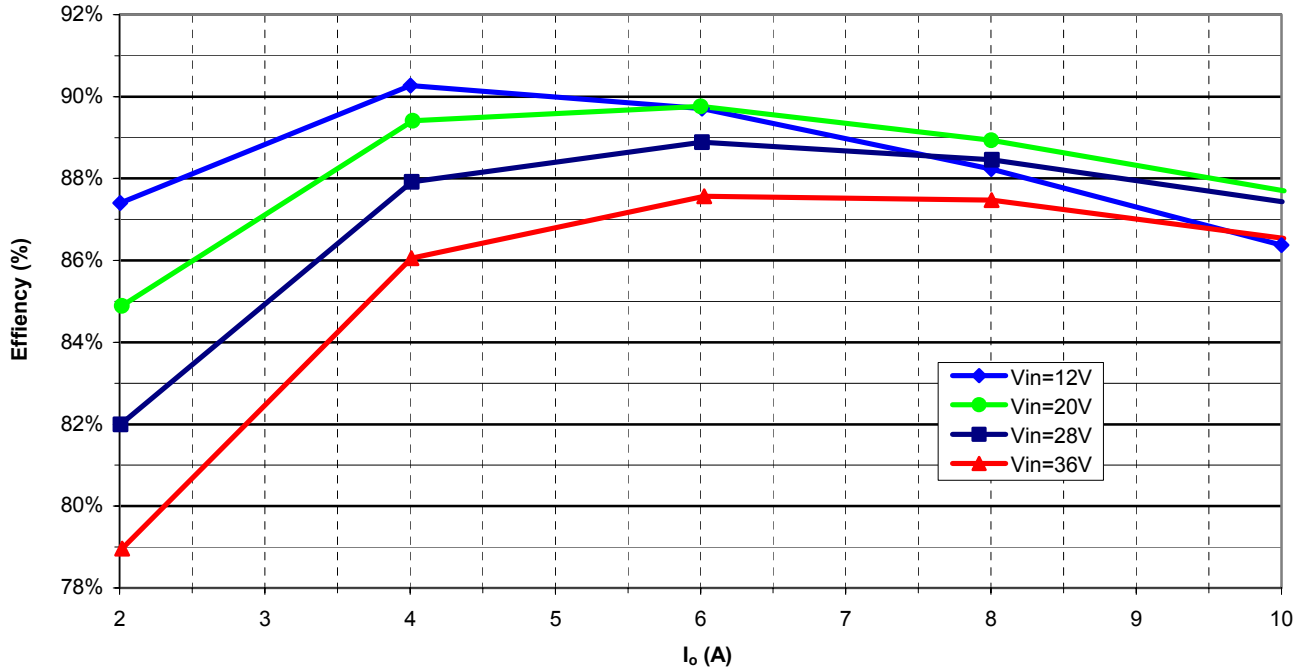

Graph 2: MPQ24S5-50 Max Ambient vs. Io

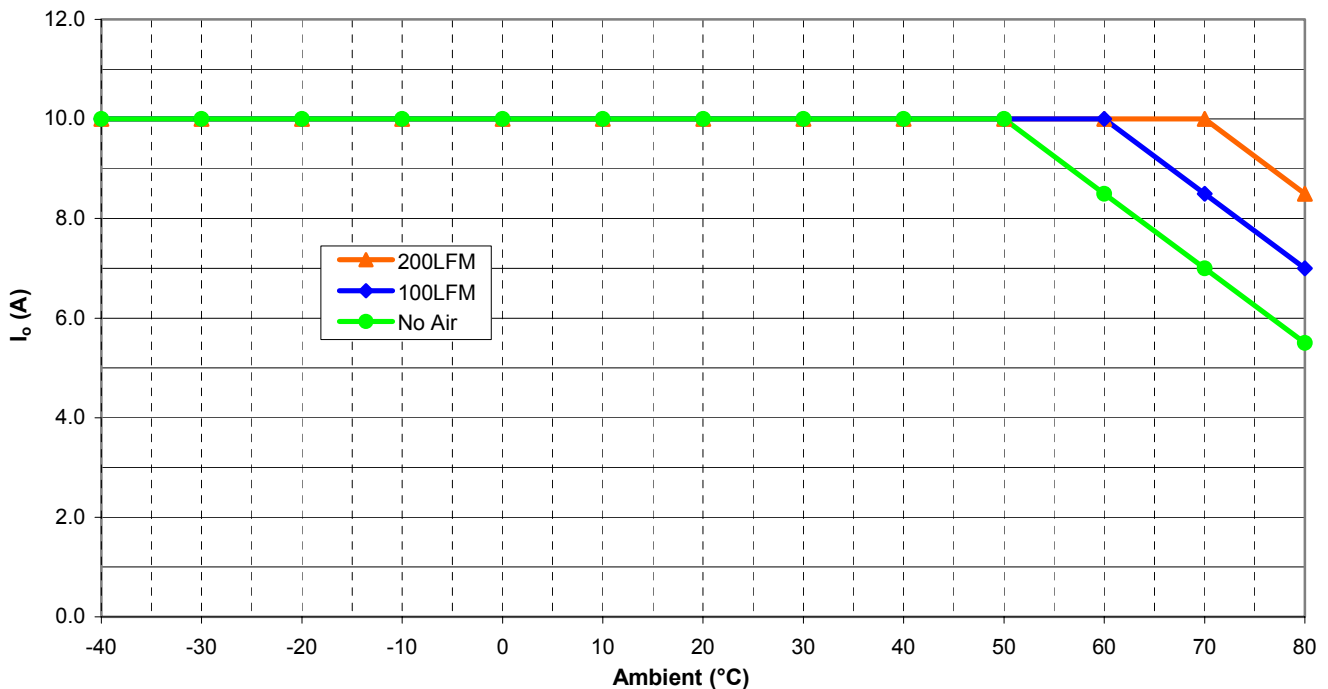

Note 3: When trimming output high, I_o vs. Ambient is derated by power. ie: from Graph 2, find the maximum current at the desired ambient and airflow, and multiply this current by the nominal voltage to get the maximum power. Divide this power by the desired trimmed high voltage to get the maximum current at that ambient. When trimming low, the maximum current stays the same as shown in Graph 2.

Graph 3: MPQ24S5-50 Input Current vs. Input Voltage

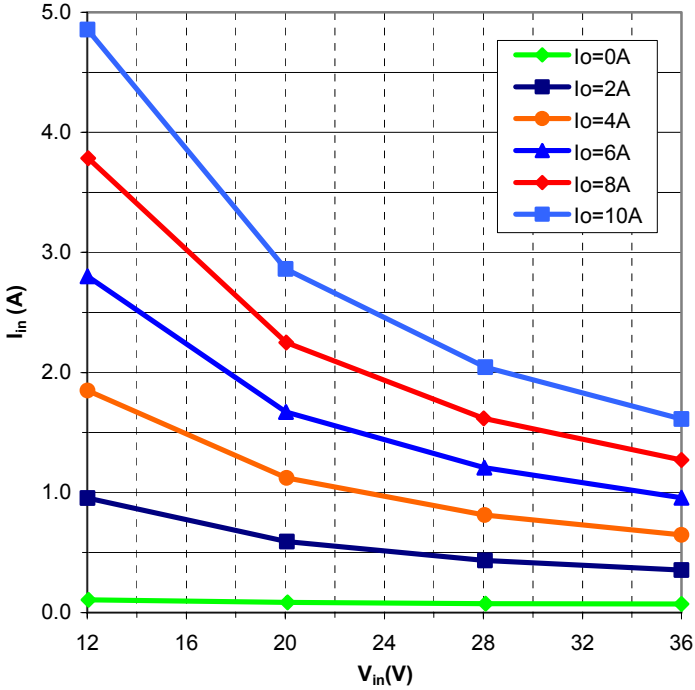

Graph 4: MPQ24S5-50 Power Dissipation vs. Input Voltage

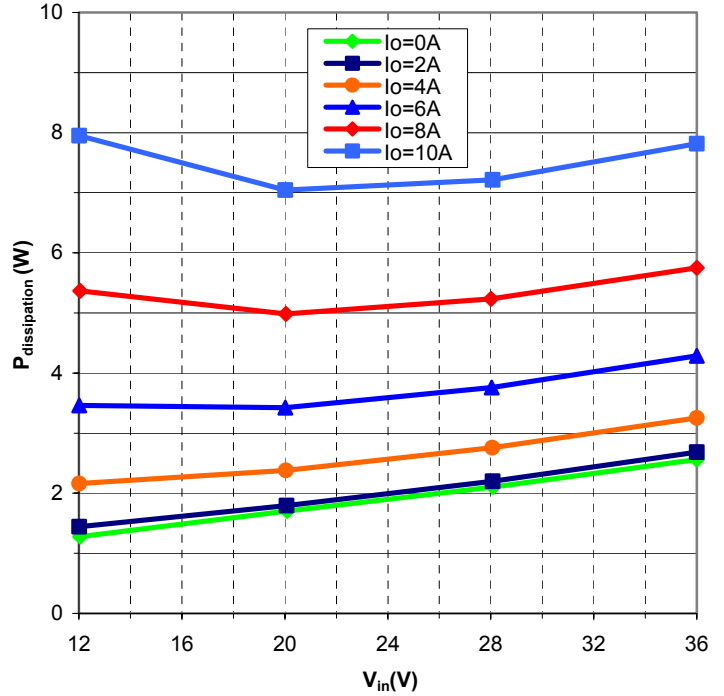

Graph 5: MPQ24S5-50 No Load Input Current and Power Dissipation vs. Input Voltage

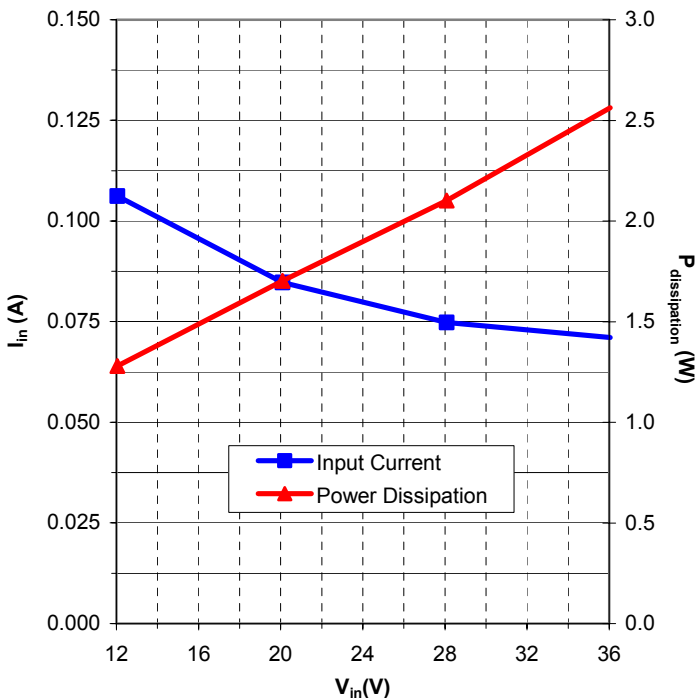

Graph 6: MPQ24S5-50 "Remote Off" Input Current and Power Dissipation vs. Input Voltage

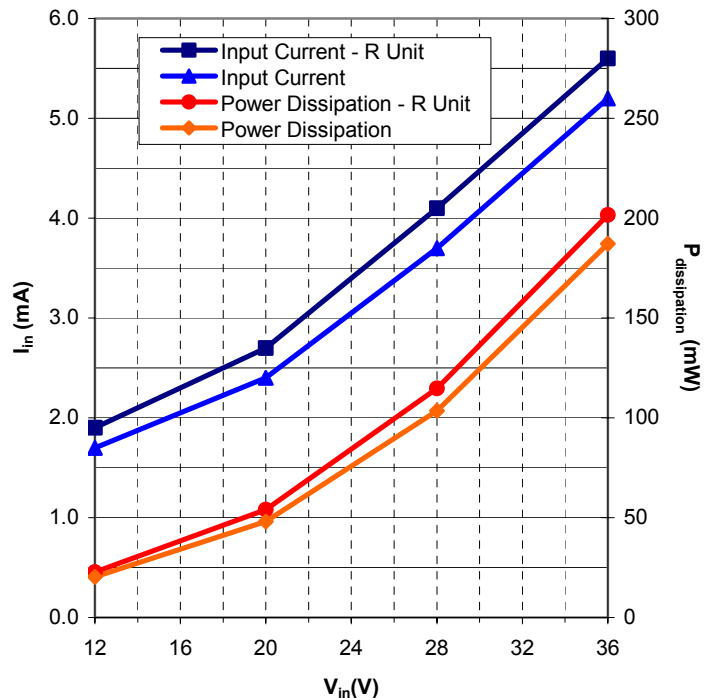

Note 4: Voltage measurements taken where the output pins are soldered into test board.

Graph 7: MPQ24S5-50 Load Regulation
(+SENSE to +Vout, -SENSE to -Vout)

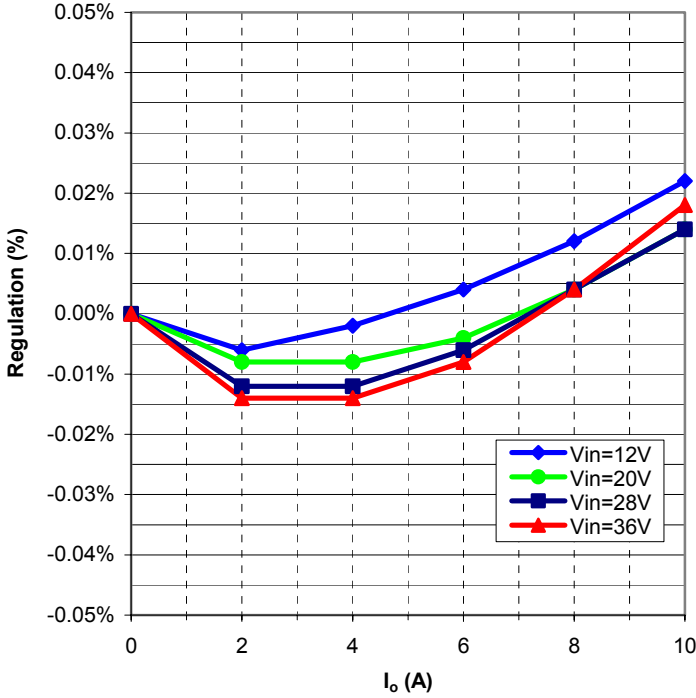

Graph 8: MPQ24S5-50 Line Regulation
(+SENSE to +Vout, -SENSE to -Vout)

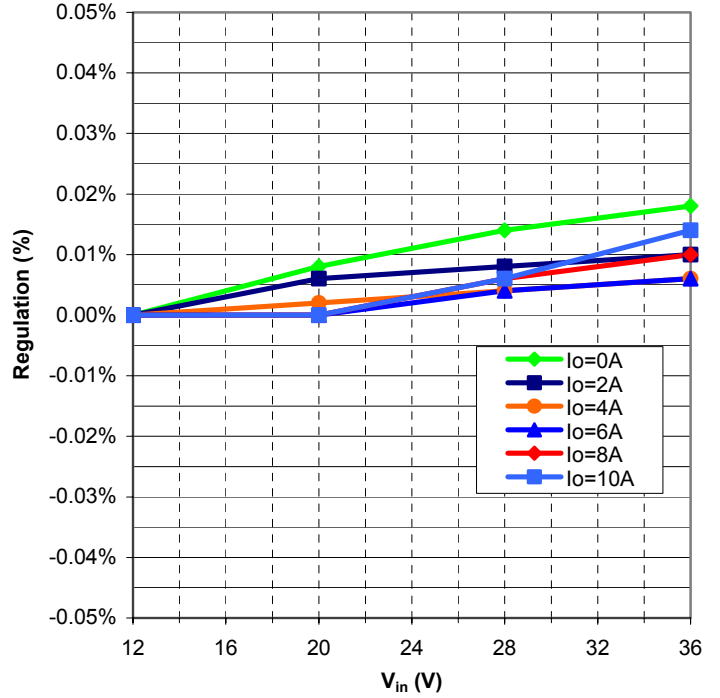

Graph 9: MPQ24S5-50 Output Temperature Drift
(+SENSE to +Vout, -SENSE to -Vout)

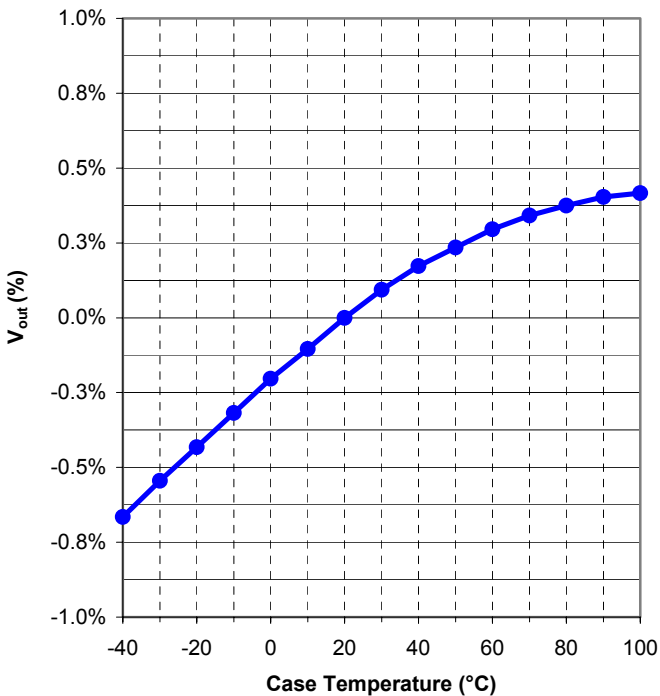

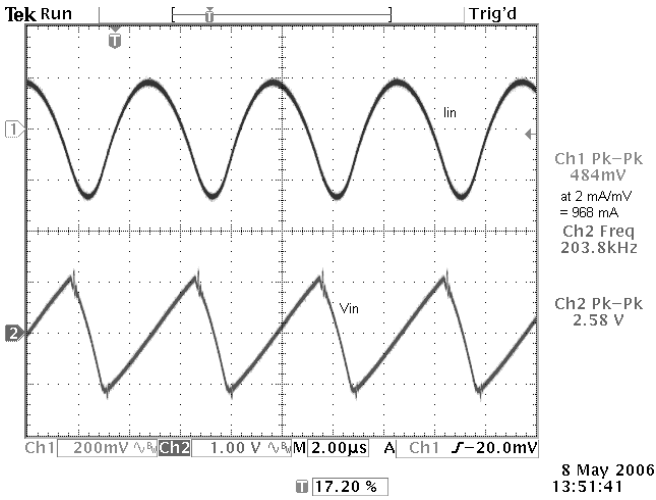

Photo 1: Input Ripple Voltage and Current
 $V_{in}=24\text{ V}$, $I_{out} = 10\text{ A}$

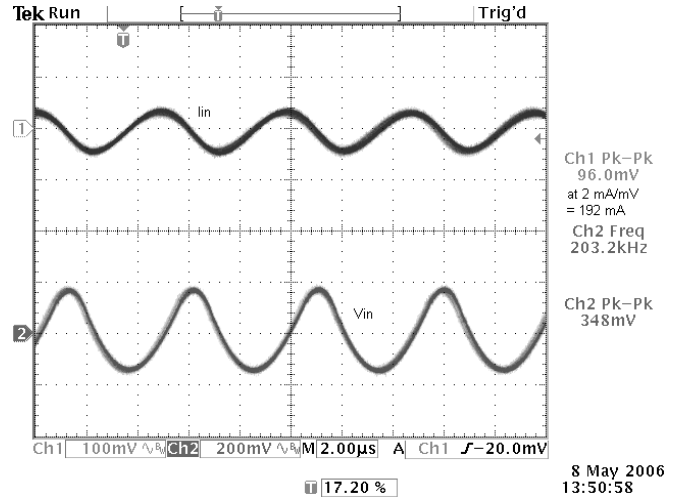

Photo 2: Input Ripple Voltage and Current
 $V_{in}=24\text{ V}$, $I_{out} = 10\text{ A}$
With a 120 μF Aluminum Electrolytic across the Input

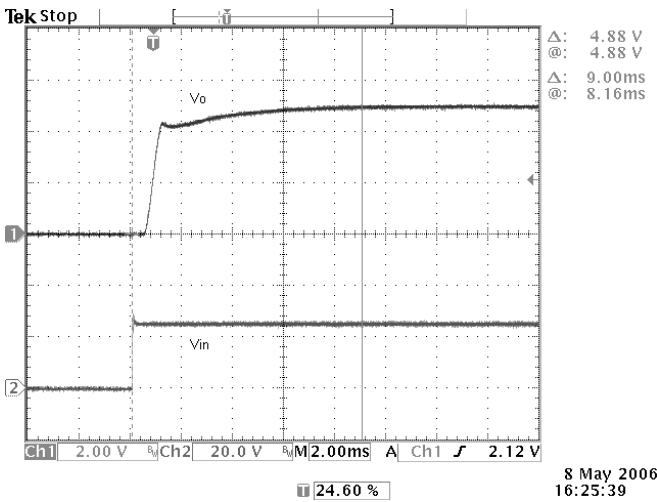

Photo 3: Normal Turn On at 24 V

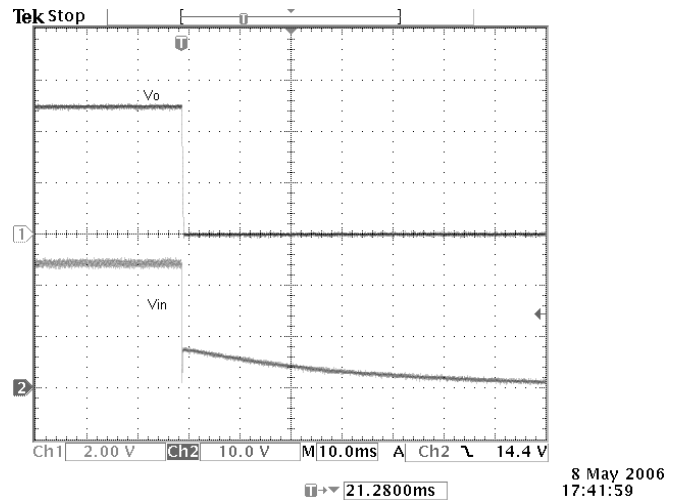

Photo 4: Normal Turn Off at 24 V

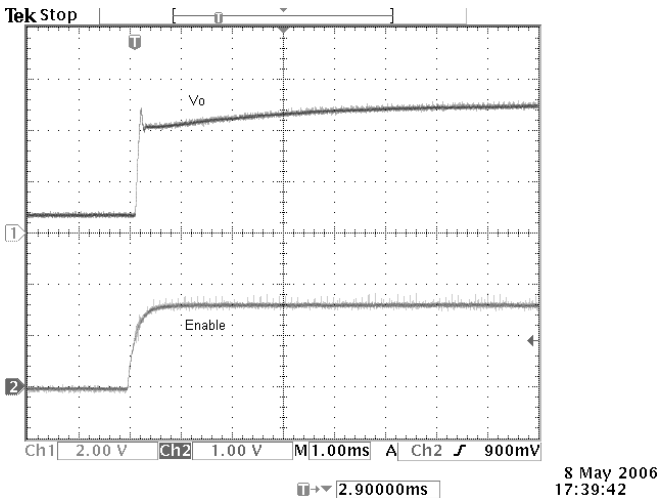

Photo 5: Turn On by Enable at 24 V

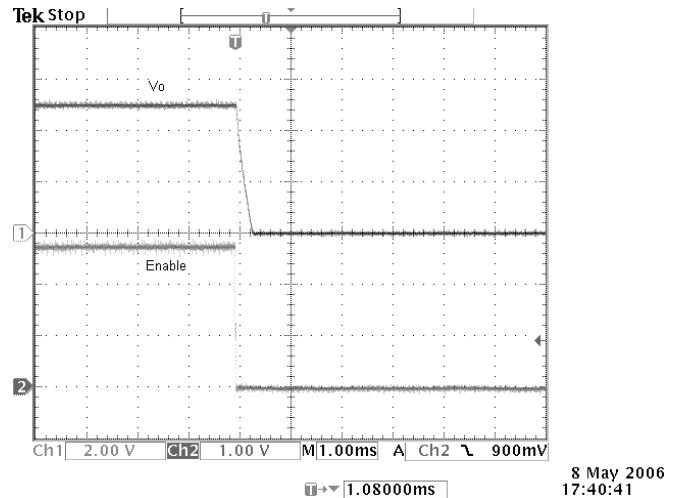

Photo 6: Turn Off by Enable at 24 V

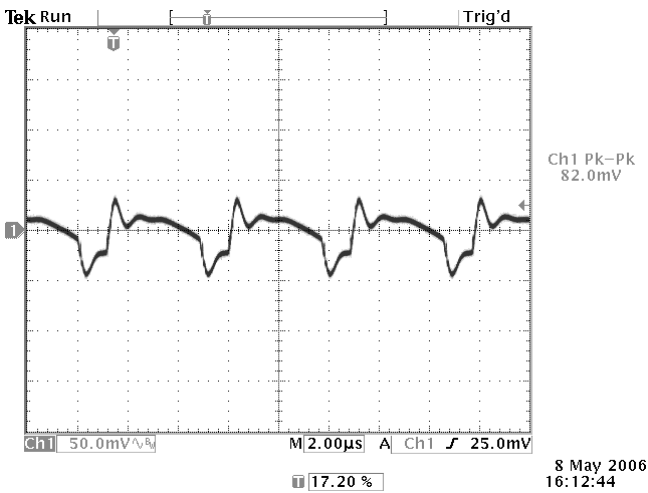

Photo 7: Output Ripple and Noise (20 MHz BW)
 $V_{in}=24\text{ V}$, $I_{out} = 10\text{ A}$

With a 1 μF Ceramic & a 10 μF Tantalum across the Output

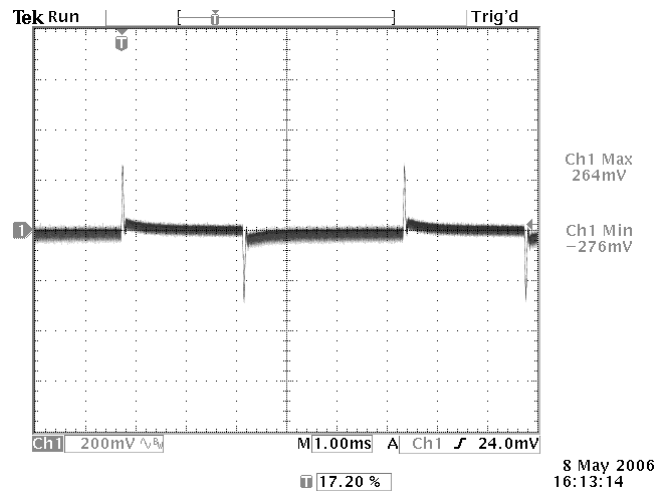

Photo 8: Transient Response – 0.25A/us
 $V_{in}=24\text{ V}$, $I_{out} = 2.5\text{ to }7.5\text{ A}$ (25% to 100%)

With a 1 μF Ceramic & a 10 μF Tantalum across the Output

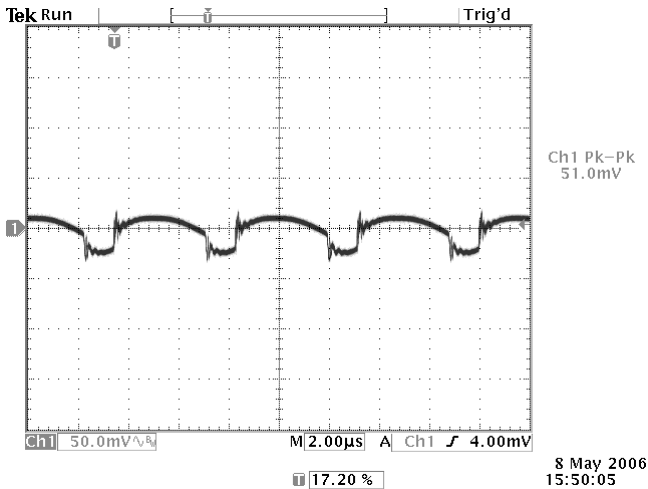

Photo 9: Output Ripple and Noise (20 MHz BW)
 $V_{in}=24\text{ V}$, $I_{out} = 10\text{ A}$

With a 330 μF Tantalum across the Output

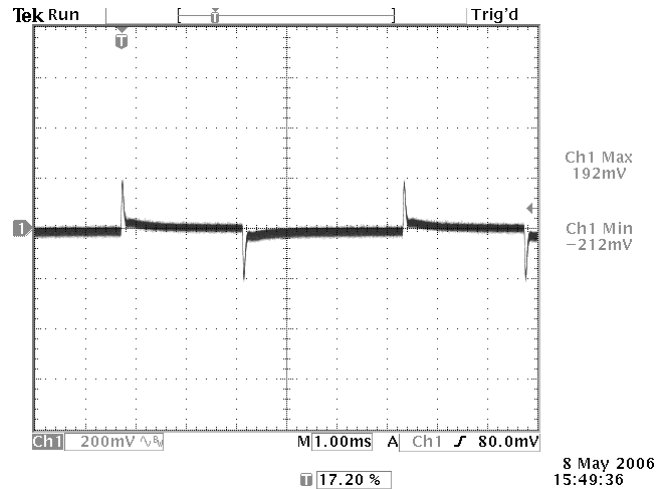

Photo 10: Transient Response – 0.25A/us
 $V_{in}=24\text{ V}$, $I_{out} = 2.5\text{ to }7.5\text{ A}$ (25% to 100%)

With a 330 μF Tantalum across the Output

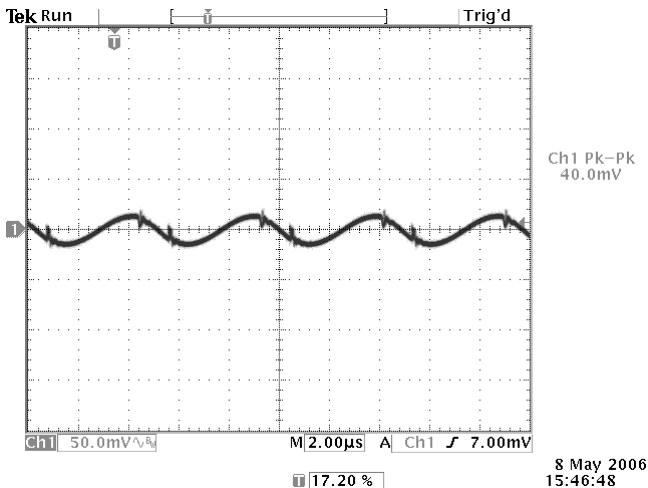

Photo 10: Output Ripple and Noise (20 MHz BW)
 $V_{in}=24\text{ V}$, $I_{out} = 10\text{ A}$

With a 100 μF Ceramic across the Output

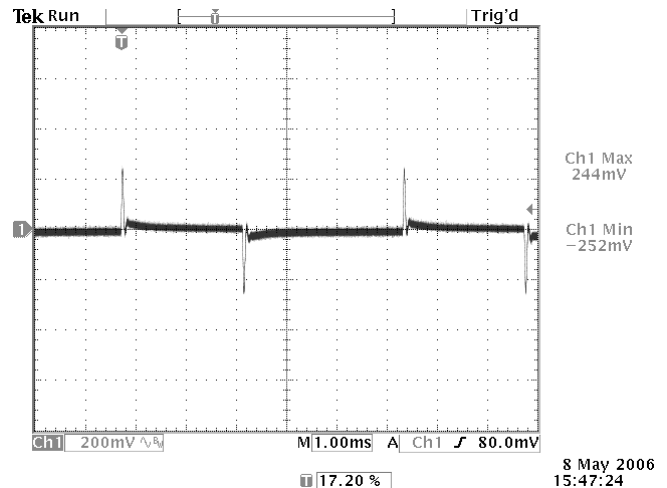

Photo 11: Transient Response – 0.25A/us
 $V_{in}=24\text{ V}$, $I_{out} = 2.5\text{ to }7.5\text{ A}$ (25% to 100%)

With a 100 μF Ceramic across the Output

Ordering Information:

Part Number Example:

MPQ 24 S 48 - 50 R

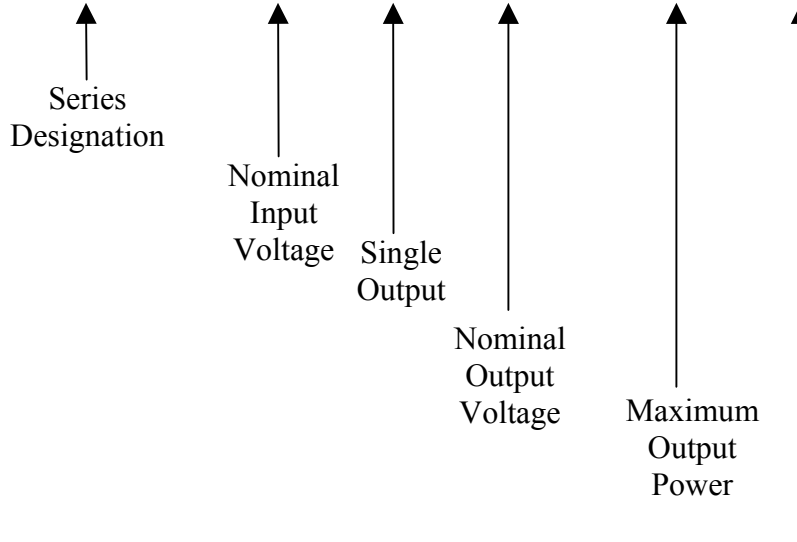

Options	
	Leave Blank for no Options
R	Active Low
C	Heatsink/Case

Company Information:

Wall Industries, Inc. has created custom and modified units for over 40 years. Our in-house research and development engineers will provide a solution that exceeds your performance requirements on-time and on budget. Our ISO9001-2000 certification is just one example of our commitment to producing a high quality, well documented product for our customers.

Our past projects demonstrate our commitment to you, our customer. Wall Industries, Inc. has a reputation for working closely with it's customers to ensure each solution meets or exceeds form, fit and function requirements. We will continue to provide ongoing support for your project above and beyond the design and production phases. Give us a call today to discuss your future projects.

Contact **Wall Industries** for further information:

Phone: ☎ (603)778-2300
Toll Free: ☎ (888)587-9255
Fax: ☎ (603)778-9797
E-mail: sales@wallindustries.com
Web: www.wallindustries.com
Address: 5 Watson Brook Rd.
Exeter, NH 03833