

To all our customers

---

## **Regarding the change of names mentioned in the document, such as Hitachi Electric and Hitachi XX, to Renesas Technology Corp.**

---

The semiconductor operations of Mitsubishi Electric and Hitachi were transferred to Renesas Technology Corporation on April 1st 2003. These operations include microcomputer, logic, analog and discrete devices, and memory chips other than DRAMs (flash memory, SRAMs etc.) Accordingly, although Hitachi, Hitachi, Ltd., Hitachi Semiconductors, and other Hitachi brand names are mentioned in the document, these names have in fact all been changed to Renesas Technology Corp. Thank you for your understanding. Except for our corporate trademark, logo and corporate statement, no changes whatsoever have been made to the contents of the document, and these changes do not constitute any alteration to the contents of the document itself.

Renesas Technology Home Page: <http://www.renesas.com>

Renesas Technology Corp.  
Customer Support Dept.  
April 1, 2003

## Cautions

Keep safety first in your circuit designs!

1. Renesas Technology Corporation puts the maximum effort into making semiconductor products better and more reliable, but there is always the possibility that trouble may occur with them. Trouble with semiconductors may lead to personal injury, fire or property damage.

Remember to give due consideration to safety when making your circuit designs, with appropriate measures such as (i) placement of substitutive, auxiliary circuits, (ii) use of nonflammable material or (iii) prevention against any malfunction or mishap.

Notes regarding these materials

1. These materials are intended as a reference to assist our customers in the selection of the Renesas Technology Corporation product best suited to the customer's application; they do not convey any license under any intellectual property rights, or any other rights, belonging to Renesas Technology Corporation or a third party.
2. Renesas Technology Corporation assumes no responsibility for any damage, or infringement of any third-party's rights, originating in the use of any product data, diagrams, charts, programs, algorithms, or circuit application examples contained in these materials.
3. All information contained in these materials, including product data, diagrams, charts, programs and algorithms represents information on products at the time of publication of these materials, and are subject to change by Renesas Technology Corporation without notice due to product improvements or other reasons. It is therefore recommended that customers contact Renesas Technology Corporation or an authorized Renesas Technology Corporation product distributor for the latest product information before purchasing a product listed herein.  
The information described here may contain technical inaccuracies or typographical errors. Renesas Technology Corporation assumes no responsibility for any damage, liability, or other loss rising from these inaccuracies or errors.  
Please also pay attention to information published by Renesas Technology Corporation by various means, including the Renesas Technology Corporation Semiconductor home page (<http://www.renesas.com>).
4. When using any or all of the information contained in these materials, including product data, diagrams, charts, programs, and algorithms, please be sure to evaluate all information as a total system before making a final decision on the applicability of the information and products. Renesas Technology Corporation assumes no responsibility for any damage, liability or other loss resulting from the information contained herein.
5. Renesas Technology Corporation semiconductors are not designed or manufactured for use in a device or system that is used under circumstances in which human life is potentially at stake. Please contact Renesas Technology Corporation or an authorized Renesas Technology Corporation product distributor when considering the use of a product contained herein for any specific purposes, such as apparatus or systems for transportation, vehicular, medical, aerospace, nuclear, or undersea repeater use.
6. The prior written approval of Renesas Technology Corporation is necessary to reprint or reproduce in whole or in part these materials.
7. If these products or technologies are subject to the Japanese export control restrictions, they must be exported under a license from the Japanese government and cannot be imported into a country other than the approved destination.  
Any diversion or reexport contrary to the export control laws and regulations of Japan and/or the country of destination is prohibited.
8. Please contact Renesas Technology Corporation for further details on these materials or the products contained therein.

# 2SC1881(K)

Silicon NPN Triple Diffused

RENESAS

ADE-208-882 (Z)

1st. Edition

September 2000

## Application

High gain amplifier power switching

## Outline

TO-220AB

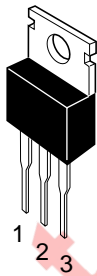

1. Base
2. Collector (Flange)
3. Emitter

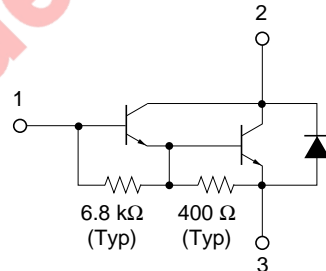

## Absolute Maximum Ratings (T<sub>a</sub> = 25°C)

Item	Symbol	Ratings	Unit
Collector to base voltage	V <sub>CBO</sub>	60	V
Collector to emitter voltage	V <sub>CEO</sub>	60	V
Emitter to base voltage	V <sub>EBO</sub>	7	V
Collector current	I <sub>C</sub>	3	A
Collector peak current	I <sub>C(peak)</sub>	6	A
Collector power dissipation	P <sub>C</sub> <sup>*1</sup>	30	W
Junction temperature	T <sub>j</sub>	150	°C
Storage temperature	T <sub>stg</sub>	-55 to +150	°C

Note: 1. Value at T<sub>c</sub> = 25°C.

## Electrical Characteristics (Ta = 25°C)

Item	Symbol	Min	Typ	Max	Unit	Test conditions
Collector to emitter breakdown voltage	$V_{(BR)CEO}$	60	—	—	V	$I_C = 50 \text{ mA}$ , $R_{BE} = \infty$
Emitter to base breakdown voltage	$V_{(BR)EBO}$	7	—	—	V	$I_E = 50 \text{ mA}$ , $I_C = 0$
Collector cutoff current	$I_{CBO}$	—	—	0.2	mA	$V_{CB} = 60 \text{ V}$ , $I_E = 0$
	$I_{CEO}$	—	—	0.4	mA	$V_{CE} = 30 \text{ V}$ , $R_{BE} = \infty$
DC current transfer ratio	$h_{FE}$	1000	—	—		$V_{CE} = 1.5 \text{ V}$ $I_C = 1.5 \text{ A}^{*1}$
		500	—	—		$I_C = 2.5 \text{ A}^{*1}$
Collector to emitter saturation voltage	$V_{CE(sat)}$	—	—	1.2	V	$I_C = 2.5 \text{ A}$ , $I_B = 20 \text{ mA}^{*1}$
Turn on time	$t_{on}$	—	1	—	$\mu\text{s}$	$V_{CC} = 11 \text{ V}$ , $I_C = 2 \text{ A}$ ,
Turn off time	$t_{off}$	—	5	—	$\mu\text{s}$	$I_{B1} = -I_{B2} = 8 \text{ mA}$

Note: 1. Pulse test.

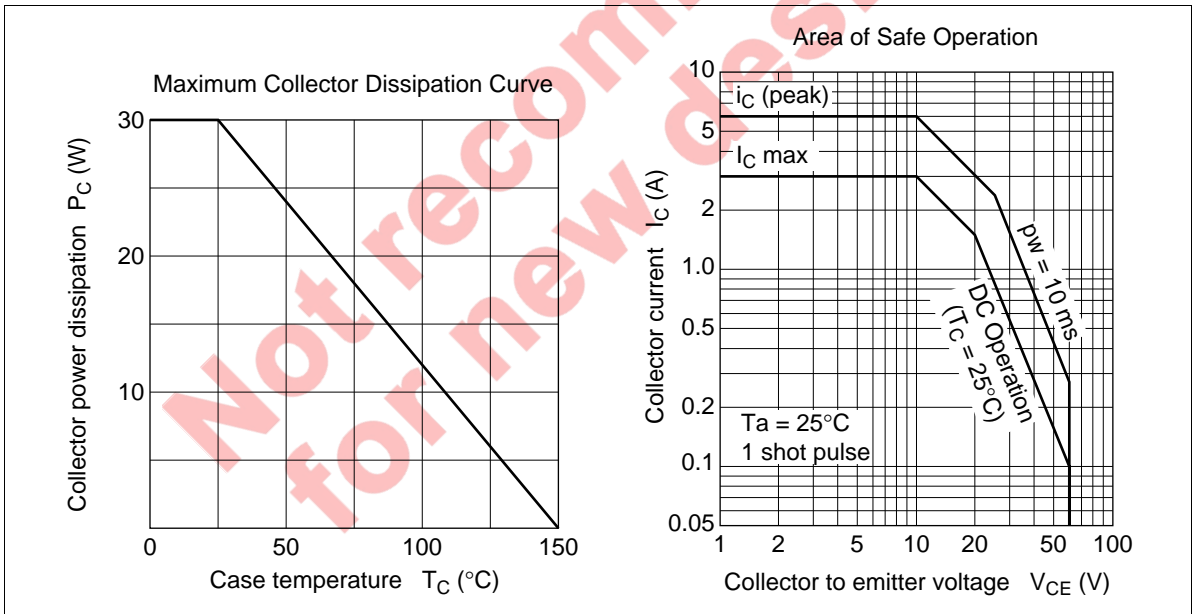

Typical Output Characteristics

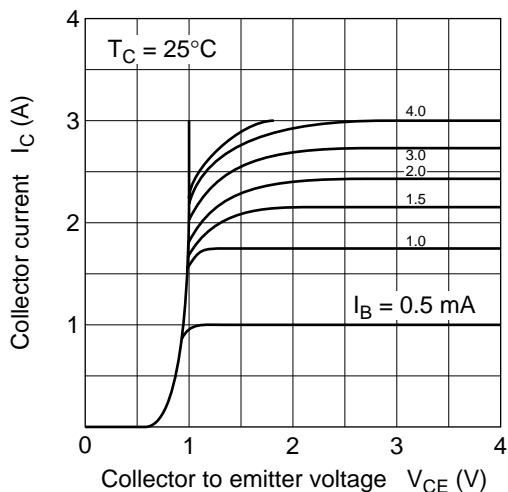

DC Current Transfer Ratio vs. Collector Current

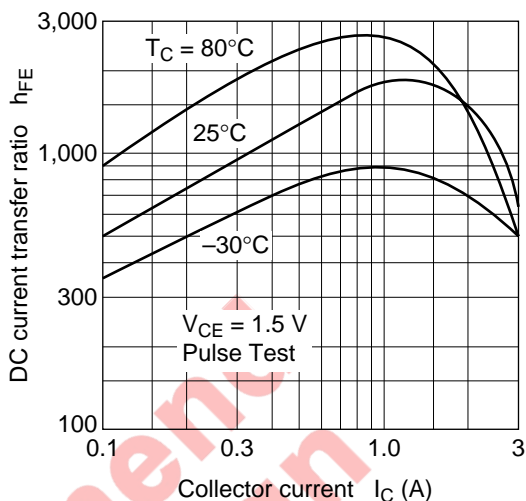

Collector to Emitter Saturation Voltage vs. Collector Current

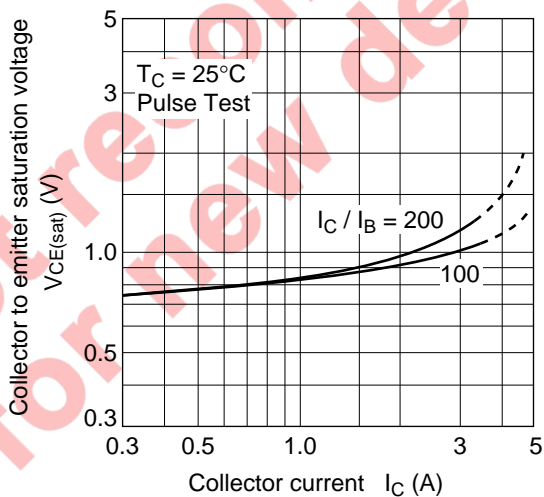

Switching Time Test Circuit

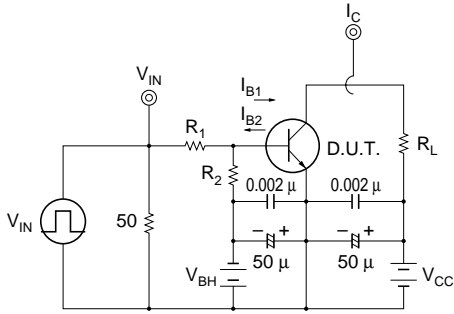

$t_r, t_f \leq 10 \text{ ns}$   
 $\text{pw} \geq 100 \mu\text{s}$   
 duty ratio  $\leq 10\%$

Unit R :  $\Omega$   
 C : F

Response Waveform

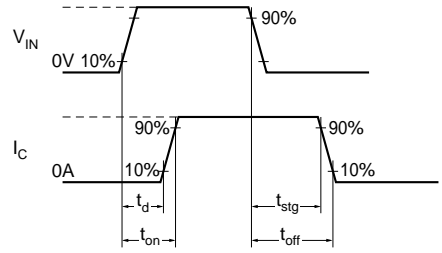

$I_C$	$I_{B1}$	$I_{B2}$	$V_{CC}$	$V_{BB}$	$V_{IN}$	$R_L$	$R_1$	$R_2$
A	mA	mA	V	V	V	$\Omega$	$\Omega$	$\Omega$
2	8	-8	11	-4	7.2	5	620	910

Not recommend  
for new design

When using this document, keep the following in mind:

1. This document may, wholly or partially, be subject to change without notice.
2. All rights are reserved: No one is permitted to reproduce or duplicate, in any form, the whole or part of this document without Hitachi's permission.
3. Hitachi will not be held responsible for any damage to the user that may result from accidents or any other reasons during operation of the user's unit according to this document.
4. Circuitry and other examples described herein are meant merely to indicate the characteristics and performance of Hitachi's semiconductor products. Hitachi assumes no responsibility for any intellectual property claims or other problems that may result from applications based on the examples described herein.
5. No license is granted by implication or otherwise under any patents or other rights of any third party or Hitachi, Ltd.
6. **MEDICAL APPLICATIONS:** Hitachi's products are not authorized for use in **MEDICAL APPLICATIONS** without the written consent of the appropriate officer of Hitachi's sales company. Such use includes, but is not limited to, use in life support systems. Buyers of Hitachi's products are requested to notify the relevant Hitachi sales offices when planning to use the products in **MEDICAL APPLICATIONS**.

# HITACHI

## Hitachi, Ltd.

Semiconductor & IC Div.  
Nippon Bldg., 2-6-2, Ohte-machi, Chiyoda-ku, Tokyo 100, Japan  
Tel: Tokyo (03) 3270-2111  
Fax: (03) 3270-5109

### For further information write to:

Hitachi America, Ltd.  
Semiconductor & IC Div.  
2000 Sierra Point Parkway  
Brisbane, CA. 94005-1835  
U S A  
Tel: 415-589-8300  
Fax: 415-583-4207

Hitachi Europe GmbH  
Electronic Components Group  
Continental Europe  
Domacher Straße 3  
D-85622 Feldkirchen  
München  
Tel: 089-9 91 80-0  
Fax: 089-9 29 30 00

Hitachi Europe Ltd.  
Electronic Components Div.  
Northern Europe Headquarters  
Whitebrook Park  
Lower Cookham Road  
Maidenhead  
Berkshire SL6 8YA  
United Kingdom  
Tel: 0628-585000  
Fax: 0628-778322

Hitachi Asia Pte. Ltd.  
16 Collyer Quay #20-00  
Hitachi Tower  
Singapore 0104  
Tel: 535-2100  
Fax: 535-1533

Hitachi Asia (Hong Kong) Ltd.  
Unit 706, North Tower,  
World Finance Centre,  
Harbour City, Canton Road  
Tsim Sha Tsui, Kowloon  
Hong Kong  
Tel: 27359218  
Fax: 27306071