

● Features:

- * Non-contact switching.
- * For direct pc board or dual-in-line socket mounting.
- * Fast switching speed.
- * This product doesn't contain restriction substance, comply ROHS standard.

● Package Dimensions

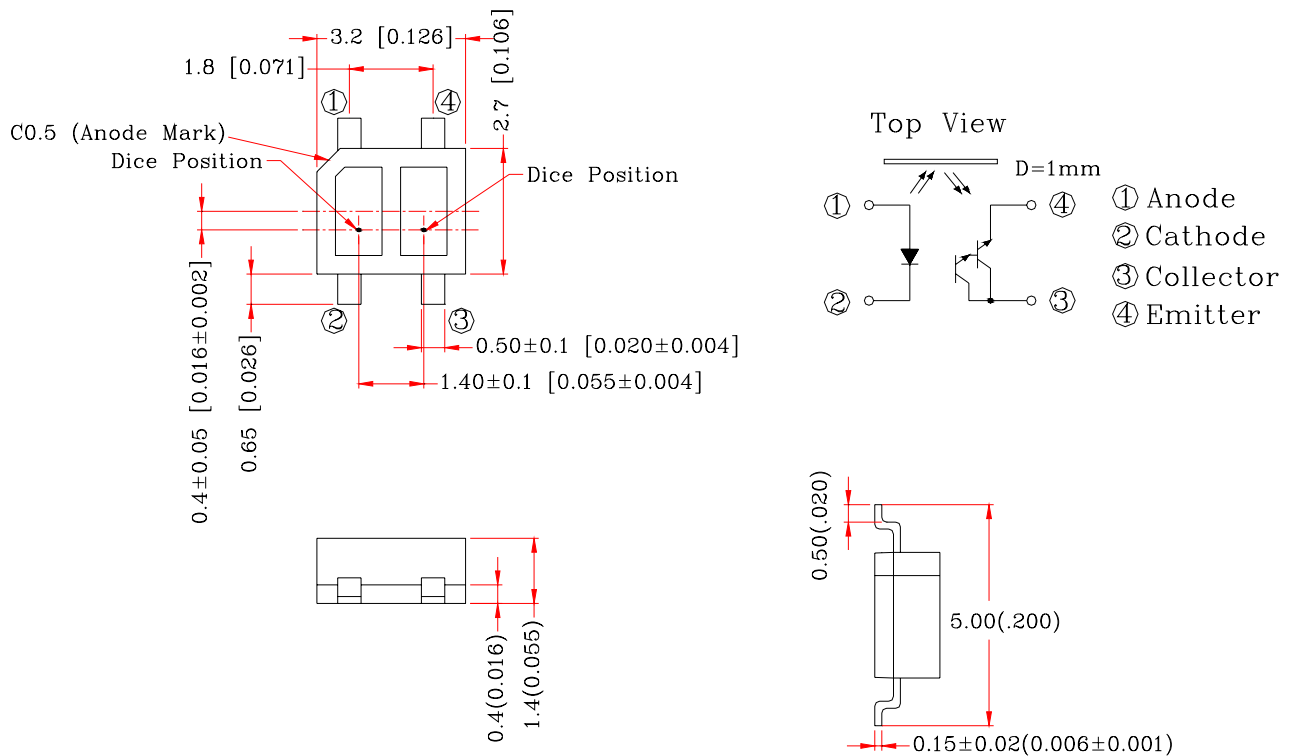

Notes:

1. All dimensions are in millimeters (inches).
2. Tolerance is ±0.25mm unless otherwise specified.
3. Lead spacing is measured where the leads emerge from the package.
4. Specifications are subject to change without notice.

● **Absolute Maximum Rating (Ta=25°C)**

Item		Symbol	Rating	Unit
Input	Power Dissipation	Pd	75	mW
	Reverse Voltage	V _R	5	V
	Forward Current	I _F	50	mA
	Peak Forward Current (*1)	I _{FP}	1	A
Output	Collector Power Dissipation	P _C	100	mW
	Collector Current	I _C	20	mA
	C-E Voltage	V _{CEO}	30	V
	E-C Voltage	V _{ECO}	5	V
Operating Temperature		Topr	-25 ~ +85	°C
Storage Temperature		Tstg	-40 ~ +100	°C
Soldering Temperature (*2)		Tsol	260	°C

(*1) tw=100 μSec. 、T=10 mSec.

(*2) t=3 Sec

● **Electrical Optical Characteristics (Ta=25°C)**

Parameter		Symbol	Condition	Min.	Typ.	Max.	Unit	BIN No.
Input	Forward Voltage	V _F	I _F =20mA	—	1.2	1.5	V	
	Reverse Current	I _R	V _R =5V	—	—	100	μA	
	Peak Wavelength	λ _p	I _F =10mA		940		nm	
Output	Dark Current	I _D	V _{CE} =10V	—	—	200	nA	
	C-E Saturation Voltage	V _{CE(sat)}	I _C =0.25mA I _F =10mA	—	—	0.4	V	
Light Current		I _L	V _{CE} =5V I _F =10mA D=1.0mm (90% Reflective white paper)	80	—	240	μA	BIN A
				160	—	480		BIN B
				320	—	960		BIN C
				640	—	1920		BIN D
Speed	Rise Time	Tr	I _{FP} =20mA V _{CE} =5V	—	20	—	μsec	
	Fall Time	Tf	R _L =1000Ω	—	20	—	μsec	

● Typical Electrical / Optical Characteristics Curves (Ta=2°C)

Fig.1 Power Dissipation vs. Ambient Temperature

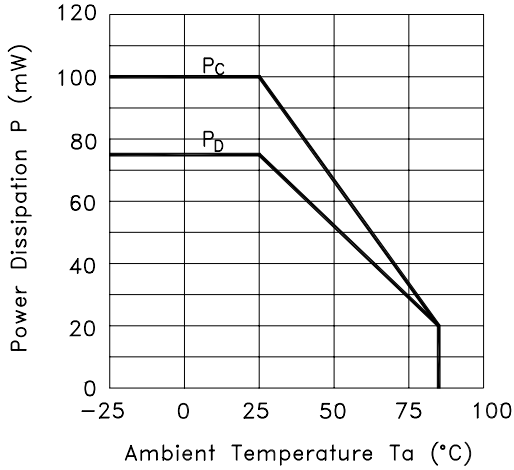

Fig.2 Forward Current vs. Forward Voltage

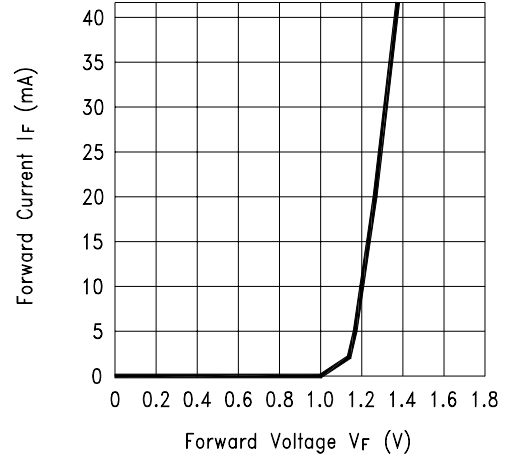

Fig.3 Collector Current vs. Collector-emitter Voltage

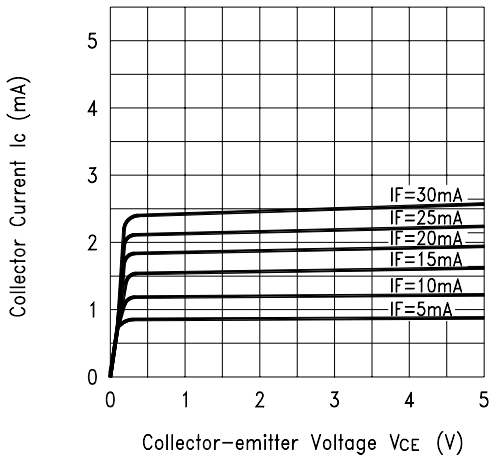
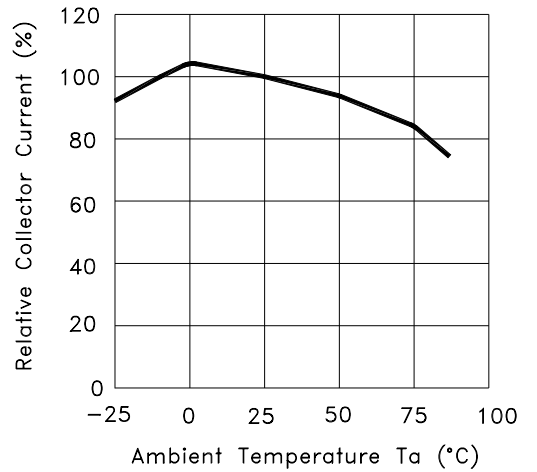

Fig.4 Collector Current vs. Ambient Temperature



● Typical Electrical / Optical Characteristics Curves (Ta=25°C)

Fig.5 Collector-emitter Saturation Voltage vs. Ambient Temperature

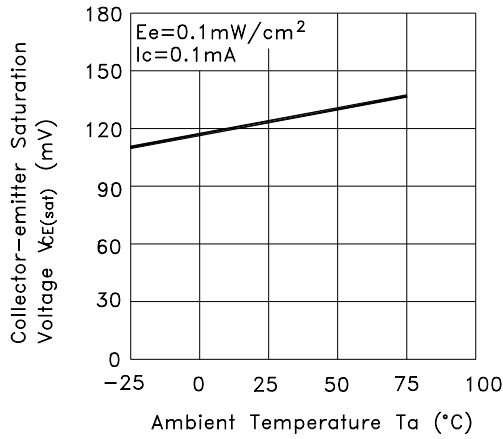

Fig.6 Response Time vs. Load Resistance

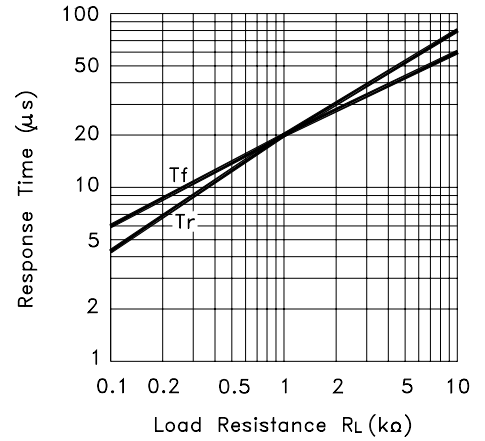
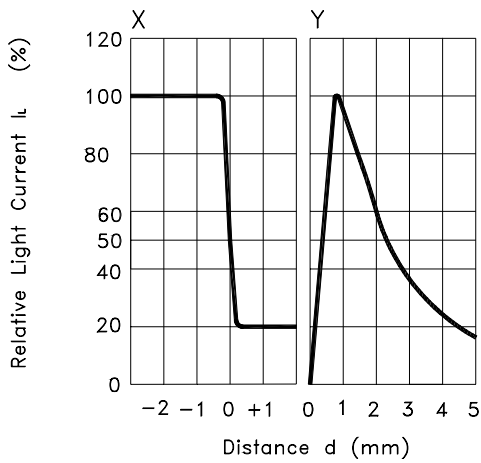
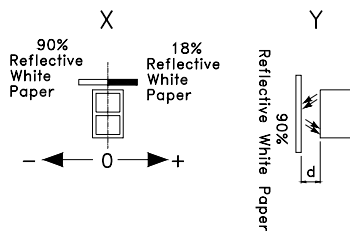

Fig.7 Sensing Position Characteristics (Typical)



(Center of Optical axis)



Test Circuit for Response Time

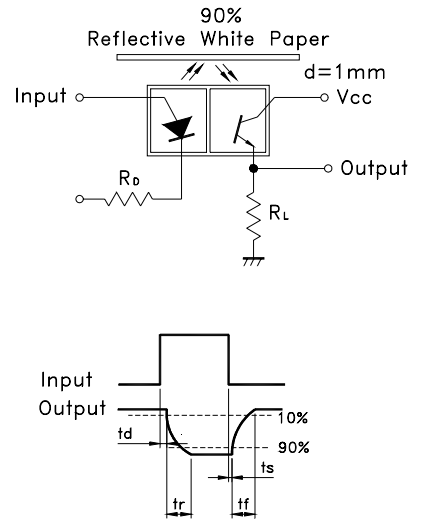

● Packaging Box Dimensions

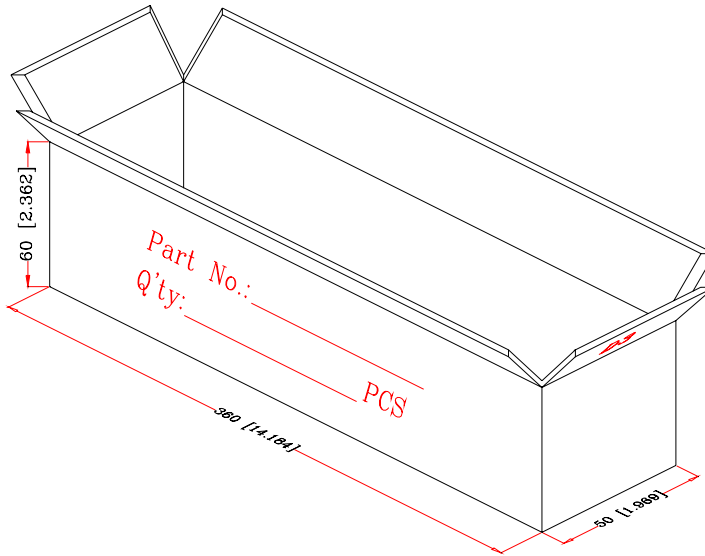

● Packaging Tube Dimensions

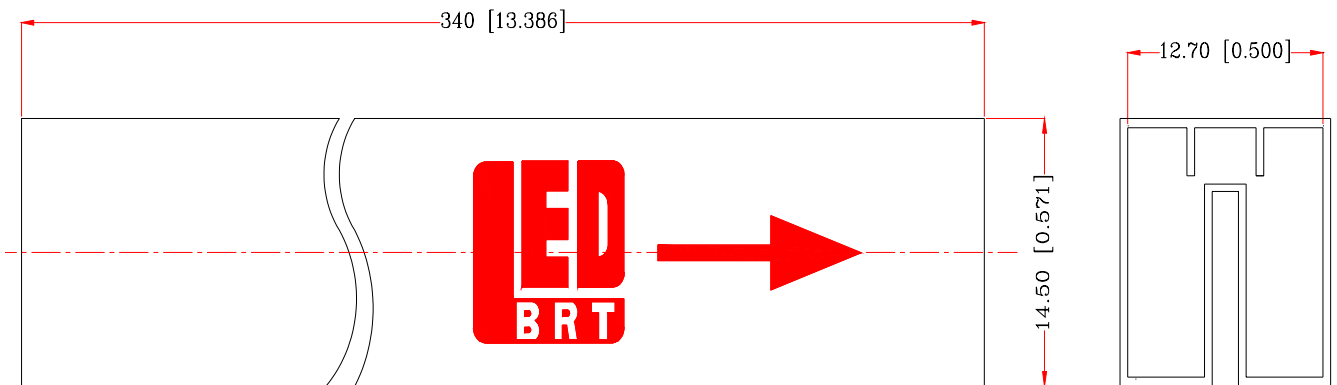

Notes:

1. 100pcs per tube, 5kpcs per box
2. All Dimensions are in millimeters (inches).
3. Specifications are subject to change without notice.