

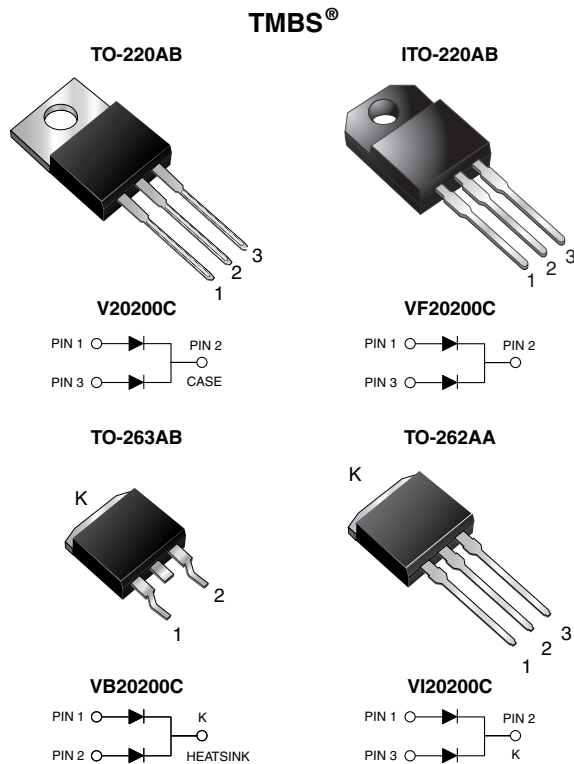

Dual High-Voltage Trench MOS Barrier Schottky Rectifier

Ultra Low $V_F = 0.60\text{ V}$ at $I_F = 5\text{ A}$



FEATURES

- Trench MOS Schottky technology
- Low forward voltage drop, low power losses
- High efficiency operation
- Low thermal resistance
- Meets MSL level 1, per J-STD-020, LF maximum peak of 245 °C (for TO-263AB package)
- Solder dip 260 °C, 40 s (for TO-220AB, ITO-220AB and TO-262AA package)
- Component in accordance to RoHS 2002/95/EC and WEEE 2002/96/EC



RoHS
COMPLIANT

TYPICAL APPLICATIONS

For use in high frequency inverters, switching power supplies, freewheeling diodes, OR-ing diode, dc-to-dc converters and reverse battery protection.

MECHANICAL DATA

Case: TO-220AB, ITO-220AB, TO-263AB and TO-262AA

Epoxy meets UL 94V-0 flammability rating

Terminals: Matte tin plated leads, solderable per J-STD-002 and JESD22-B102

E3 suffix for commercial grade, meets JESD 201 class 1A whisker test

Polarity: As marked

Mounting Torque: 10 in-lbs maximum

PRIMARY CHARACTERISTICS

| | |
|------------------------------|----------|
| $I_{F(AV)}$ | 2 x 10 A |
| V_{RRM} | 200 V |
| I_{FSM} | 120 A |
| V_F at $I_F = 10\text{ A}$ | 0.68 V |
| T_J max. | 150 °C |

MAXIMUM RATINGS ($T_A = 25\text{ °C}$ unless otherwise noted)

| PARAMETER | SYMBOL | V20200C | VF20200C | VB20200C | VI20200C | UNIT |
|--|----------------|---------------|----------|----------|----------|------|
| Maximum repetitive peak reverse voltage | V_{RRM} | 200 | | | | V |
| Maximum average forward rectified current (Fig. 1) per device per diode | $I_{F(AV)}$ | 20 10 | | | | A |
| Peak forward surge current 8.3 ms single half sine-wave superimposed on rated load per diode | I_{FSM} | 120 | | | | A |
| Peak repetitive reverse current at $t_p = 2\text{ }\mu\text{s}$, 1 kHz per diode | I_{RRM} | 0.5 | | | | A |
| Isolation voltage (ITO-220AB only) from terminal to heatsink $t = 1\text{ min}$ | V_{AC} | 1500 | | | | V |
| Operating junction and storage temperature range | T_J, T_{STG} | - 40 to + 150 | | | | °C |

| ELECTRICAL CHARACTERISTICS ($T_A = 25\text{ }^\circ\text{C}$ unless otherwise noted) | | | | | | |
|--|-----------------------|-----------------------------------|----------|---------------|------|---------------|
| PARAMETER | TEST CONDITIONS | | SYMBOL | TYP. | MAX. | UNIT |
| Breakdown voltage | $I_R = 1.0\text{ mA}$ | $T_A = 25\text{ }^\circ\text{C}$ | V_{BR} | 200 (minimum) | - | V |
| Instantaneous forward voltage per diode ⁽¹⁾ | $I_F = 5\text{ A}$ | $T_A = 25\text{ }^\circ\text{C}$ | V_F | 0.85 | - | V |
| | $I_F = 10\text{ A}$ | $T_A = 25\text{ }^\circ\text{C}$ | | 1.21 | 1.60 | |
| Reverse current per diode ⁽²⁾ | $V_R = 180\text{ V}$ | $T_A = 25\text{ }^\circ\text{C}$ | I_R | 6 | - | μA |
| | | $T_A = 125\text{ }^\circ\text{C}$ | | 3.6 | - | mA |
| | $V_R = 200\text{ V}$ | $T_A = 25\text{ }^\circ\text{C}$ | | - | 150 | μA |
| | | $T_A = 125\text{ }^\circ\text{C}$ | | 5.6 | 18 | mA |

Notes:

- (1) Pulse test: 300 μs pulse width, 1 % duty cycle
- (2) Pulse test: Pulse width $\leq 40\text{ ms}$

| THERMAL CHARACTERISTICS ($T_A = 25\text{ }^\circ\text{C}$ unless otherwise noted) | | | | | | |
|---|-----------------|---------|----------|----------|----------|--------------------|
| PARAMETER | SYMBOL | V20200C | VF20200C | VB20200C | VI20200C | UNIT |
| Typical thermal resistance per diode | $R_{\theta JC}$ | 2.8 | 5.0 | 2.8 | 2.8 | $^\circ\text{C/W}$ |

| ORDERING INFORMATION (Example) | | | | | |
|---------------------------------------|----------------|-----------------|--------------|---------------|---------------|
| PACKAGE | PREFERRED P/N | UNIT WEIGHT (g) | PACKAGE CODE | BASE QUANTITY | DELIVERY MODE |
| TO-220AB | V20200C-E3/4W | 1.88 | 4W | 50/tube | Tube |
| ITO-220AB | VF20200C-E3/4W | 1.75 | 4W | 50/tube | Tube |
| TO-263AB | VB20200C-E3/4W | 1.37 | 4W | 50/tube | Tube |
| TO-263AB | VB20200C-E3/8W | 1.37 | 8W | 800/reel | Tape and reel |
| TO-262AA | VI20200C-E3/4W | 1.45 | 4W | 50/tube | Tube |

RATINGS AND CHARACTERISTICS CURVES

($T_A = 25\text{ }^\circ\text{C}$ unless otherwise noted)

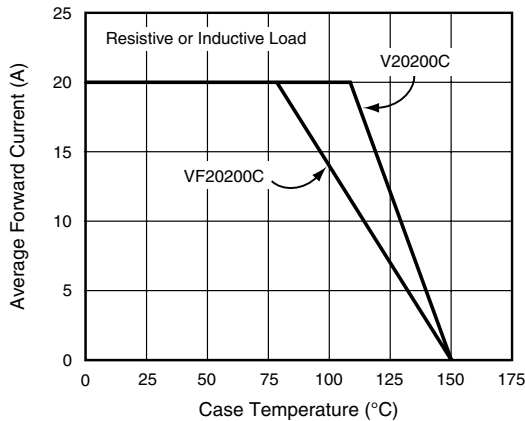

Figure 1. Maximum Forward Current Derating Curve

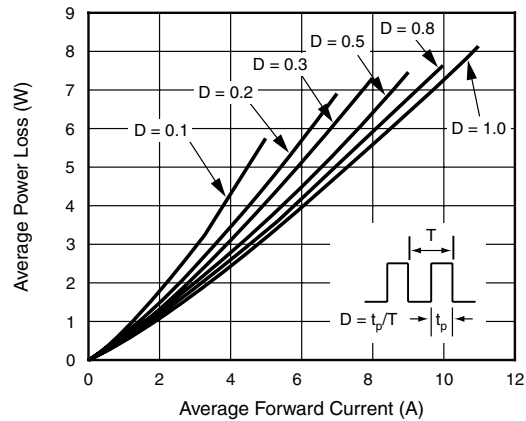

Figure 2. Forward Power Loss Characteristics Per Diode

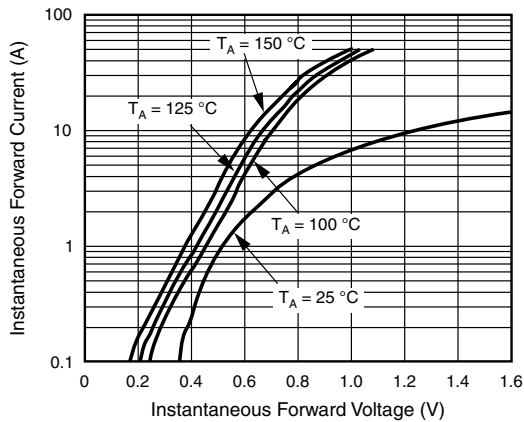

Figure 3. Typical Instantaneous Forward Characteristics Per Diode

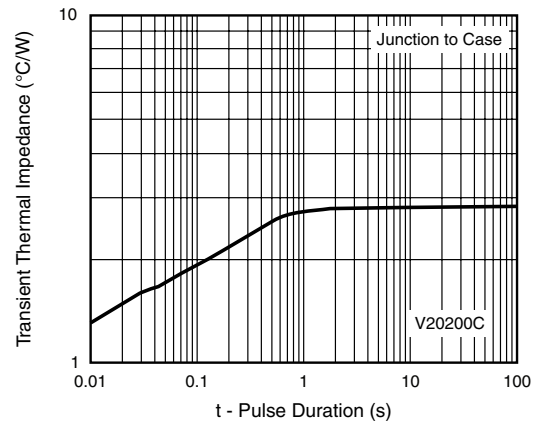

Figure 6. Typical Transient Thermal Impedance Per Diode

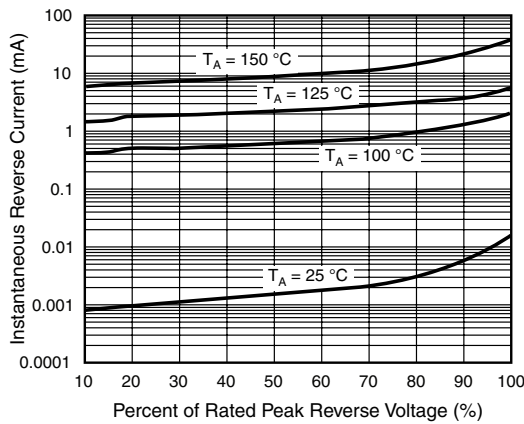

Figure 4. Typical Reverse Characteristics Per Diode

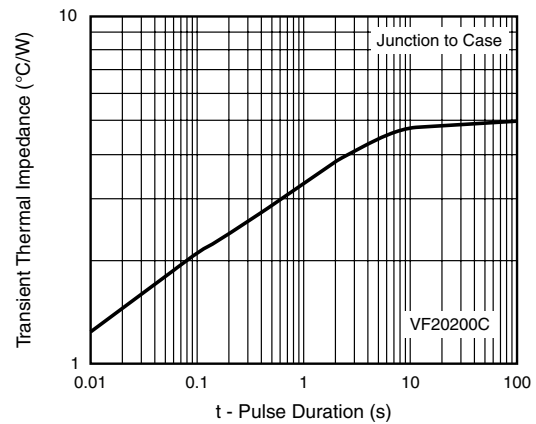

Figure 7. Typical Transient Thermal Impedance Per Diode

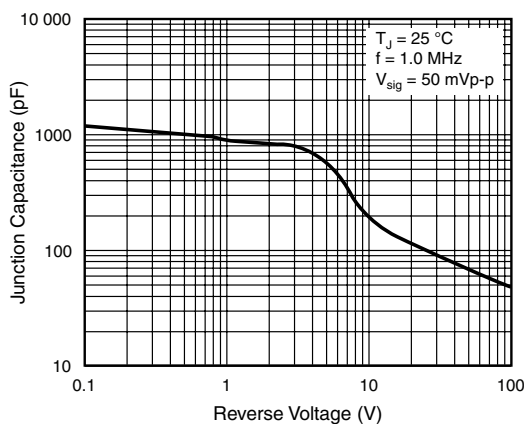

Figure 5. Typical Junction Capacitance Per Diode

New Product V20200C, VF20200C, VB20200C & VI20200C



Vishay General Semiconductor

PACKAGE OUTLINE DIMENSIONS in inches (millimeters)

TO-220AB

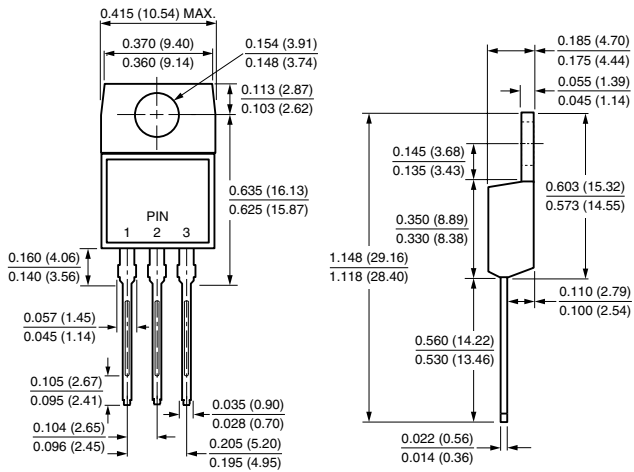

ITO-220AB

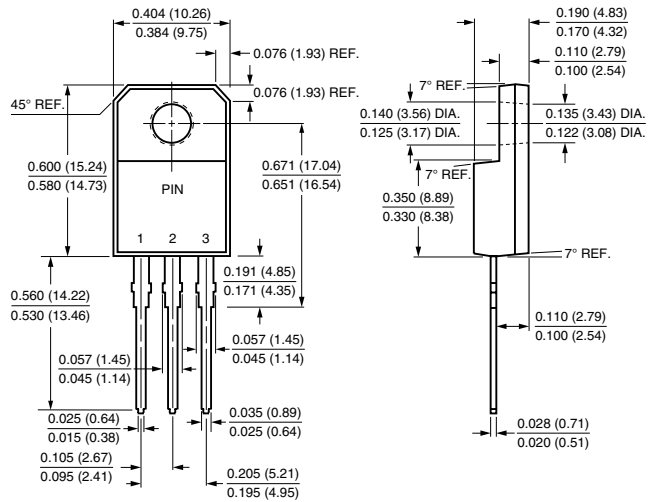

TO-262AA

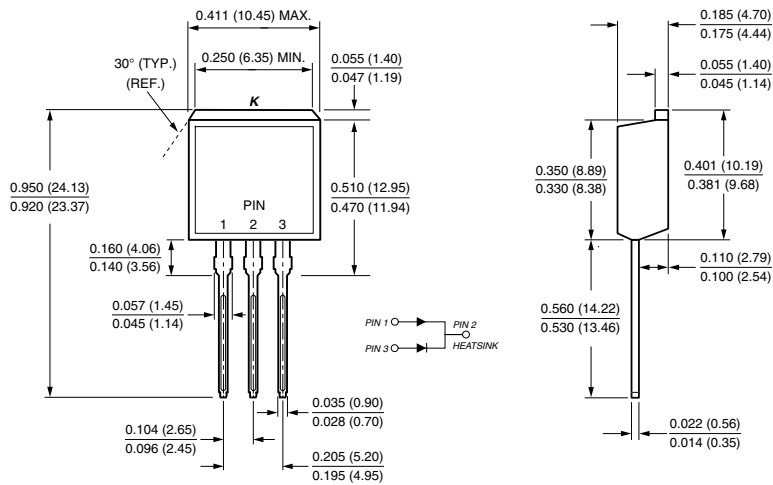

TO-263AB

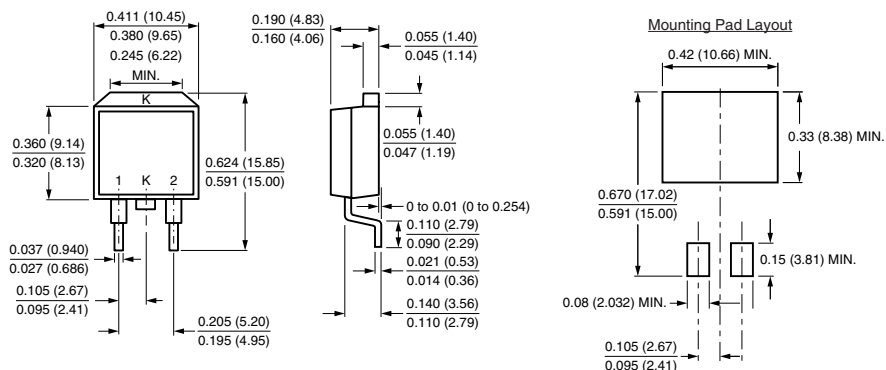



Disclaimer

All product specifications and data are subject to change without notice.

Vishay Intertechnology, Inc., its affiliates, agents, and employees, and all persons acting on its or their behalf (collectively, "Vishay"), disclaim any and all liability for any errors, inaccuracies or incompleteness contained herein or in any other disclosure relating to any product.

Vishay disclaims any and all liability arising out of the use or application of any product described herein or of any information provided herein to the maximum extent permitted by law. The product specifications do not expand or otherwise modify Vishay's terms and conditions of purchase, including but not limited to the warranty expressed therein, which apply to these products.

No license, express or implied, by estoppel or otherwise, to any intellectual property rights is granted by this document or by any conduct of Vishay.

The products shown herein are not designed for use in medical, life-saving, or life-sustaining applications unless otherwise expressly indicated. Customers using or selling Vishay products not expressly indicated for use in such applications do so entirely at their own risk and agree to fully indemnify Vishay for any damages arising or resulting from such use or sale. Please contact authorized Vishay personnel to obtain written terms and conditions regarding products designed for such applications.

Product names and markings noted herein may be trademarks of their respective owners.