

Timing Control Units CU1



Description

The CU1 is an on-delay timing unit designed to energize and thus unlock guard locking devices after a preset time delay expires. It can be used with power to unlock devices, like the Allen-Bradley Guardmaster Atlas, Spartan, 440G-MT, or TLS-GD2, on machines which have a run down cycle or do not stop immediately. It may also be incorporated into other parts of the safety related controls system, should a predictable, on-delay be required.

A removable cover allows access to the AC power switch, the replaceable fuse, and the DIP switches & potentiometer which control the timing. Power to the CU1 can be either 24V AC/DC (+/- terminals) or 110/230V AC (A1/A2 terminals). If 110V AC or 230V AC power is used, an internal switch must be set to the appropriate position.

The X1/X2 terminals are designed to monitor the performance of the contactors which isolate the power to the moving parts of the machinery. The timing can not begin until the X1/X2 loop is closed. The X1/X2 loop must remain closed during the whole timing cycle. Opening the X1/X2 loop during the timing cycle causes the time to be reset to zero. If monitoring is not needed, the X1/X2 loop can be linked.

A typical operation starts with the safety outputs (13/14 and 23/24) open and the X1/X2 loop closed.

1. Apply power to A1/A2 or +/- .
 - a. The Power LED turns ON and the Output LED turns red.
 - b. After the time delay expires, the Output LED turns green and the safety outputs (13/14 and 23/24) close.
2. Remove power to A1/A2 or +/- .
 - a. Immediately, the safety contacts (13/14 and 23/24) open, the Power LED turns off and the Output LED turns Off.
3. Go to step 1.

The status of the CU1 can be signaled to the Remote Indicator Unit via terminals R1/R2/R3, or to a PLC or other indicator by using the N.C. auxiliary contacts (31/32).

Features

- Category 1 per EN 954-1
- Stop category 1
- Timed on-delay output 0.1s to 40 min
- 2 N.O. safety outputs

Specifications

Standards	EN 954-1, ISO 13849-1, IEC/EN 60204-1, IEC 60947-5-1, ANSI B11.19, AS4024.1
Category	Cat. 1 per EN 954-1 (ISO13849-1)
Approvals	C-Tick, CE marked for all applicable directives, cULus & TÜV
Power Supply	24V AC/DC, 110/230V AC
Power Consumption	<4VA
Inputs	1 N.C.
Maximum Input Resistance	500 Ω
Reset	Automatic/manual
Outputs	2 N.O. Safety 1 N.C. Auxiliary
① Output Utilization per IEC 60947-5-1 (Inductive)	B300, AC-15 4A/250V AC, 4A/125VAC P300, DC-13: 3A/24V DC
Thermal Current (non switching)	2x4A
Timed Off-Delay	0.1s to 40min.
Fuses Input (external) Output (external)	500mA time lag 5A quick acting
Max. Switched Current/Voltage	10mA/10V
Indication LED	Red = Power on Red/Green = Timing/Output on
Impulse Withstand Voltage	2500V
Operating Temperature	-10°C to +55°C (+14°F to +131°F)
Humidity	90% RH
Enclosure Protection	IP40 DIN 0470
Terminal Protection	IP20 DIN 0470
Conductor Size	1 x 2.5mm ² (14AWG) stranded 1 x 4mm ² (12AWG) solid
Installation Group	C in accordance with VDE 0110
Pollution Degree	3
Torque Settings—terminal screws	1N·m (8 lb-in)
Case Material	Red Polycarbonate
Mounting	35mm DIN rail
Weight	360g (0.79lbs)
Electrical Life	220V AC/4A/880VA/cosφ=3.5 220V AC/1.7A/375VA/cosφ=0.6 30V DC/2A/60W 10V DC/0.01/0.1W
Mechanical Life	2,000,000 operations
Vibration	0.75mm(0.03in) peak, 10-55Hz
Shock	30g, 11ms half-sine

① See Output Ratings on page 1-29 for details. Consult factory for ratings not shown.

Product Selection

Inputs	Safety Outputs	Auxiliary Outputs	Power Supply	Catalogue Number
1 N.O.	2 N.O.	1 N.C.	24V AC/DC and 110/230V AC	440R-T07114

Accessories

Description	Page Number	Catalogue Number
500mA Fuse	14-6	440R-A31562
CU1 Remote Indication Unit	—	440R-A07138

Dimensions—mm (inches)

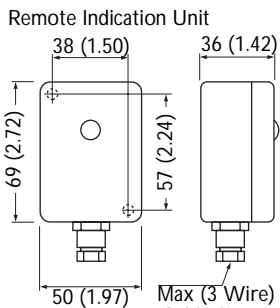
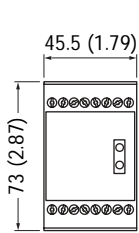
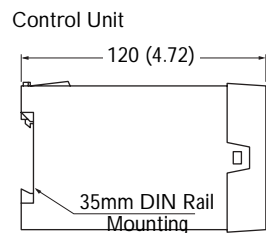

Max (3 Wire)
Cable Size 6mm Ø

Block Diagram

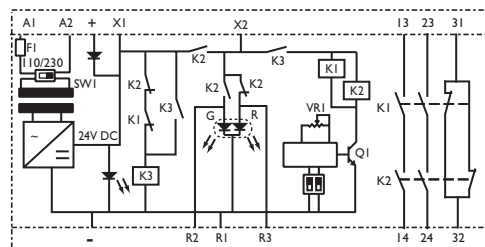

Typical Wiring Diagrams

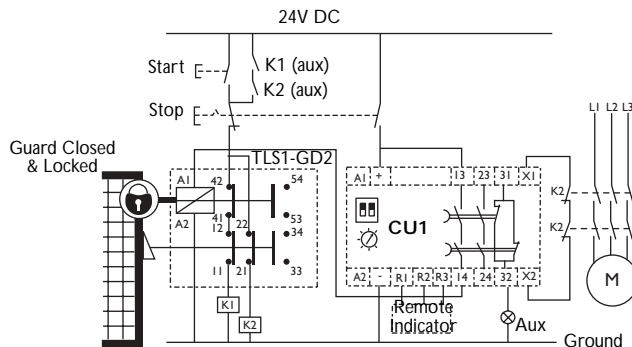

Guard Locking Safety Gate, Delayed Gate Release, Automatic Reset, Monitored Output

Application Details

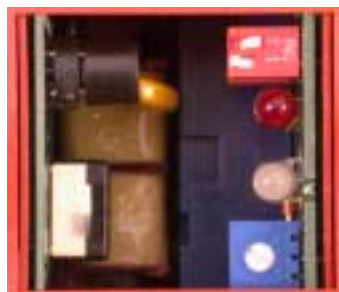

Adjustable Time Delay

DIP switches general time setting and the potentiometer fine tunes the time settings. Easy access 500mAAT replaceable fuse.

General time settings via DIP switches

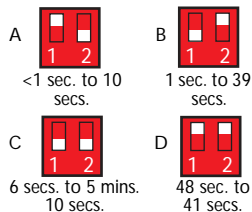

Fine adjustment time setting via potentiometer

