

Support pour 8 Relais SP/ST

Socket for 8 SP/ST relay

ESD08000

Implantation overview



Schéma de principe du module seul



configurations:

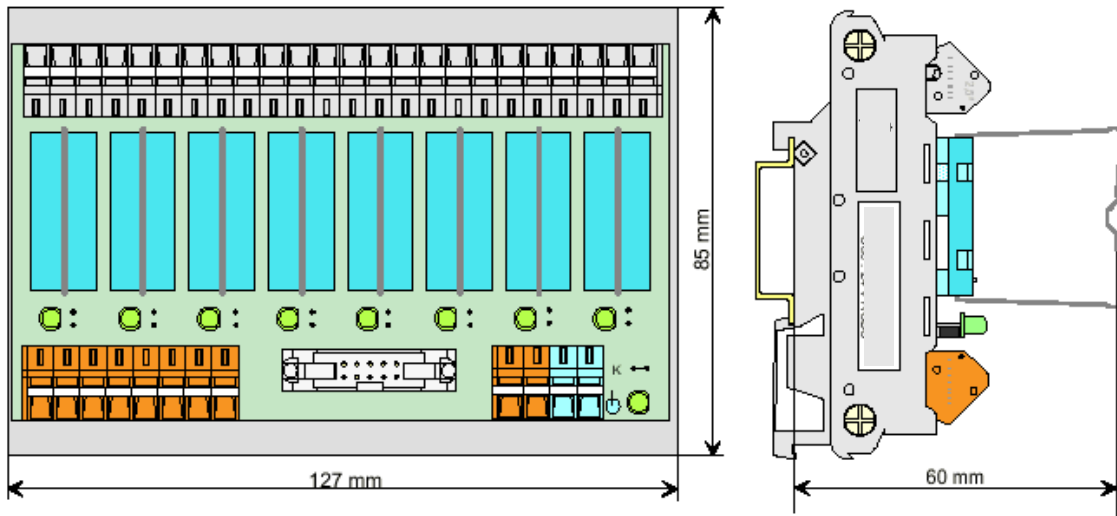
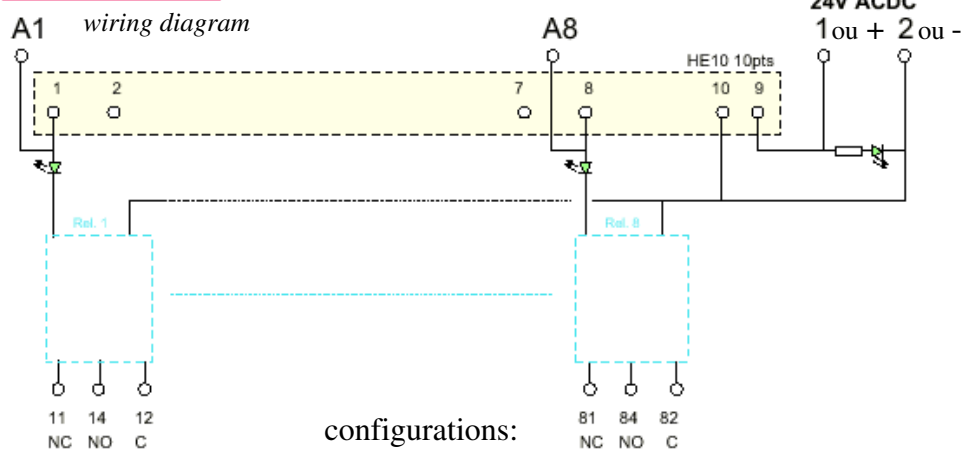
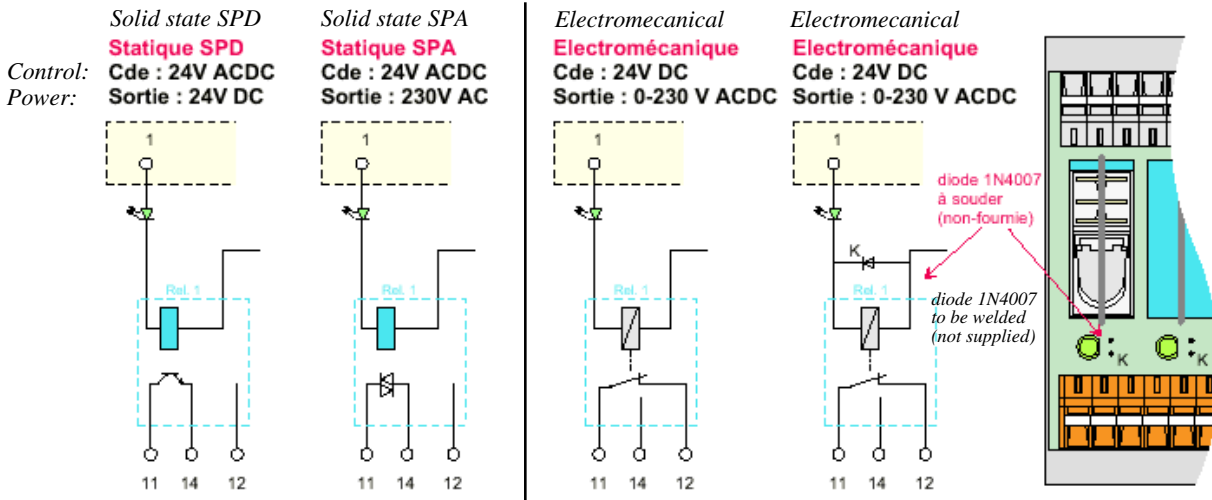

ISO 9001
N° 1993/1106a

Proud to serve you

All technical characteristics are subject to change without previous notice.
Caractéristiques sujettes à modifications sans préavis.

celduc®

r e l a i s

— www.celduc.com —