

SPECIFICATIONS FOR NICHIA CHIP TYPE WARM WHITE LED

MODEL : NS2L095AT

NICHIA CORPORATION

1.SPECIFICATIONS

(1) Absolute Maximum Ratings (Ts=25°C)

Item	Symbol	Absolute Maximum Rating	Unit
Forward Current	I _F	120	mA
Pulse Forward Current	I _{FP}	200	mA
Allowable Reverse Current	I _R	85	mA
Power Dissipation	P _D	480	mW
Operating Temperature	T _{opr}	-30 ~ + 85	°C
Storage Temperature	T _{stg}	-40 ~ +100	°C
Dice Temperature	T _j	130	°C
Soldering Temperature	T _{sld}	Reflow Soldering : 260°C for 10sec. Hand Soldering : 350°C for 3sec.	

I_{FP} Conditions : Pulse Width \leq 10msec. and Duty \leq 1/10

(2) Initial Electrical/Optical Characteristics (Ts=25°C)

Item	Symbol	Condition	Typ.	Max.	Unit	
Forward Voltage	V _F	I _F =60[mA]	(3.4)	4.0	V	
Luminous Flux	ϕ_v	I _F =60[mA]	(12.0)	-	lm	
Chromaticity Coordinate*	x	-	I _F =60[mA]	0.452	-	-
	y	-	I _F =60[mA]	0.409	-	-

* Please refer to CIE 1931 chromaticity diagram.

(3) Ranking (Ts=25°C)

Item	Symbol	Condition	Min.	Max.	Unit	
Luminous Flux	Rank P6	ϕ_v	I _F =60[mA]	12.7	15.1	lm
	Rank P5			10.7	12.7	
	Rank P4			9.0	10.7	
	Rank P3			7.6	9.0	

* Luminous Flux Measurement allowance is \pm 7%.

Color Ranks (I_F=60mA, Ts=25°C)

Rank d1						
x	0.3575	0.3610	0.3780	0.3988	0.3897	0.3720
y	0.3612	0.3850	0.3970	0.4116	0.3823	0.3714

Rank d2						
x	0.3545	0.3575	0.3720	0.3897	0.3822	0.3667
y	0.3408	0.3612	0.3714	0.3823	0.3580	0.3484

Rank e1						
x	0.3897	0.3988	0.4162	0.4390	0.4255	0.4053
y	0.3823	0.4116	0.4200	0.4310	0.4000	0.3907

	Rank e2					
x	0.3822	0.3897	0.4053	0.4255	0.4129	0.3954
y	0.3580	0.3823	0.3907	0.4000	0.3725	0.3642

	Rank f3			
x	0.4255	0.4390	0.4680	0.4519
y	0.4000	0.4310	0.4385	0.4086

	Rank f4			
x	0.4519	0.4680	0.4970	0.4770
y	0.4086	0.4385	0.4466	0.4137

	Rank f5			
x	0.4129	0.4255	0.4519	0.4355
y	0.3725	0.4000	0.4086	0.3785

	Rank f6			
x	0.4355	0.4519	0.4770	0.4588
y	0.3785	0.4086	0.4137	0.3838

* Color Coordinates Measurement allowance is ± 0.01 .

* Basically, a shipment shall consist of the LEDs of a combination of the above ranks.

The percentage of each rank in the shipment shall be determined by Nichia.

Correspondence table of Color Coordinates – Luminous Flux ranks

Ranking by Luminous Flux \ Ranking by Color Coordinates	P3	P4	P5	P6
d1, d2				
e1, e2				
f3, f4, f5, f6				

* Shaded ranks are available.

Chromaticity Coordinate – Luminous Flux (Reference)

Ranking by Color Coordinates	Chromaticity Coordinate	Luminous Flux
d1, d2	(0.3720,0.3714)	(13.5)lm
e1, e2	(0.41,0.39)	(12.5)lm
f3, f4, f5, f6	(0.452,0.409)	(12.0)lm

2. INITIAL OPTICAL/ELECTRICAL CHARACTERISTICS

Please refer to figure's page.

3. OUTLINE DIMENSIONS AND MATERIALS

Please refer to figure's page.

Material as follows ; Package : Ceramics
 Encapsulating Resin : Silicone Resin (with Phosphor)
 Electrodes : Ag Plating

4.PACKAGING

- The LEDs are packed in cardboard boxes after taping.
Please refer to figure's page.
The label on the minimum packing unit shows ; Part Number, Lot Number, Ranking, Quantity
- In order to protect the LEDs from mechanical shock, we pack them in cardboard boxes for transportation.
- The LEDs may be damaged if the boxes are dropped or receive a strong impact against them,
so precautions must be taken to prevent any damage.
- The boxes are not water resistant and therefore must be kept away from water and moisture.
- When the LEDs are transported, we recommend that you use the same packing method as Nichia.

5.LOT NUMBER

The first six digits number shows **lot number**.

The lot number is composed of the following characters;

○□×××× - △■

- - Year (6 for 2006, 7 for 2007)
- - Month (1 for Jan., 9 for Sep., A for Oct., B for Nov.)
- ×××× - Nichia's Product Number
- △ - Ranking by Color Coordinates
- - Ranking by Luminous Flux

6.RELIABILITY

(1) TEST ITEMS AND RESULTS

Test Item	Standard Test Method	Test Conditions	Note	Number of Damaged
Resistance to Soldering Heat (Reflow Soldering)	JEITA ED-4701 300 301	Tsld=260°C, 10sec. (Pre treatment 30°C,70%,168hrs.)	2 times	0/22
Solderability (Reflow Soldering)	JEITA ED-4701 300 303	Tsld=215 ± 5°C, 3sec. (Lead Solder)	1 time over 95%	0/22
Temperature Cycle	JEITA ED-4701 100 105	-40°C ~ 25°C ~ 100°C ~ 25°C 30min. 5min. 30min. 5min.	100 cycles	0/50
Moisture Resistance Cyclic	JEITA ED-4701 200 203	25°C ~ 65°C ~ -10°C 90%RH 24hrs./1cycle	10 cycles	0/50
High Temperature Storage	JEITA ED-4701 200 201	Ta=100°C	1000 hrs.	0/50
Temperature Humidity Storage	JEITA ED-4701 100 103	Ta=60°C, RH=90%	1000 hrs.	0/50
Low Temperature Storage	JEITA ED-4701 200 202	Ta=-40°C	1000 hrs.	0/50
Steady State Operating Life		Ta=25°C, IF=120mA Tested with Nichia standard circuit board.*	1000 hrs.	0/50
Steady State Operating Life of High Temperature		Ta=85°C, IF=110mA Tested with Nichia standard circuit board.*	1000 hrs.	0/50
Steady State Operating Life of High Humidity Heat		60°C, RH=90%, IF=120mA Tested with Nichia standard circuit board.*	500 hrs.	0/50
Steady State Operating Life of Low Temperature		Ta=-30°C, IF=60mA Tested with Nichia standard circuit board.*	1000 hrs.	0/50
Vibration	JEITA ED-4701 400 403	100 ~ 2000 ~ 100Hz Sweep 4min. 200m/s ² 3directions, 4cycles	48min.	0/10

* Thermal resistance of LED with Nichia standard circuit board : $R_{ja} \cong 110^{\circ}\text{C}/\text{W}$
Nichia standard circuit board : FR4, t=1.6mm, Copper foil, t=0.07mm

(2) CRITERIA FOR JUDGING DAMAGE

Item	Symbol	Test Conditions	Criteria for Judgement	
			Min.	Max.
Forward Voltage	V _F	I _F =60mA	-	Initial Level × 1.1
Luminous Flux	φ _v	I _F =60mA	Initial Level × 0.7	-

* The test is performed after the board is cooled down to the room temperature.

7.CAUTIONS

The LEDs are devices which are materialized by combining Blue LEDs and special phosphors. Consequently, the color of the LEDs is changed a little by an operating current. Care should be taken after due consideration when using LEDs.

(1) Moisture Proof Package

- When moisture is absorbed into the SMT package it may vaporize and expand during soldering. There is a possibility that this can cause exfoliation of the contacts and damage the optical characteristics of the LEDs. For this reason, the moisture proof package is used to keep moisture to a minimum in the package.
- The moisture proof package is made of an aluminum moisture proof bag. A package of a moisture absorbent material (silica gel) is inserted into the aluminium moisture proof bag. The silica gel changes its color from blue to pink as it absorbs moisture.

(2) Storage

· Storage Conditions

Before opening the package :

The LEDs should be kept at 30°C or less and 90%RH or less. The LEDs should be used within a year. When storing the LEDs, moisture proof packaging with absorbent material (silica gel) is recommended.

After opening the package :

The LEDs should be kept at 30°C or less and 70%RH or less. The LEDs should be soldered within 168 hours (7days) after opening the package. If unused LEDs remain, they should be stored in the moisture proof packages, such as sealed containers with packages of moisture absorbent material (silica gel). It is also recommended to return the LEDs to the original moisture proof bag and to reseal the moisture proof bag again.

- If the moisture absorbent material (silica gel) has faded away or the LEDs have exceeded the storage time, baking treatment should be performed using the following condition.
Baking treatment : more than 24 hours at $65 \pm 5^{\circ}\text{C}$
- This product has silver plated metal parts that are inside and/or outside the package body. The silver plating becomes tarnished when being exposed to an environment which contains corrosive gases. Any LED with tarnished leads may lead to poor solderability and deterioration of optical characteristics. Please do not expose the LEDs to corrosive atmosphere during storage.
- After assembly and during use, silver plating can be affected by the corrosive gases emitted by components and materials in close proximity of the LEDs within an end product, and the gases entering into the product from the external atmosphere. The above should be taken into consideration when designing.
- Please avoid rapid transitions in ambient temperature, especially in high humidity environments where condensation can occur.

(3) Static Electricity

- Static electricity or surge voltage damages the LEDs.
It is recommended that a wrist band or an anti-electrostatic glove be used when handling the LEDs.
- All devices, equipment and machinery must be properly grounded. It is recommended that precautions be taken against surge voltage to the equipment that mounts the LEDs.
- When inspecting the final products in which LEDs were assembled, it is recommended to check whether the assembled LEDs are damaged by static electricity or not. It is easy to find static-damaged LEDs by a light-on test or a VF test at a lower current (below 2mA is recommended).
- Damaged LEDs will show some unusual characteristics such as the forward voltage becomes lower, or the LEDs do not light at the low current.
Criteria : (VF > 2.0V at IF=1mA)

(4) Application Design Considerations

- In designing a circuit, the current through each LED must not exceed its absolute maximum rating. It is recommended to use Circuit B which regulates the current flowing through each LED. In the meanwhile, when driving LEDs with a constant voltage in Circuit A, the current through the LEDs may vary due to the variation in forward voltage (V_F) of the LEDs. In the worst case, some LED may be subjected to stresses in excess of the absolute maximum rating.

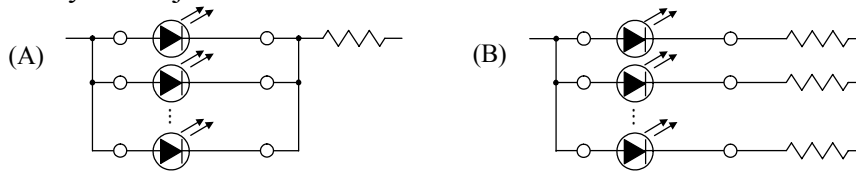

- Thermal design of the end product is of paramount importance. Please consider the heat generation of the LED when making the system design. The coefficient of temperature increase per input electric power is affected by the thermal resistance of the circuit board and density of LED placement on the board, as well as other components. It is necessary to avoid intense heat generation and operate within the maximum ratings given in this specification.
- Please determine the operating current with consideration of the ambient temperature local to the LED and refer to the plot of Ambient temperature vs. Allowable Forward Current on CHARACTERISTICS in this specifications. Please also take measures to remove heat from the area near the LED to improve the operational characteristics of the LED.
- The equation ① indicates correlation between T_j and T_a , and the equation ② indicates correlation between T_j and T_s .

$$T_j = T_a + R_{ja} \cdot W \quad \text{..... ①} \qquad T_j = T_s + R_{js} \cdot W \quad \text{..... ②}$$

- * T_j = Dice Temperature : °C, T_a = Ambient Temperature : °C,
- T_s = Solder Temperature (Cathode Side) : °C,
- R_{ja} = Heat resistance from Dice to Ambient temperature : °C /W,
- R_{js} = Heat resistance from Dice to T_s measuring point $\cong 55^\circ\text{C} /\text{W}$,
- W = Inputting Power ($I_F \times V_F$) : W

- Warpage of circuit board with soldered LEDs may result in damage or package breakage of the LEDs. Please pay special attention to the orientation of the LEDs as to avoid LED failure caused by bow, twist and warpage of the board.

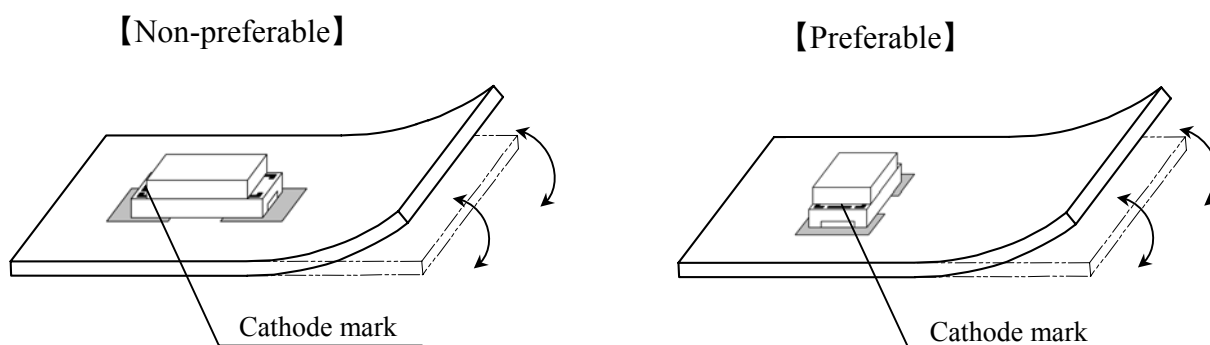

When mechanical stress from the board affects the soldered LED, place the LED in the preferable location and orientation as shown above.

- Depending on the position and direction of LED, the mechanical stress on the LED package can be changed. Refer to the following figure.

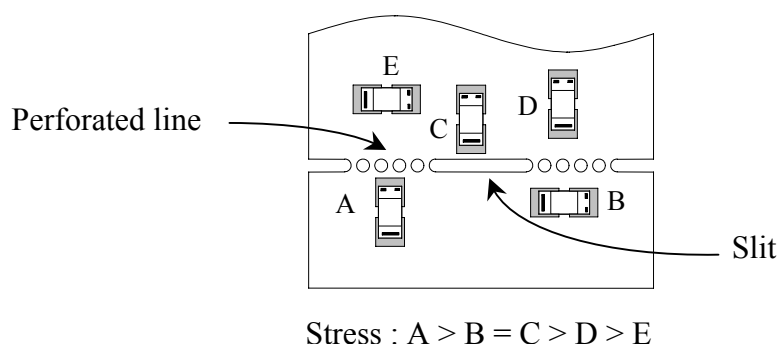

- When separating the circuit boards with soldered LEDs, please use appropriate tools and equipment. Hand brake without these tools and equipment may not be used.
- The use of aluminum substrate increases stress to solder joints due to thermal expansion of substrate and subsequently may result in solder joint crack. Users may need to evaluate their specific application to determine any impact due to the use of aluminum substrate.

(5) Handling Precautions

· Bare Hand

When handling the product, touching encapsulant with bare hands will contaminate its surface that could affect optical characteristics. In the worst cases, excessive force to the encapsulant by hands might result in catastrophic failure of the LEDs due to wire deformation and/or breakage.

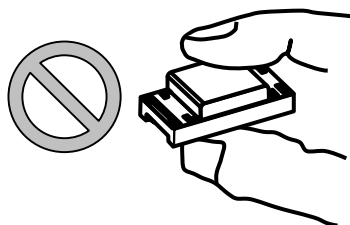

· Tweezers

When handling it with tweezers, the product should only be held by the package body, on the short side. Failure to comply might result in chip-out and/or delamination of encapsulant, and in the worst cases, catastrophic failure of the LEDs due to wire deformation and/or breakage.

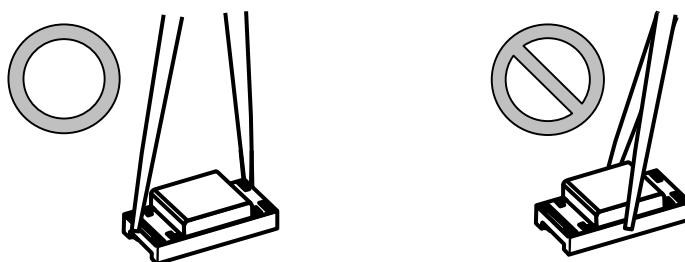

· Pick and Place

Recommended conditions : Area of outer nozzle $\geq 1.5 \text{ mm}^2$
(more than 45% of encapsulant top surface)**
Contact area of nozzle with encapsulant $\geq 1.0 \text{ mm}^2$
(30 to 60% of encapsulant top surface)**
Placement pressure $\leq 3 \text{ N/mm}^2$ *max. force : 5N
Vacuum pressure $\leq 7.8 \text{ N/cm}^2$ ($\leq 0.8 \text{ kgf/cm}^2$)
**For reference.

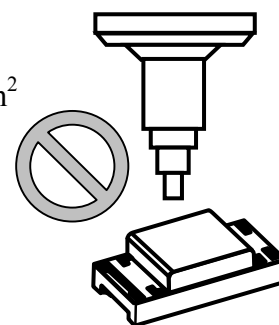

Failure to comply might result in damage to encapsulant and in the worst cases, catastrophic failure of the LEDs due to wire deformation and/or breakage.

· Printed Circuit Board Assembled (PCB with LEDs soldered)

Do not stack assembled PCBs together. Since silicone is a soft material, abrasion between two PCB assembled with silicone encapsulated LED might cause catastrophic failure of the LEDs due to damage to encapsulant (such as scratch, chip-out and delamination) and wire (such as deformation and breakage) and LED detachment.

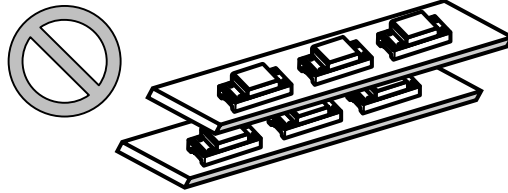

(6) Soldering Conditions

- The LEDs can be soldered in place using the reflow soldering method. Nichia cannot make a guarantee on the LEDs after they have been assembled using the dip soldering method.
- Recommended soldering conditions

	Reflow Soldering		Hand Soldering	
	Lead Solder	Lead-free Solder	Temperature	Soldering time
Pre-heat	120 ~ 150°C	180 ~ 200°C	350°C Max. 3 sec. Max. (one time only)	
Pre-heat time	120 sec. Max.	120 sec. Max.		
Peak temperature	240°C Max.	260°C Max.		
Soldering time	10 sec. Max.	10 sec. Max.		
Condition	refer to Temperature - profile ①.	refer to Temperature - profile ②. (N ₂ reflow is recommended.)		

* Although the recommended soldering conditions are specified in the above table, reflow or hand soldering at the lowest possible temperature is desirable for the LEDs.

* A rapid-rate process is not recommended for cooling the LEDs down from the peak temperature.

[Temperature-profile (Surface of circuit board)]

<① : Lead Solder>

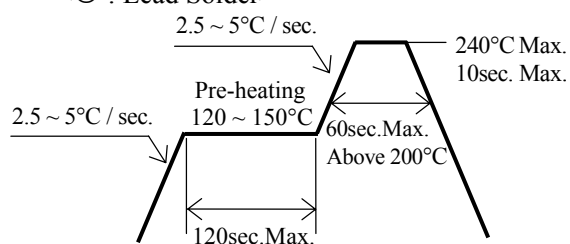

Use the conditions shown to the under figure.

<② : Lead-free Solder>

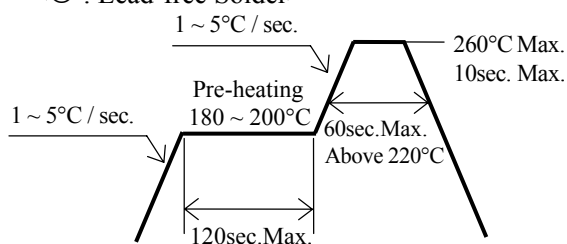

[Recommended soldering pad design]

Use the following conditions shown in the figure.

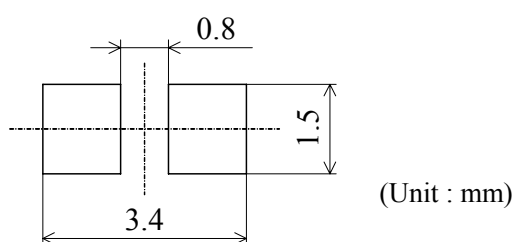

- Occasionally there is a brightness decrease caused by the influence of heat or ambient atmosphere during air reflow. It is recommended that the User use the nitrogen reflow method.
- Repairing should not be done after the LEDs have been soldered. When repairing is unavoidable, a double-head soldering iron should be used. It should be confirmed beforehand whether the characteristics of the LEDs will or will not be damaged by repairing.
- Reflow soldering should not be done more than two times.
- When soldering, do not put stress on the LEDs during heating.

(7) Cleaning

- It is recommended that isopropyl alcohol be used as a solvent for cleaning the LEDs. When using other solvents, it should be confirmed beforehand whether the solvents will dissolve the package and the resin or not. Freon solvents should not be used to clean the LEDs because of worldwide regulations.
- Do not clean the LEDs by the ultrasonic. When it is absolutely necessary, the influence of ultrasonic cleaning on the LEDs depends on factors such as ultrasonic power and the assembled condition. Before cleaning, a pre-test should be done to confirm whether any damage to the LEDs will occur.

(8) Others

- NS2L095A complies with RoHS Directive.
- The LED light output is strong enough to injure human eyes. Precautions must be taken to prevent looking directly at the LEDs with unaided eyes for more than a few seconds.
- Flashing lights have been known to cause discomfort in people; you can prevent this by taking precautions during use. Also, people should be cautious when using equipment that has had LEDs incorporated into it.
- The LEDs described in this brochure are intended to be used for ordinary electronic equipment (such as office equipment, communications equipment, measurement instruments and household appliances). Consult Nichia's sales staff in advance for information on the applications in which exceptional quality and reliability are required, particularly when the failure or malfunction of the LEDs may directly jeopardize life or health (such as for airplanes, aerospace, submersible repeaters, nuclear reactor control systems, automobiles, traffic control equipment, life support systems and safety devices).
- User shall not reverse engineer by disassembling or analysis of the LEDs without having prior written consent from Nichia. When defective LEDs are found, the User shall inform Nichia directly before disassembling or analysis.
- The formal specifications must be exchanged and signed by both parties before large volume purchase begins.
- The appearance and specifications of the product may be modified for improvement without notice.

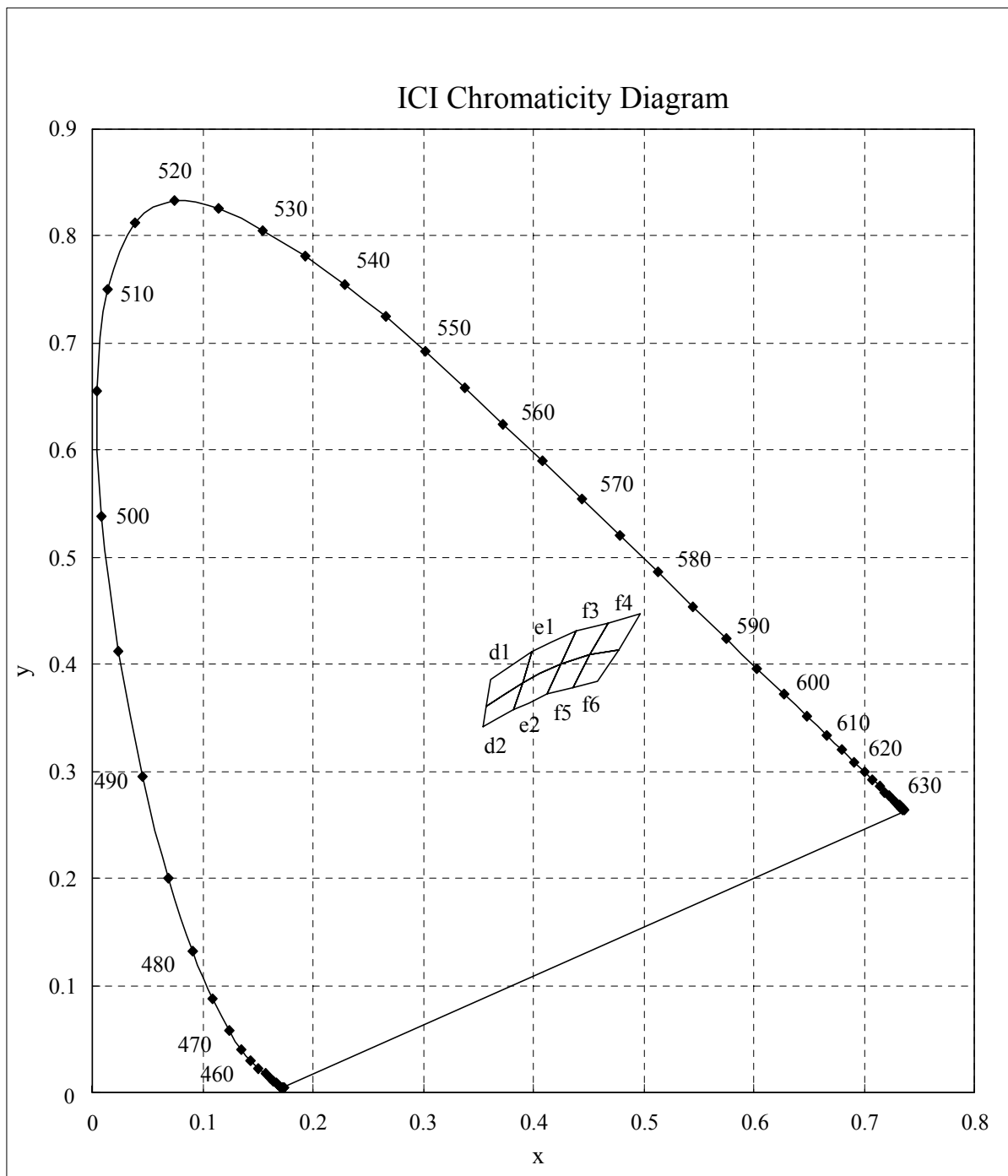

* Color Coordinates Measurement allowance is ± 0.01 .

■ Forward Voltage vs. Forward Current

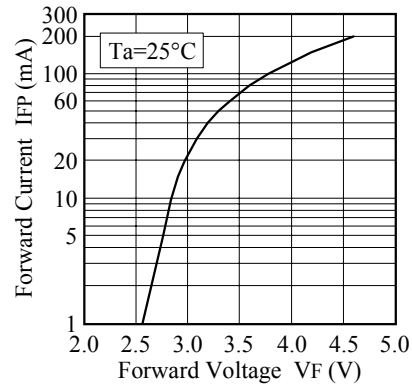

■ Forward Current vs. Relative Luminous Flux

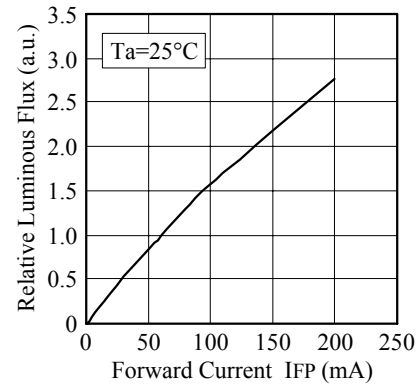

■ Duty Ratio vs. Allowable Forward Current

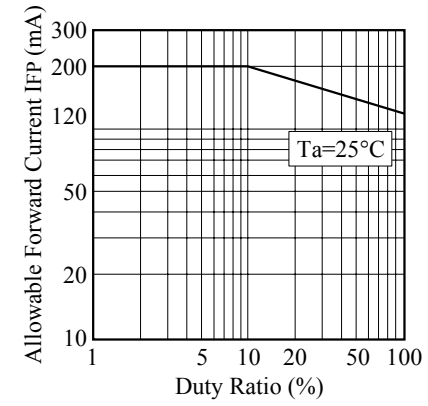

■ Ambient Temperature vs. Forward Voltage

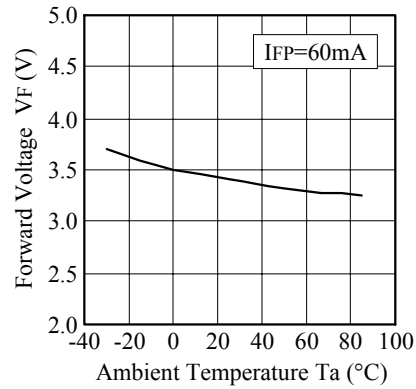

■ Ambient Temperature vs. Relative Luminous Flux

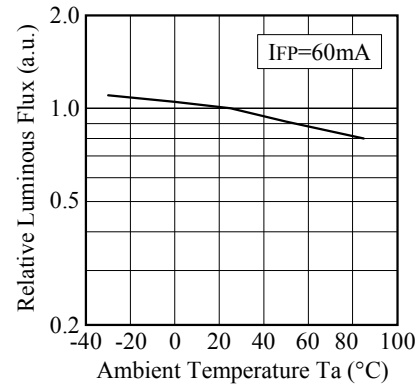

■ Ambient Temperature vs. Allowable Forward Current

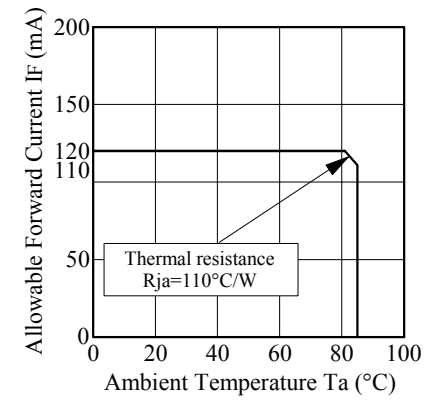

NICHIA CORPORATION	Model	NS2L095A
	Title	CHARACTERISTICS
	No.	071016701681

■ Forward Current vs. Chromaticity Coordinate

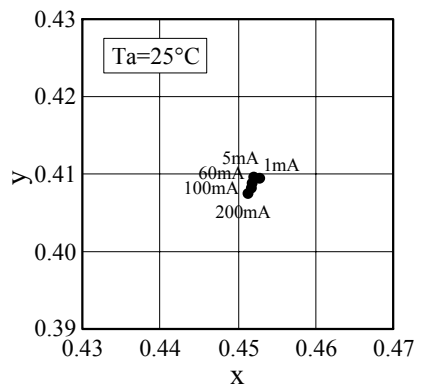

■ Spectrum

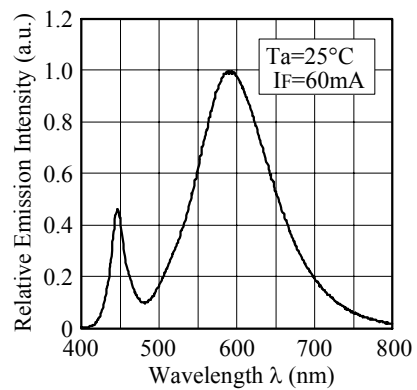

■ Ambient Temperature vs. Chromaticity Coordinate

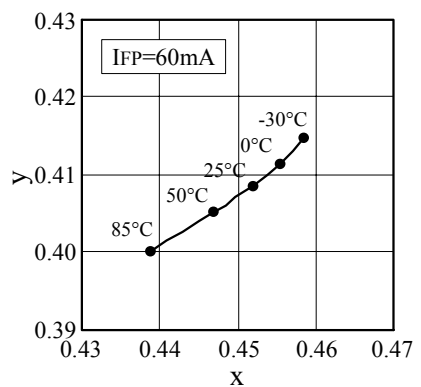

■ Directivity

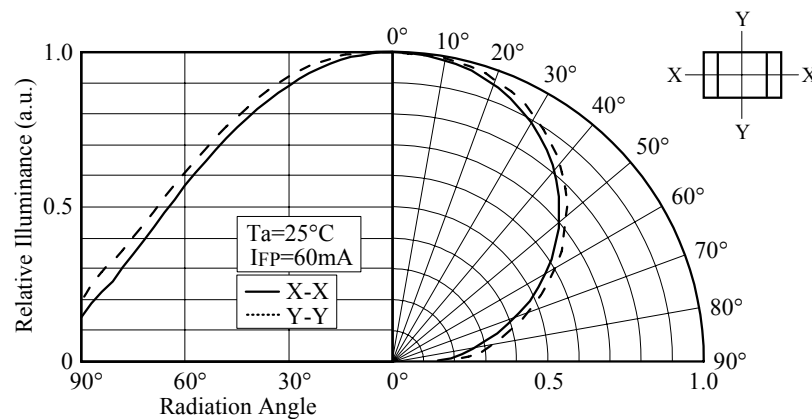

NICHIA CORPORATION	Model	NS2L095A
	Title	CHARACTERISTICS
	No.	071016701691

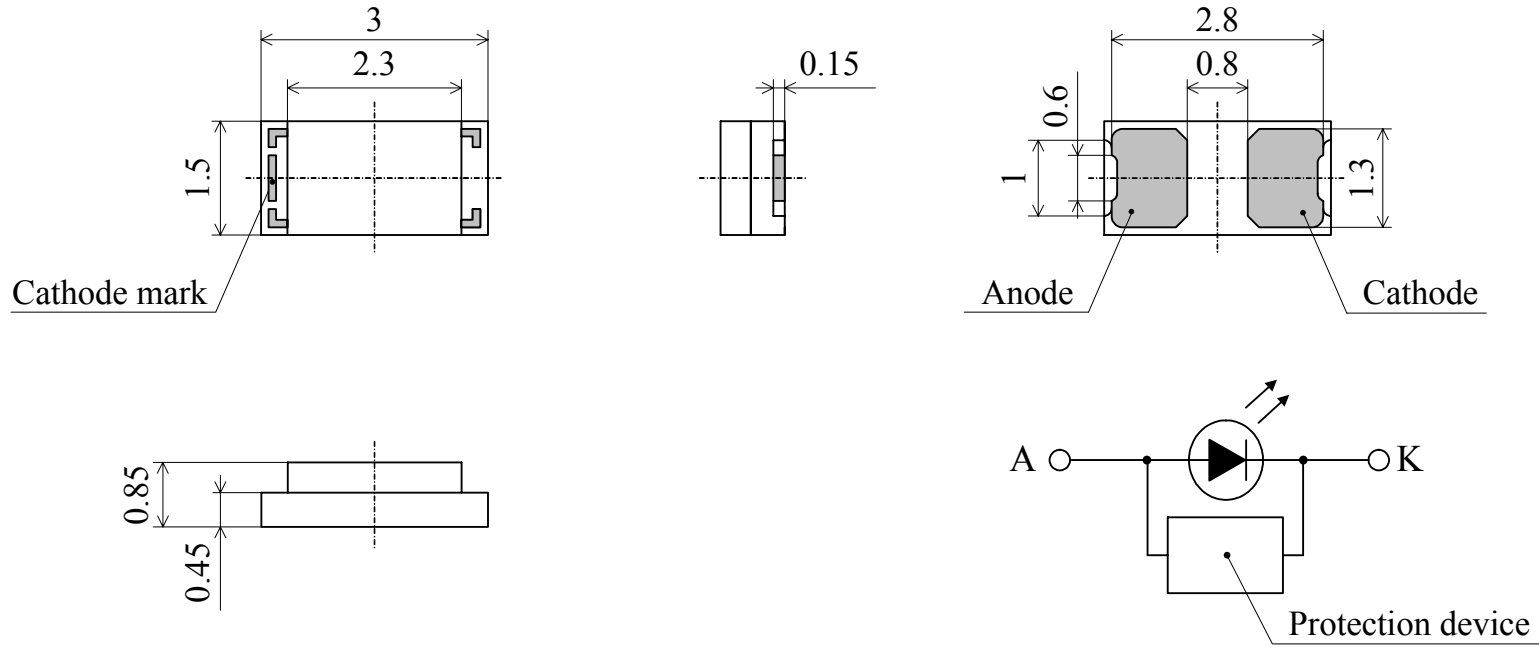

ITEM	MATERIALS
PACKAGE	Ceramics
ENCAPSULATING RESIN	Silicone Resin (with Phosphor)
ELECTRODES	Ag Plating

NICHIA CORPORATION	Model	NS2L095A	Unit mm
	Title	OUTLINE DIMENSIONS	
	No.	070903770451	Allow ±0.1

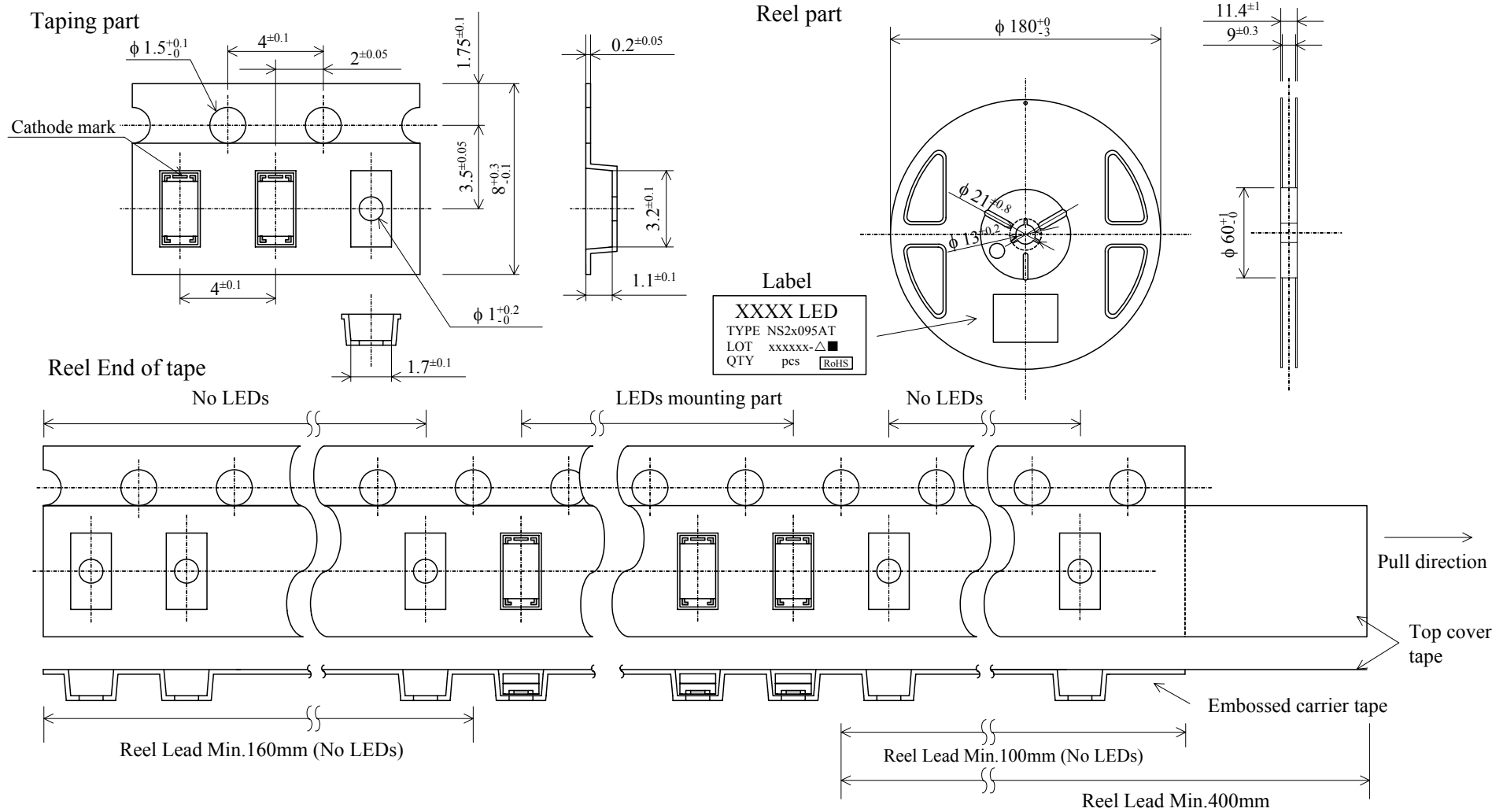

3,000pcs/Reel

Taping is based on the **JIS C 0806** : Packaging of Electronic Components on Continuous Tapes.

NICHIA CORPORATION	Model	NS2x095AT	Unit mm
	Title	TAPING DIMENSIONS	
	No.	070905770491	Scale Allow

The reel and moisture absorbent material are put in the moisture proof foil bag and then heat sealed.

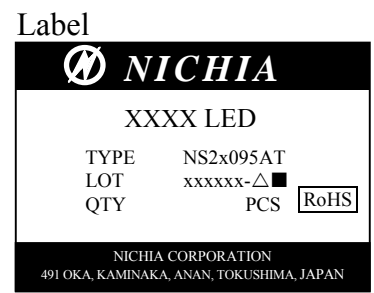
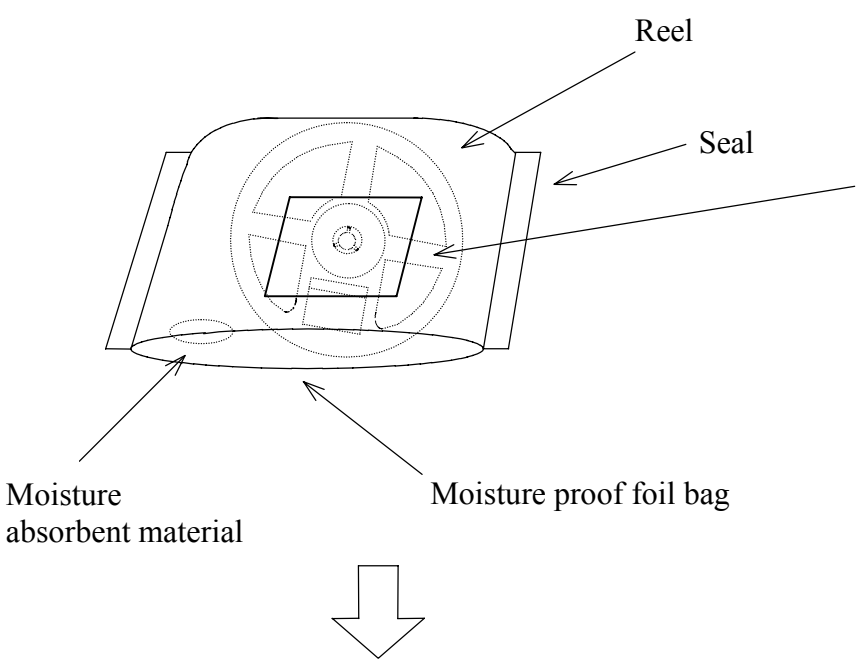

The box is partitioned with the cardboard.

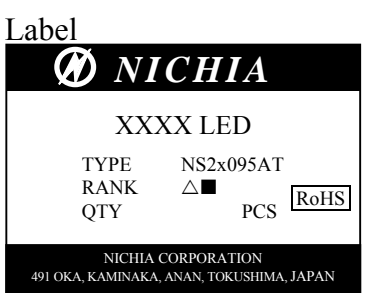
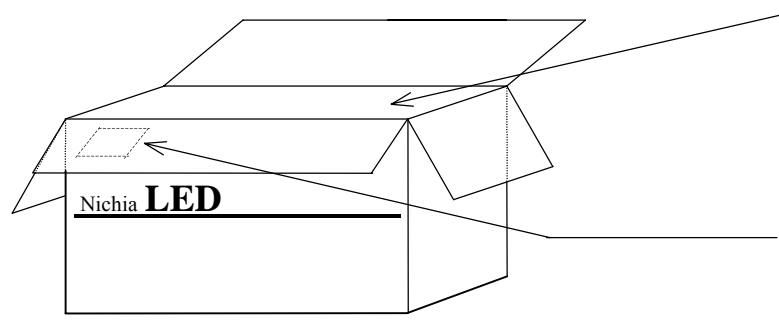

Packing unit

	Reel/bag	Quantity/bag (pcs)
Moisture proof foil bag	1reel	3,000 MAX.

Cardboard box	Dimensions (mm)	Reel/box	Quantity/box (pcs)
Cardboard box S	291×237×120×8t	7reel MAX.	21,000 MAX.
Cardboard box M	259×247×243×5t	15reel MAX.	45,000 MAX.
Cardboard box L	444×262×259×8t	30reel MAX.	90,000 MAX.

NICHIA CORPORATION	Model	NS2x095AT	/
	Title	PACKING	
	No.	070905770511	