



SANYO Semiconductors

# DATA SHEET

## LV4901H — Bi-CMOS LSI Built-in 80mW Headphone amplifier BTL 10W×2ch Class-D Audio Power Amplifier

### Overview

The LV4901H is a 10W per channel stereo digital power amplifier that takes analog inputs. The LV4901H uses unique SANYO-developed feedback technology to achieve excellent audio quality despite being a class D amplifier and can be used to implement high quality flat display panel (FDP) based systems.

### Features

- Supports circuit designs that do not require output LC filters
- BTL output, class D amplifier system
- Unique SANYO-developed feedback technology achieves superb audio quality
- High-efficiency class D amplifier, Low EMI
- Soft muting function reduces impulse noise at power on/off
- Full complement of built-in protection circuits : overcurrent protection, thermal protection, and low power supply voltage protection circuits
- Built in boot strap diode
- Built in Headphone amplifier

### Functions

- 10W output ( $V_D = 12V$ ,  $R_L = 8\Omega$ ,  $THD + N = 10\%$ )
- Efficiency :  $\eta > 85\%$  ( $V_D = 12V$ ,  $R_L = 8\Omega$ ,  $f_{in} = 1kHz$ ,  $P_O = 10W$ )
- 80mW Stereo Headphone amplifier ( $V_D = 12V$ ,  $R_L = 16\Omega$ ,  $THD + N = 10\%$ )
- Package HSOP-36

■ Any and all SANYO Semiconductor Co.,Ltd. products described or contained herein are, with regard to "standard application", intended for the use as general electronics equipment (home appliances, AV equipment, communication device, office equipment, industrial equipment etc.). The products mentioned herein shall not be intended for use for any "special application" (medical equipment whose purpose is to sustain life, aerospace instrument, nuclear control device, burning appliances, transportation machine, traffic signal system, safety equipment etc.) that shall require extremely high level of reliability and can directly threaten human lives in case of failure or malfunction of the product or may cause harm to human bodies, nor shall they grant any guarantee thereof. If you should intend to use our products for applications outside the standard applications of our customer who is considering such use and/or outside the scope of our intended standard applications, please consult with us prior to the intended use. If there is no consultation or inquiry before the intended use, our customer shall be solely responsible for the use.

■ Specifications of any and all SANYO Semiconductor Co.,Ltd. products described or contained herein stipulate the performance, characteristics, and functions of the described products in the independent state, and are not guarantees of the performance, characteristics, and functions of the described products as mounted in the customer's products or equipment. To verify symptoms and states that cannot be evaluated in an independent device, the customer should always evaluate and test devices mounted in the customer's products or equipment.

**SANYO Semiconductor Co., Ltd.**

TOKYO OFFICE Tokyo Bldg., 1-10, 1 Chome, Ueno, Taito-ku, TOKYO, 110-8534 JAPAN

# LV4901H

## Specifications

### Absolute Maximum Ratings at $T_a = 25^\circ\text{C}$

Parameter	Symbol	Conditions	Ratings	Unit
Maximum supply voltage	VD	Externally applied voltage	14	V
Maximum output current	$I_{O \text{ peak}}$		3.5	A/ch
Allowable power dissipation	$P_d \text{ max}$	Independent package	886	mW
Operating temperature	$T_{opr}$		-25 to +75	$^\circ\text{C}$
Storage temperature	$T_{stg}$		-50 to +150	$^\circ\text{C}$

### Recommended Operating Conditions at $T_a = 25^\circ\text{C}$

Parameter	Symbol	Conditions	Ratings			Unit
			min	typ	max	
Recommended supply voltage range	VD	Externally applied voltage	10	12	13.5	V
Recommended load resistance	$R_L \text{ (SP)}$	Speaker load	4	8		$\Omega$
	$R_L \text{ (HP)}$	Headphone		16		$\Omega$

### Electrical Characteristics at $T_a = 25^\circ\text{C}$

Parameter	Symbol	Conditions	Ratings			Unit
			min	typ	max	
<b>Digital amplifier block</b> : VD = 12V, $R_L = 8\Omega$ , L = 22 $\mu\text{H}$ , C = 0.33 $\mu\text{F}$ , $C_L = 1\mu\text{F}$						
Standby current	$I_{st}$	$\overline{\text{STBY}} = \text{L}$ , $\overline{\text{MUTE}} = \text{L}$		13	25	$\mu\text{A}$
Mute current	$I_{mute}$	$\overline{\text{STBY}} = \text{H}$ , $\overline{\text{MUTE}} = \text{L}$		13	20	mA
Quiescent current	$I_{CCO}$	$\overline{\text{STBY}} = \text{H}$ , $\overline{\text{MUTE}} = \text{H}$		60	70	mA
Voltage gain	VG	$f_{in} = 1\text{kHz}$ , $V_O = 0\text{dBm}$	27	29	31	dB
Output offset voltage	$V_{offset}$	$R_g = 0$	-150		150	mV
Total harmonic distortion	THD@1W	$P_O = 1\text{W}$ , $f_{in} = 1\text{kHz}$ , AES17		0.2	0.8	%
Maximum output	$P_{O1@10\%}$	THD+N = 10%, AES17	8	10		W
Channel separation	CH sep.	$f_{in} = 1\text{kHz}$ , $V_O = 0\text{dBm}$ , $R_g = 0$ , DIN AUDIO	55	70		dB
Ripple rejection ratio	SVRR	$f_r = 100\text{Hz}$ , $V_r = 0\text{dBm}$ , $R_g = 0$ , A-weight	35	50		dB
Noise	$V_{NO}$	$R_g = 0$ , A-weight		200	500	$\mu\text{Vrms}$
High-level input voltage	$V_{IH}$	$\overline{\text{STBY}}$ pin and $\overline{\text{MUTE}}$ pin	3			V
Low-level input voltage	$V_{IL}$	$\overline{\text{STBY}}$ pin and $\overline{\text{MUTE}}$ pin			1	V
Power supply voltage drop protection circuit upper limit value	UV_UPPER	VD pin voltage monitor		8.0		V
Power supply voltage drop protection circuit lower limit value	UV_LOWER	VD pin voltage monitor		7.0		V
<b>Headphone amplifier block</b> : VD = 12V, $R_L = 16\Omega$ , $f_{in} = 1\text{kHz}$						
Quiescent current	$I_{CCO}^{hp}$	$\overline{\text{HP\_STBY}} = \text{H}$		5.5	9.5	mA
Voltage gain	VG	$V_O = -10\text{dBm}$	10	12	14	dB
Total harmonic distortion	THD	$P_O = 1\text{mW}$ , DIN AUDIO		0.25	0.8	%
Maximum output	$P_O$	THD = 10%, DIN AUDIO	60	80		mW
Channel separation	CH sep.	$f_{in} = 1\text{kHz}$ , $V_r = 0\text{dBm}$ , $R_g = 0$ , DIN AUDIO	35	45		dB
Ripple rejection ratio	SVRR	$f_r = 100\text{Hz}$ , $V_r = 0\text{dBm}$ , $R_g = 0$ , DIN AUDIO	55	70		dB
High-level input voltage	$V_{IH}$	$\overline{\text{HP\_STBY}}$ pin	3			V
Low-level input voltage	$V_{IL}$	$\overline{\text{HP\_STBY}}$ pin			1	V
Noise	$V_{NO}$	$R_g = 0\Omega$ , DIN AUDIO		50	200	$\mu\text{Vrms}$

Note : The values of these characteristics were measured in the SANYO test environment. The actual values in an end system will vary depending on the printed circuit board pattern, the external components actually used, and other factors.

# LV4901H

## Package Dimensions

unit : mm (typ)  
3235A

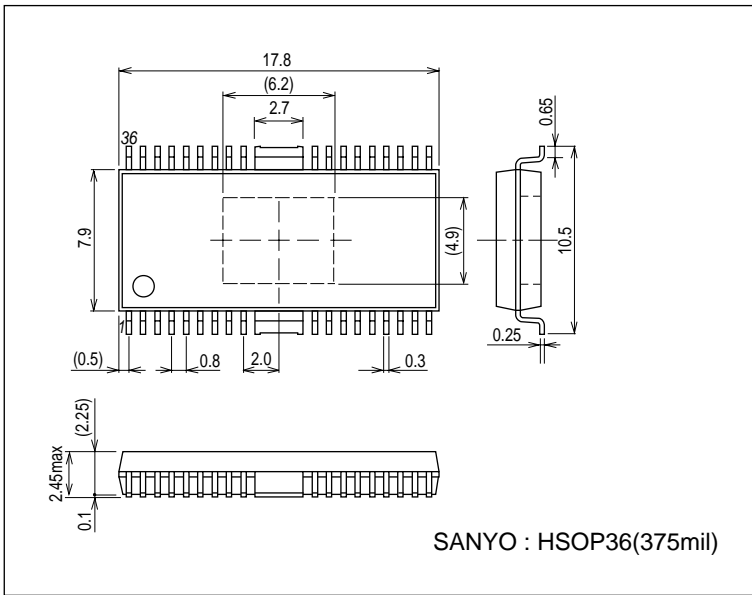

## Block Diagram ( $R_L = 8\Omega$ )

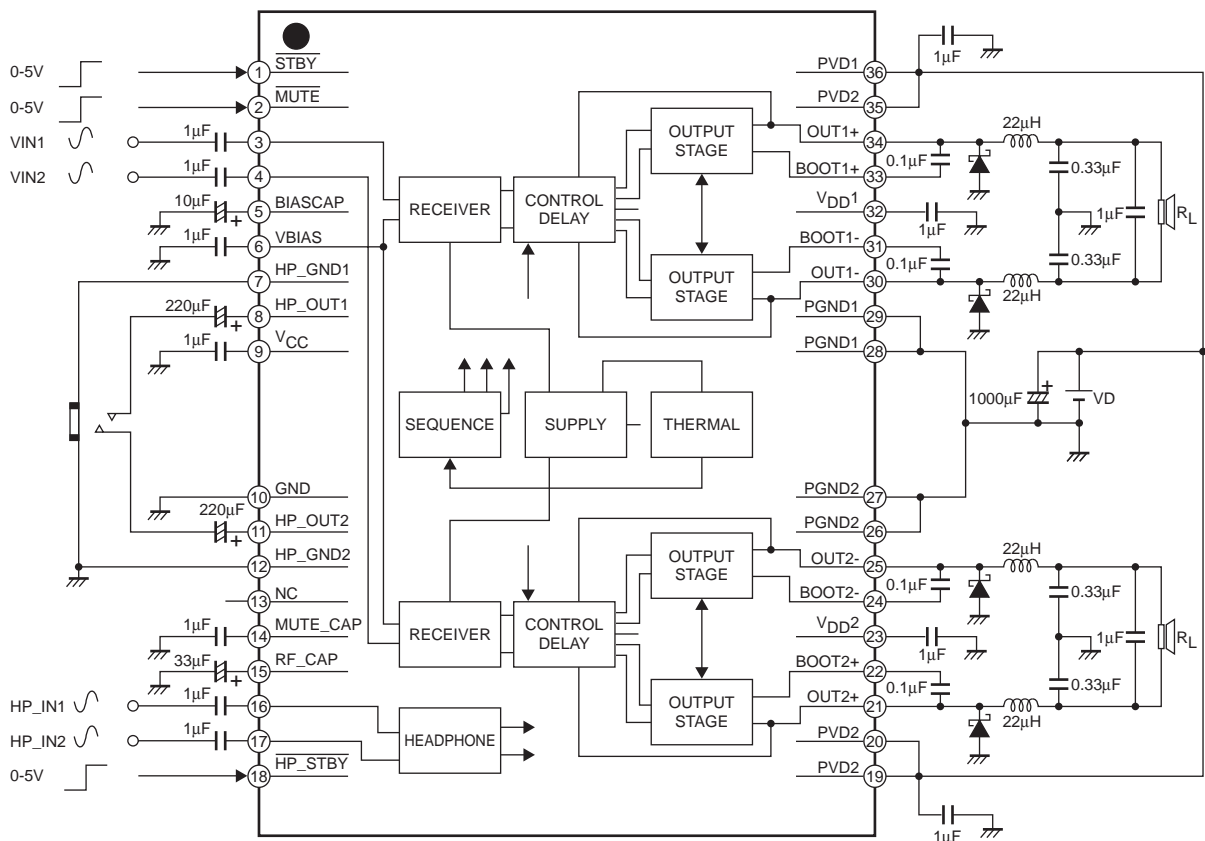

# LV4901H

## Pin Equivalent Circuit

Pin No.	Pin name	I/O	Description	Equivalent Circuit
1	$\overline{\text{STBY}}$	I	Standby mode control	
2	$\overline{\text{MUTE}}$	I	Muting control	
3	$V_{IN1}$	I	Channel 1 input	
4	$V_{IN2}$	I	Channel 2 input	
5	BIASCAP	O	Internal regulator decoupling capacitor connection	

Continued on next page.

# LV4901H

Continued from preceding page.

Pin No.	Pin name	I/O	Description	Equivalent Circuit
6	VBIAS	O	Internal regulator decoupling capacitor connection	
7	HP_GND1		Headphone ground of channel 1	
8	HP_OUT1	O	Headphone channel 1 output	
9	VCC	O	Internal power supply decoupling capacitor connection	
10	GND		Analog system ground	
11	HP_OUT2	O	Headphone channel 2 output	
12	HP_GND2		Headphone ground of channel 2	
13	NC		NC	
14	MUTE_CAP	O	Muting system capacitor connection	

\*VD2 : 9V line of Headphone Amp block

Continued on next page.

# LV4901H

Continued from preceding page.

Pin No.	Pin name	I/O	Description	Equivalent Circuit
15	RF_CAP	O	Headphone Ripple filter	
16	HP_IN1	I	Headphone channel 1 input	
17	HP_IN2	I	Headphone channel 2 input	
18	HP_STBY	I	Headphone standby mode control	
19	PVD2		Channel 2 power system power supply	
20	PVD2		Channel 2 power system power supply	
21	OUT2+	O	Channel 2 high side output	
22	BOOT2+	I/O	Boot strap terminal, Channe 2 positive supply of high side	

\*PREVD : 6V line of Headphone Amp block

Continued on next page.

# LV4901H

Continued from preceding page.

Pin No.	Pin name	I/O	Description	Equivalent Circuit
23	V <sub>DD2</sub>	O	Channel 2 internal regulator decoupling capacitor connection	
24	BOOT2-	I/O	Boot strap terminal, Channel 2 positive supply of high side	
25	OUT2-	O	Channel 2 low side output	
26	PGND2		Channel 2 power system ground	
27	PGND2		Channel 2 power system ground	
28	PGND1		Channel 1 power system ground	
29	PGND1		Channel 1 power system ground	
30	OUT1-	O	Channel 1 low side output	
31	BOOT1-	I/O	Boot strap terminal, Channel 1 positive supply of high side	
32	V <sub>DD1</sub>	O	Channel 1 internal regulator decoupling capacitor connection	
33	BOOT1+	I/O	Boot strap terminal, Channel 1 positive supply of high side	

Continued on next page.

# LV4901H

Continued from preceding page.

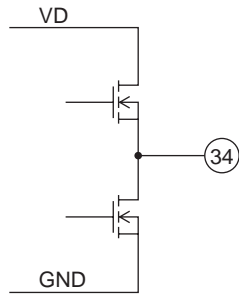
Pin No.	Pin name	I/O	Description	Equivalent Circuit
34	OUT1+	O	Channel 1 high side output	
35	PVD1		Channel 1 power system power supply	
36	PVD1		Channel 1 power system power supply	

Note : Smoothing capacitors must be connected to each power supply pin.



# LV4901H

LV4901H Customer bread board rev.1.0

Pattern

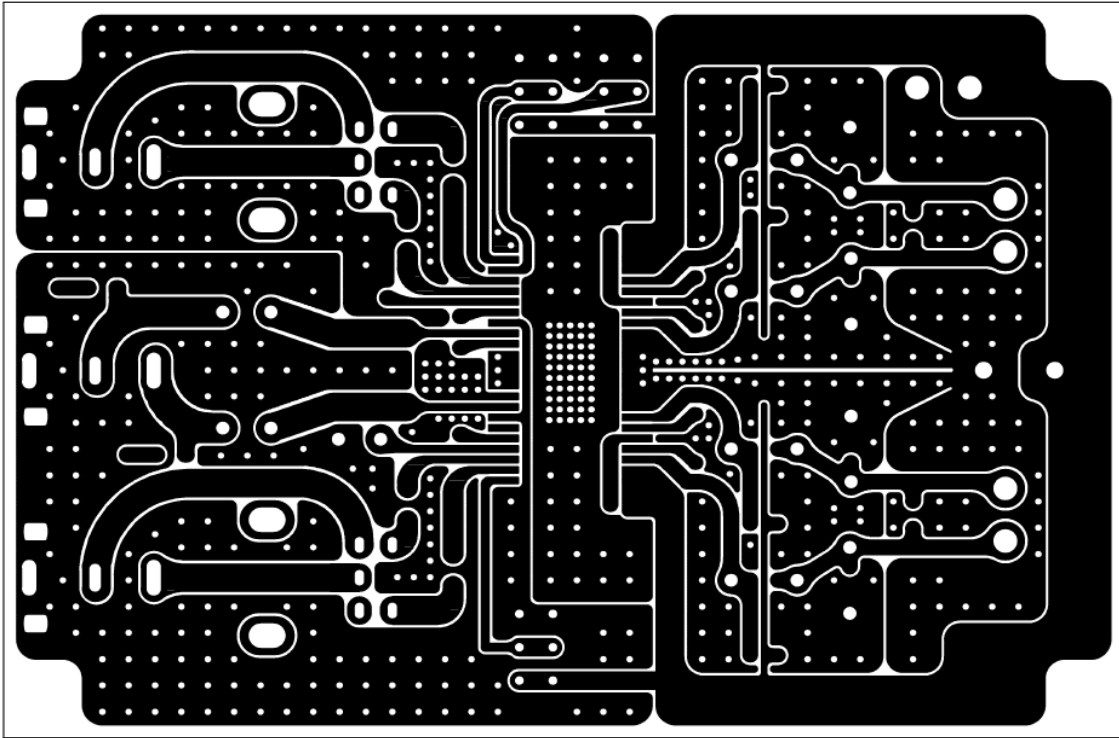

Silk

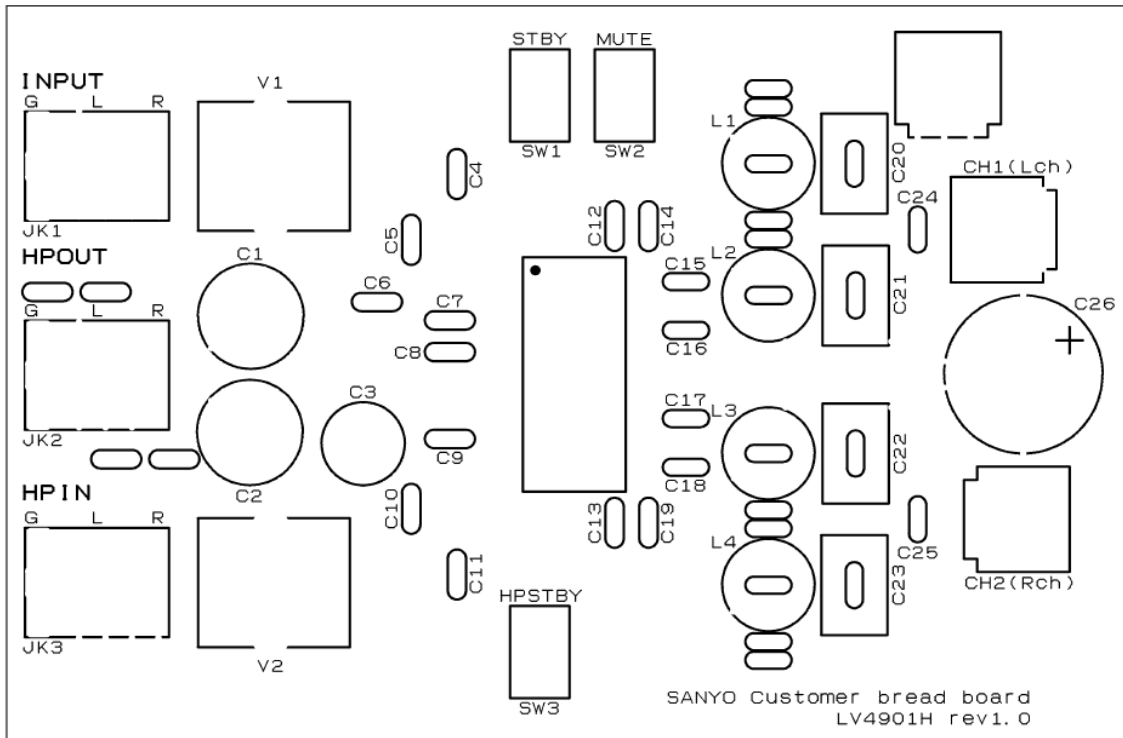

# LV4901H

## Components

Symbol	Part No.	Function
-----	JK1	Jack for D-Amp input.
-----	JK2	Jack for HP output.
-----	JK3	Jack for HP input.
-----	SW1	STBY switch. Lower position : standby state.
-----	SW2	MUTE switch. Lower position : mute state.
-----	SW3	HP stanby switch. Lower position : standby state.
CHPO	C1, C2	HP output coupling capacitors.
CRFCAP	C3	HP_Mute capacitor for soft mute.
CIN	C4, C5, C10, C11	Input coupling capacitors.
CBIASCAP	C6	Internal regulator (VBIAS) input decoupling capacitor.
CVBIAS	C7	Internal regulator (VBIAS) output decoupling capacitor.
CVCC	C8	Internal regulator (VCC) output decoupling capacitor.
CMUTE	C9	Soft muting time constant adjustment capacitor.
* CVDD	C12, C13	internal regulator (VDD) output decoupling capacitors.
* CVD	C14, C15	VD high-frequency attenuation capacitors.
* CBOOT	C16, C17, C18, C19	Boot strap capacitors.
L	L1, L2, L3, L4	Output low-pass filter coils : $f_c = 1 / (2\pi\sqrt{LC})$
C	C20, C21, C22, C23	Output low-pass filter capacitors.
CL	C24, C25	Capacitor between outputs.
CPVD	C26	VD power supply capacitor.

\* CVDD, CVD and CBOOT, Each capacitor is arranged in the neighborhood of IC as much as possible

# LV4901H

## Digital amplifier block characteristics

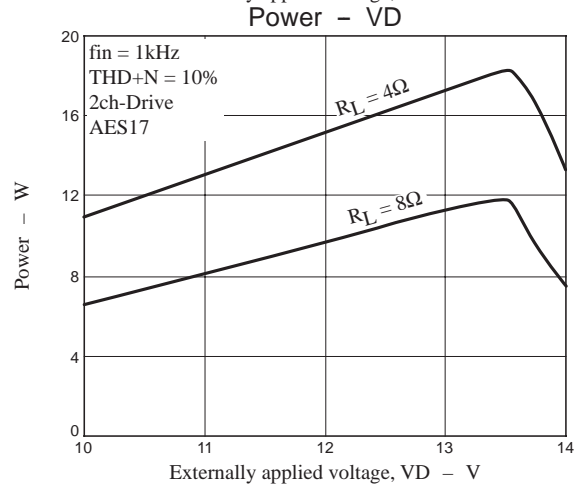
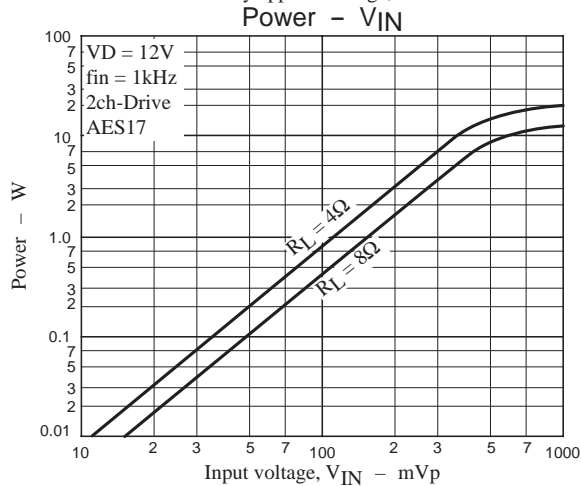
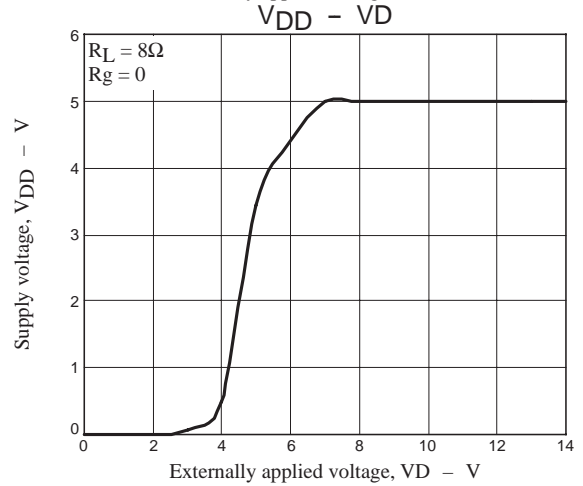
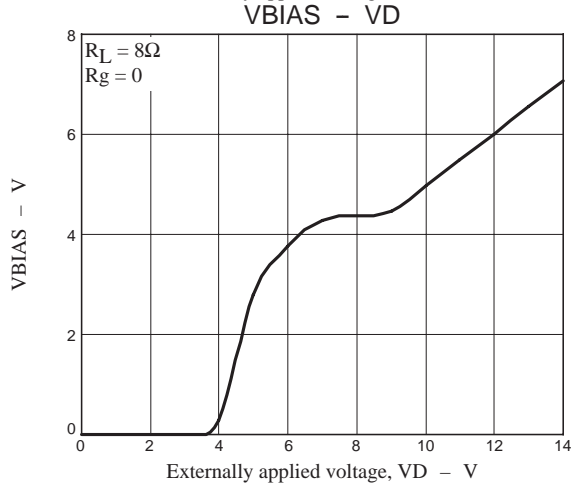
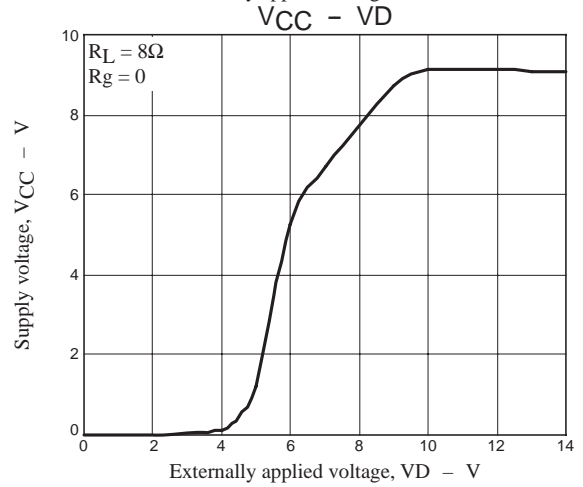
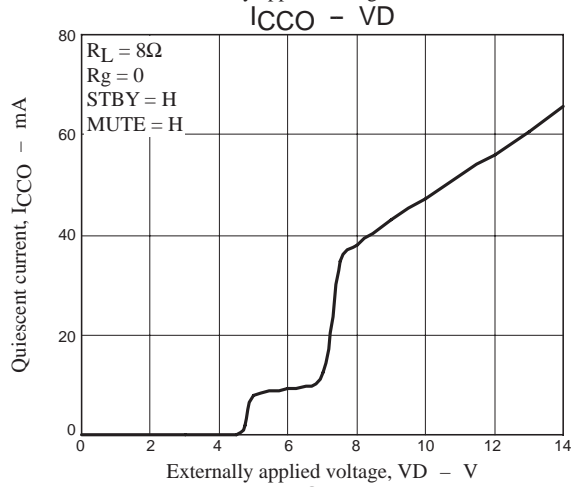
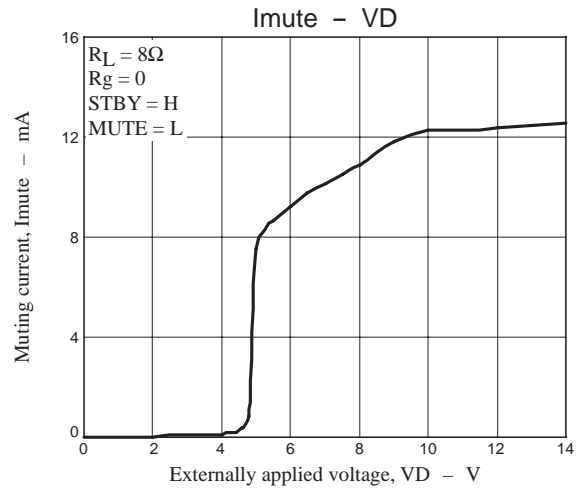
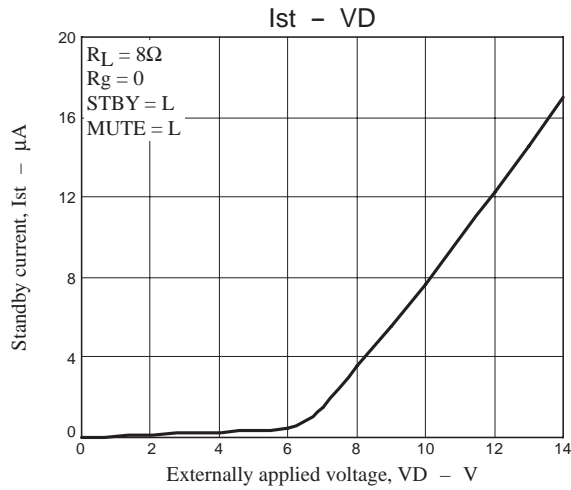

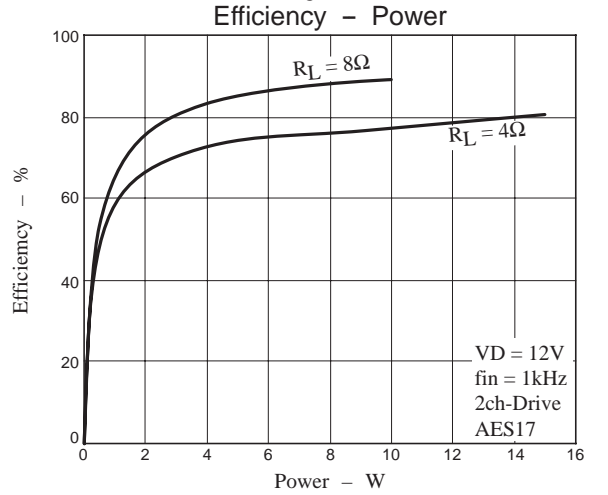
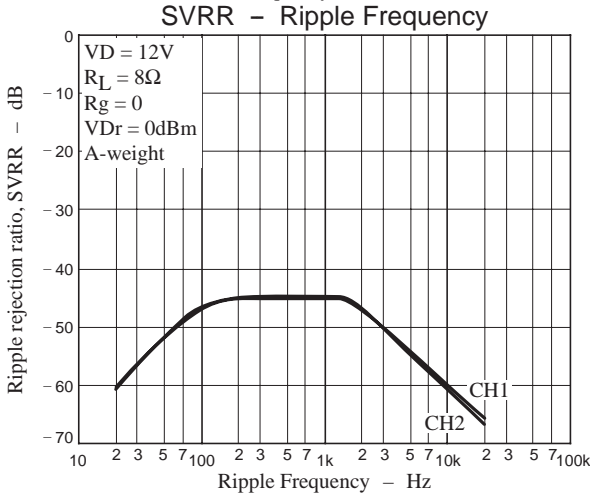
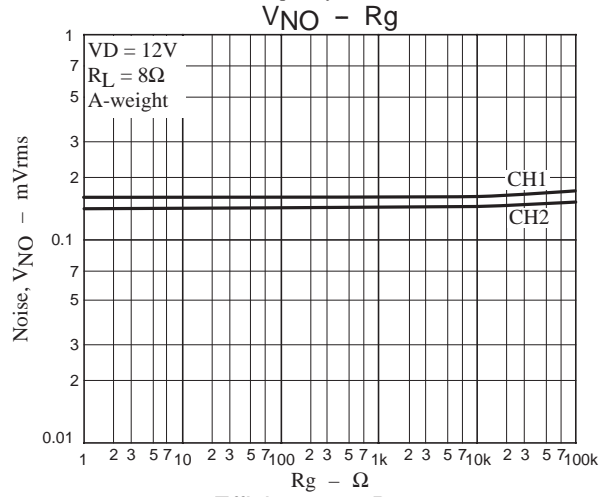
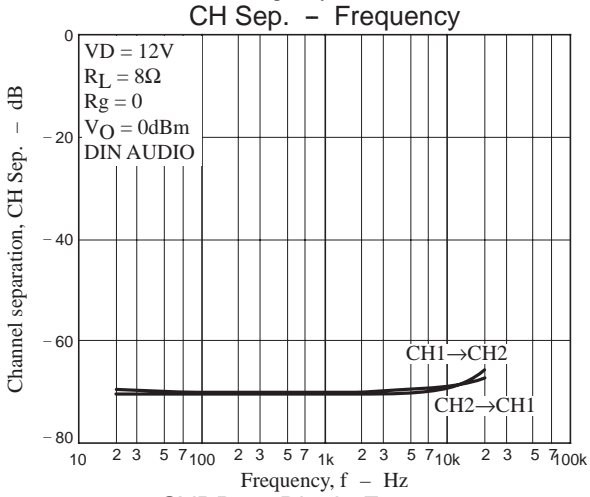
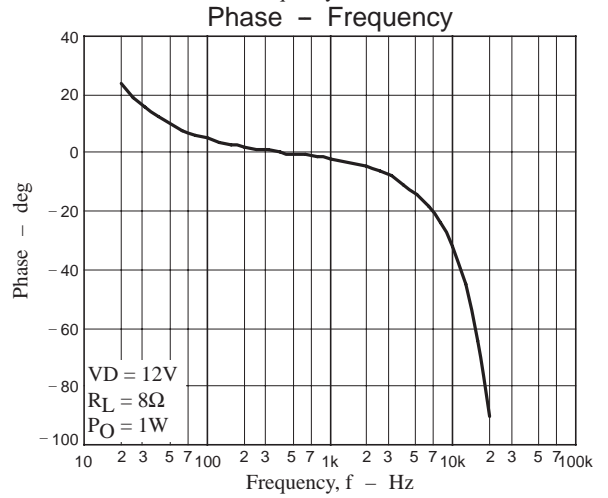
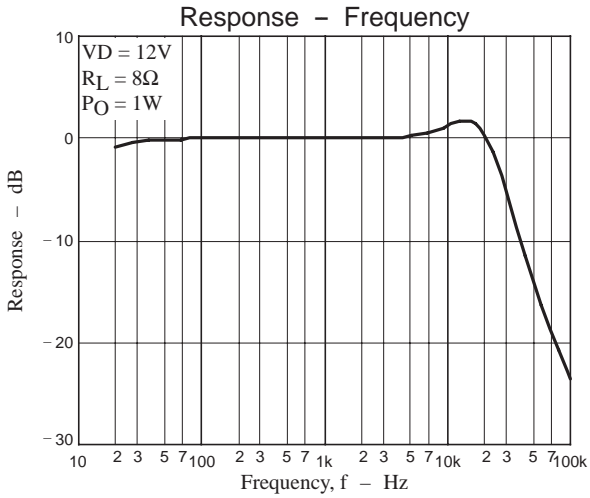
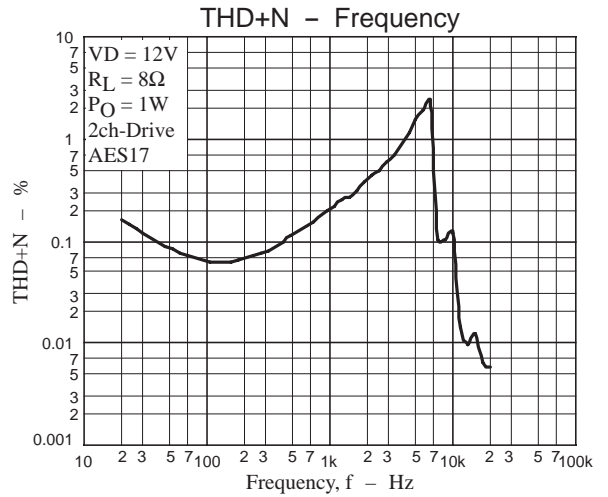
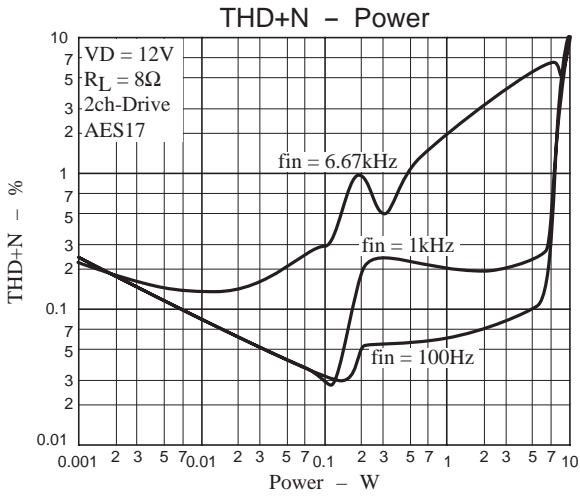

# LV4901H

## Headphone amplifier block characteristics

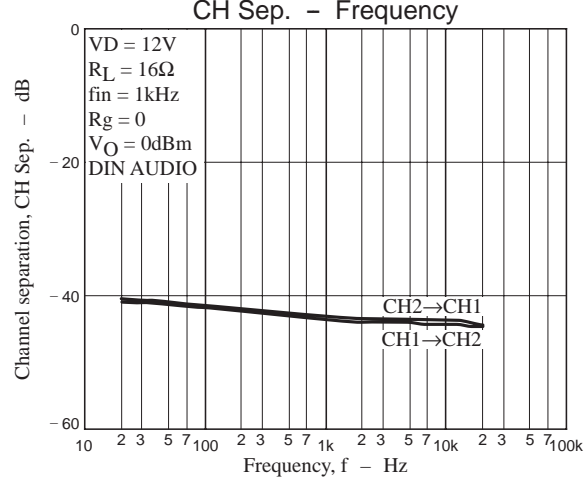
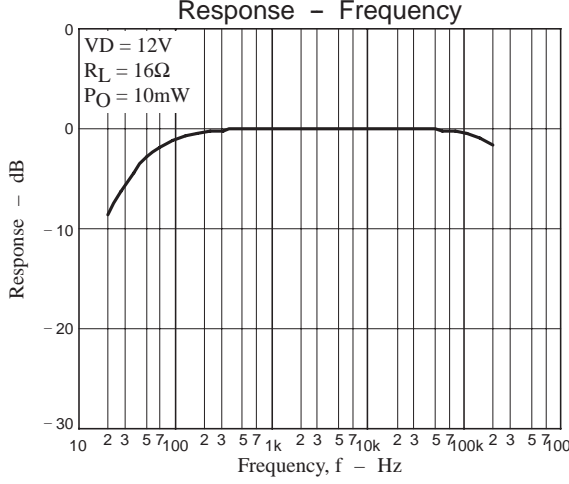
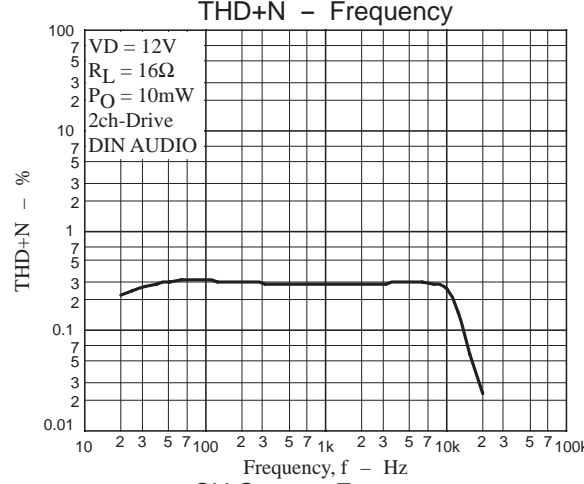
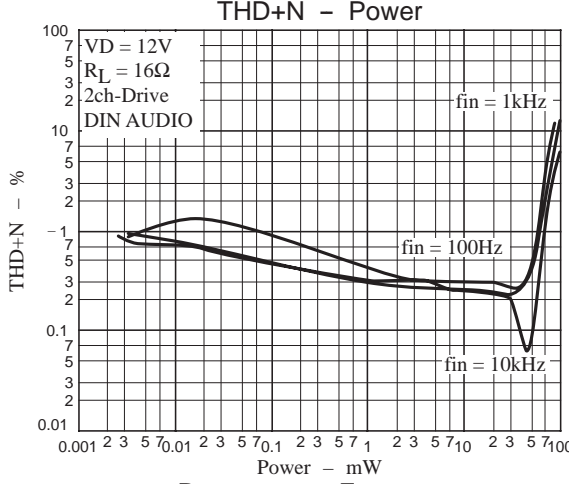
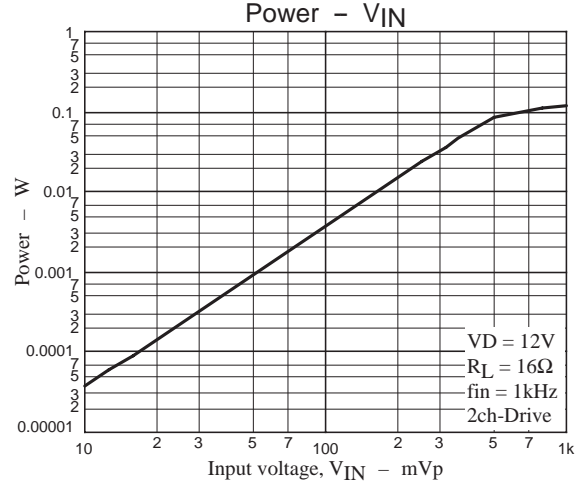
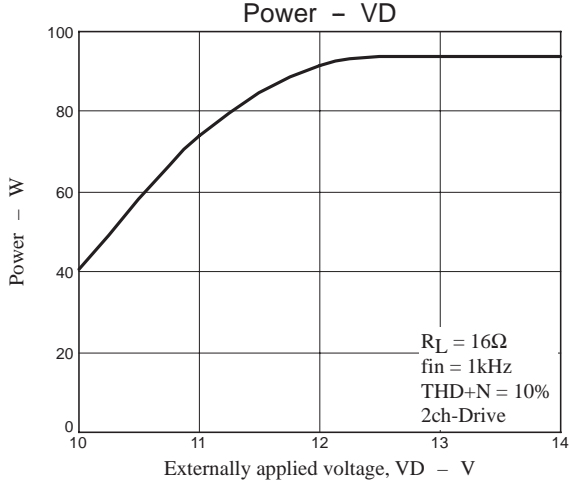
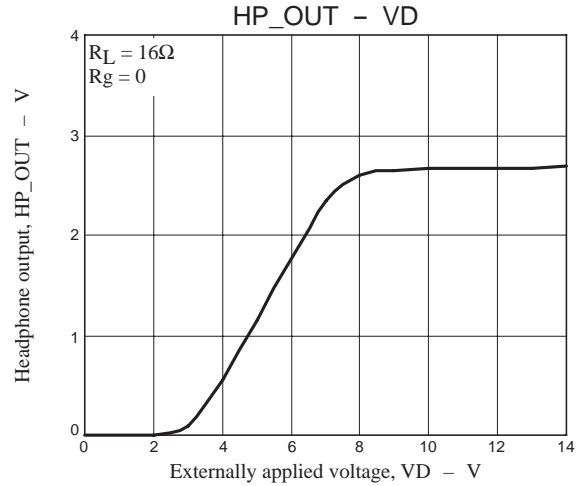
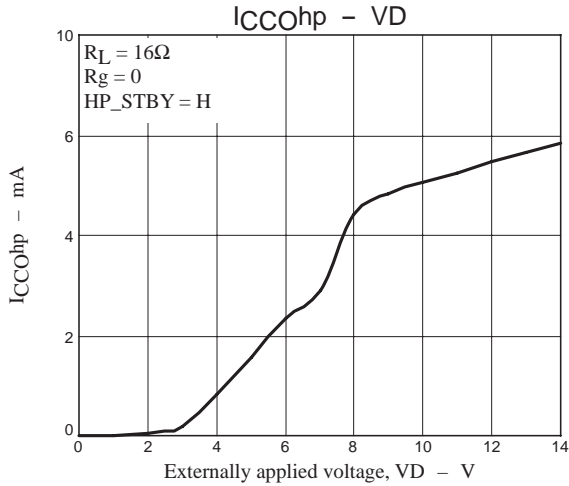

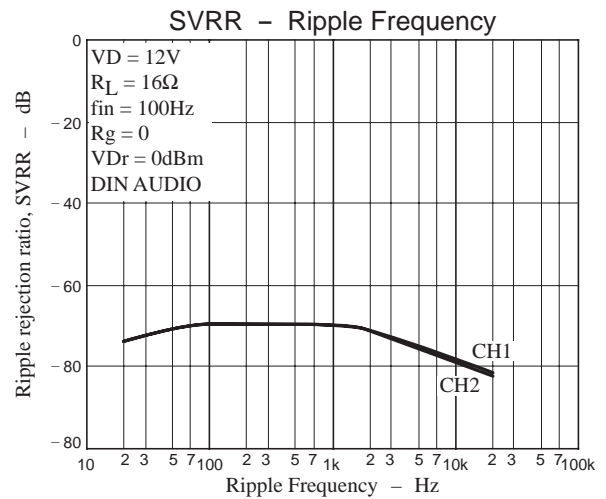
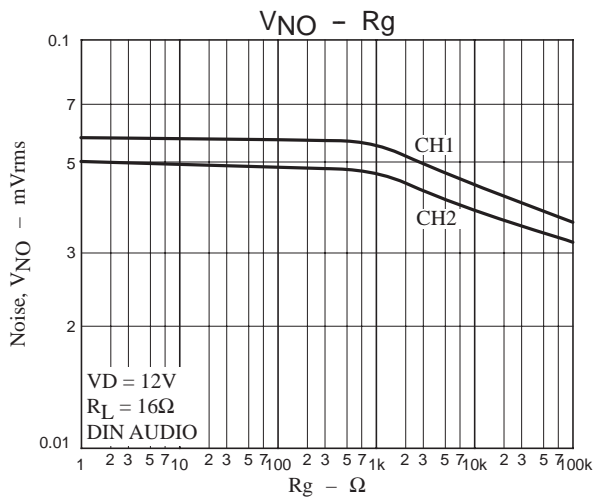

■ SANYO Semiconductor Co.,Ltd. assumes no responsibility for equipment failures that result from using products at values that exceed, even momentarily, rated values (such as maximum ratings, operating condition ranges, or other parameters) listed in products specifications of any and all SANYO Semiconductor Co.,Ltd. products described or contained herein.

■ SANYO Semiconductor Co.,Ltd. strives to supply high-quality high-reliability products, however, any and all semiconductor products fail or malfunction with some probability. It is possible that these probabilistic failures or malfunction could give rise to accidents or events that could endanger human lives, trouble that could give rise to smoke or fire, or accidents that could cause damage to other property. When designing equipment, adopt safety measures so that these kinds of accidents or events cannot occur. Such measures include but are not limited to protective circuits and error prevention circuits for safe design, redundant design, and structural design.

■ In the event that any or all SANYO Semiconductor Co.,Ltd. products described or contained herein are controlled under any of applicable local export control laws and regulations, such products may require the export license from the authorities concerned in accordance with the above law.

■ No part of this publication may be reproduced or transmitted in any form or by any means, electronic or mechanical, including photocopying and recording, or any information storage or retrieval system, or otherwise, without the prior written consent of SANYO Semiconductor Co.,Ltd.

■ Any and all information described or contained herein are subject to change without notice due to product/technology improvement, etc. When designing equipment, refer to the "Delivery Specification" for the SANYO Semiconductor Co.,Ltd. product that you intend to use.

■ Information (including circuit diagrams and circuit parameters) herein is for example only; it is not guaranteed for volume production.

■ Upon using the technical information or products described herein, neither warranty nor license shall be granted with regard to intellectual property rights or any other rights of SANYO Semiconductor Co.,Ltd. or any third party. SANYO Semiconductor Co.,Ltd. shall not be liable for any claim or suits with regard to a third party's intellectual property rights which has resulted from the use of the technical information and products mentioned above.

This catalog provides information as of July, 2008. Specifications and information herein are subject to change without notice.