

INTRODUCTION:

Adam Tech RT1 relays are modern, low profile, signal level relays offered in an ultra small package with SMT terminals and are available with coil voltages from 5-48VDC. These 2 form C relays are designed for all low signal applications such as test equipment, security equipment and medical equipment.

FEATURES:

- 1 Amp switching capability
- Low profile .192" (4.9mm)
- Low coil power of 140mw
- Tape and Reel packaging

SPECIFICATIONS:

Electrical:

Contact arrangement: 2 Form C

Contact material: Gold clad, Silver alloy

Contact Rating (Resistive load): 0.5A @ 125V AC
1A @ 30V DC

Max. Switching Voltage: 120V AC / 30V DC

Max. Switching Power: 62VA / 30W

Contact resistance: 100 mΩ max. Initial

Insulation resistance: 100 MΩ min. @ 500V DC

Dielectric withstanding voltage:

Between Coil & Contact: 500V AC 50/60Hz for 1 min.

Between Contacts: 1000V AC 50/60Hz for 1 min.

Operating time: 6 ms max.

Release time: 4 ms max.

Electrical Life: 100,000 Operations (at rated load)

MECHANICAL:

Vibration resistance (Endurance): 1.5mm Double Amplitude 10-55Hz

Shock resistance: 10G min.

Mechanical Life: 10,000,000 Operations (no load)

TEMPERATURE RATING:

Ambient temperature: -40°C to +85°C

PACKAGING:

Anti-ESD plastic tubes

SAFETY AGENCY APPROVALS:

cUL Recognized File No. E305638



ORDERING INFORMATION LOW PROFILE SMT SIGNAL RELAY

RT1	12
SERIES INDICATOR RT1 = Low Profile SMT Signal Relay	COIL VOLTAGE 5 = 5V DC 6 = 6V DC 12 = 12V DC 24 = 24V DC 48 = 48V DC



RT1 SERIES

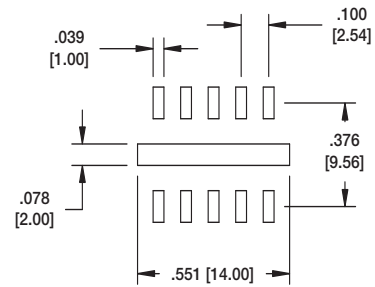
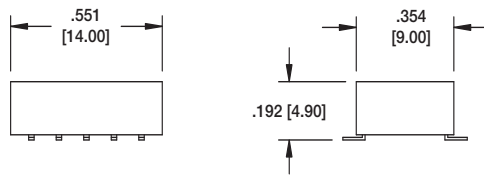

Recommended PCB Layout

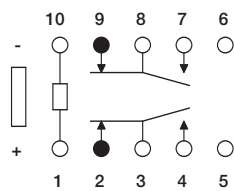

SCHEMATIC



RT1-5

Nominal Voltage V DC	Pick-up Voltage V DC (max.)	Drop-out Voltage V DC (min.)	Nominal Operating Current mA (±10%)	Coil Resistance (±10%)	Nominal Operating Power mW	Max allowable Voltage V DC
5	3.75	0.5	28.1	178	140	7.5
6	4.5	0.6	23.3	257	140	9
12	9	1.2	11.7	1,028	140	18
24	18	2.4	8.3	2,880	200	36
48	36	4.8	6.3	7,680	300	57.6

INTRODUCTION:

Adam Tech RT2 relays are small signal level relays whose footprint matches a standard 16 pin DIP socket and are available with coil voltages from 5~48VDC. These 2 form C relays are designed for all signal applications up to 2 amps, such as security equipment, test equipment and medical equipment

FEATURES:

High sensitivity: 200 mW nominal operating power.
2 Amp switching capability
Power consumption of 200mW
High mounting density on P.C.board by small size and light weight.
Sealed construction.

SPECIFICATIONS:**ELECTRICAL:**

Contact arrangement: 2 Form C
Contact material: Gold clad, Silver Alloy
Contact Rating (Resistive load): 1A @ 120V AC
2A @ 30V DC
Max. Switching Voltage: 120V AC / 30V DC
Max. Switching Power: 100VA / 60W
Contact resistance: 100 mΩ max. Initial
Insulation resistance: 100 MΩ min. @ 500V DC
Dielectric withstanding voltage:
Between Coil & Contact: 500V AC 50/60Hz for 1 min.
Between Contacts: 1000V AC 50/60Hz for 1 min.
Operating time: 6 ms max.
Release time: 4 ms max.
Electrical Life: 100,000 Operations (at rated load)

MECHANICAL:

Vibration resistance (Endurance): 1.5mm Double Amplitude 10-55Hz
Shock resistance: 10G min.
Mechanical Life: 10,000,000 Operations (no load)

TEMPERATURE RATING:

Ambient temperature: -40°C to +85°C

PACKAGING:

Anti-ESD plastic tubes
Tape & Reel

SAFETY AGENCY APPROVALS:

cUL Recognized File No. E305638

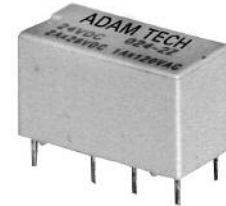
**ORDERING INFORMATION**
SIGNAL RELAY**RT2****SERIES INDICATOR**
RT2 = Signal Relay**12****COIL VOLTAGE**
5 = 5V DC
6 = 6V DC
12 = 12V DC
24 = 24V DC
48 = 48V DC

RT2 SERIES

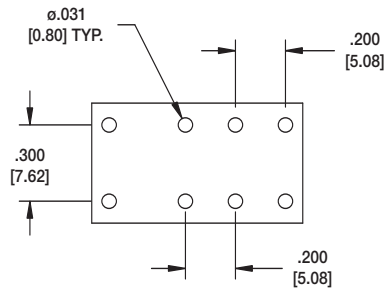
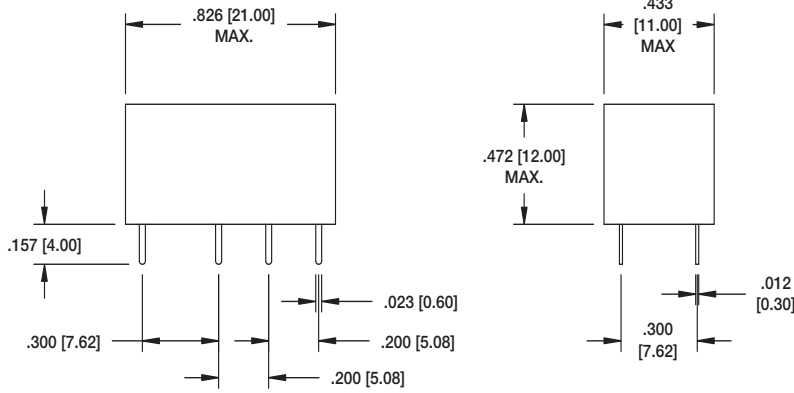

Recommended PCB Layout

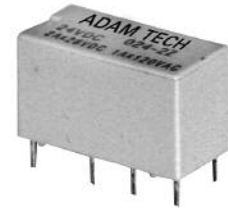

RT2-24

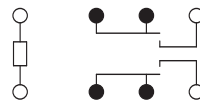

Schematic

Nominal Voltage V DC	Pick-up Voltage V DC (max.)	Drop-out Voltage V DC (min.)	Nominal Operating Current mA ($\pm 10\%$)	Coil Resistance ($\pm 10\%$)	Nominal Operating Power mW	Max allowable Voltage V DC
5	3.5	0.5	40	125	200	10
6	4.2	0.6	33.3	180	200	12
12	8.4	1.2	16.7	720	200	24
24	16.8	2.4	8.3	2,880	200	48
48	33.6	4.8	6.3	7,680	300	86

INTRODUCTION:

Adam Tech RPS relays are modern PCB low power relays. Sometimes known as 'Sugar Cube' relays, these small relays can switch loads up to 10 amps. They are available in 1 form A, and 1 form C contact formats within a sealed package. These relays are popular in applications such as small appliances, vending machines, and office equipment.

FEATURES:

10 Amp switching capability
Power consumption of 360mW
Sealed construction.

SPECIFICATIONS:

ELECTRICAL:

Contact arrangement: 1 Form A & 1 Form C
Contact material: Silver Alloy
Contact Rating (Resistive load): 7A and 10A @ 250V AC
10A @ 30V DC
Max. Switching Voltage: 250V AC / 30V DC
Max. Switching Power: 2500VA / 300W
Contact resistance: 50 mΩ max. Initial
Insulation resistance: 100 MΩ min. @ 500V DC
Dielectric withstanding voltage:
Between Coil & Contact: 1500V AC 50/60Hz for 1 min.
Between Contacts: 1000V AC 50/60Hz for 1 min.
Operating time: 10 ms max.
Release time: 5 ms max.
Electrical Life: 100,000 Operations (at rated load)

MECHANICAL:

Vibration resistance (Endurance): 1.5mm Double Amplitude 10-55Hz
Shock resistance: 10G min.
Mechanical Life: 10,000,000 Operations (no load)

TEMPERATURE RATING:

Ambient temperature: -40°C to +85°C

PACKAGING:

Anti-ESD plastic trays or tubes

SAFETY AGENCY APPROVALS:

cUL Recognized File No. E305638

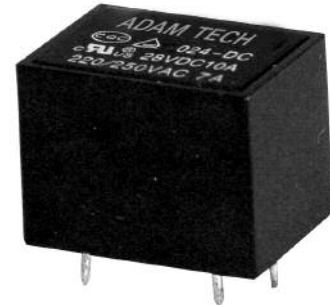

ORDERING INFORMATION MINIATURE POWER RELAY

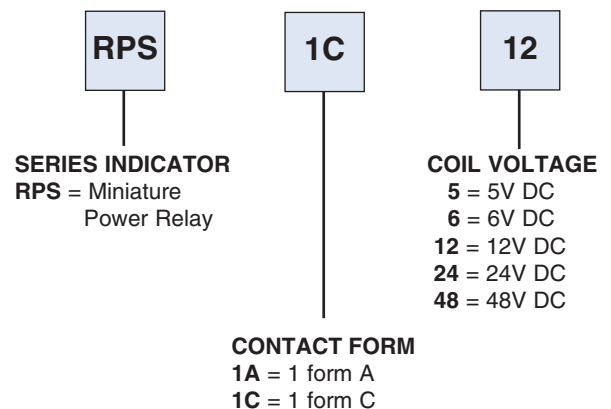

RPS-1A-X

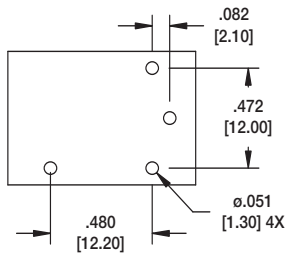
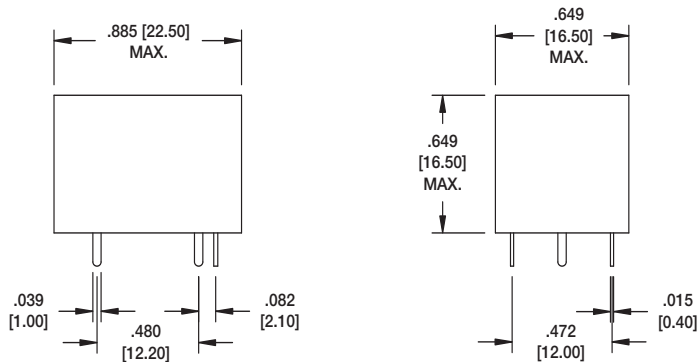

**Recommended PCB Layout
1 Form A**

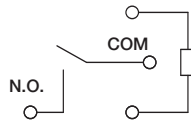

**Schematic
1 Form A**

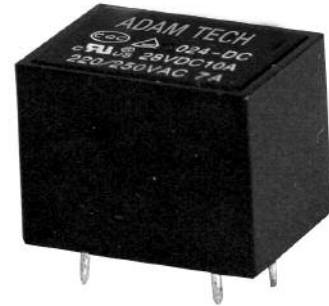

RPS-1A-24

RPS-1C-X

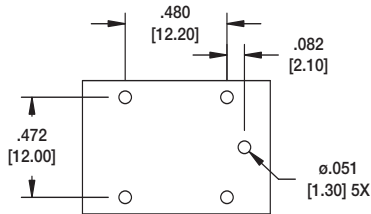

**Recommended PCB Layout
1 Form C**

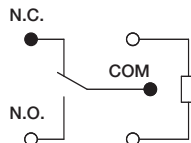

**Schematic
1 Form C**

Nominal Voltage V DC	Pick-up Voltage V DC (max.)	Drop-out Voltage V DC (min.)	Nominal Operating Current mA (±10%)	Coil Resistance (±10%)	Nominal Operating Power mW	Max allowable Voltage V DC
5	3.5	0.5	72	69.4	360	130%V of nominal Voltage
6	4.2	0.6	60	100		
12	8.4	1.2	30	400		
24	16.8	2.4	15	1,600		
48	33.6	4.8	7.5	6,400		

INTRODUCTION:

Adam Tech RPM relays are modern PCB mount medium power relays. These small relays can switch loads up to 10 amps. They are available in four different contact formats and are contained in a sealed package, these relays are perfect for applications such as home appliances, office equipment, DVDs, and microwave ovens.

FEATURES:

10 Amp Switching capability
Power consumption of 530mW nominal
Sealed construction

SPECIFICATIONS:

ELECTRICAL:

Contact arrangement: 1 Form A, 1 Form C / 2 Form A & 2 Form C
Contact material: Silver Alloy
Contact Rating (Resistive load): 10A @ 250V AC
10A @ 30V DC
Max. Switching Voltage: 250V AC / 30V DC
Max. Switching Power: 2500VA / 300W
Contact resistance: 50 mΩ max. Initial
Insulation resistance: 1000 MΩ min. @ 500V DC
Dielectric withstanding voltage:
Between Coil & Contact: 5000V AC 50/60Hz for 1 min.
Between Contacts: 1000V AC 50/60Hz for 1 min.
Operating time: 15 ms max.
Release time: 10 ms max.
Electrical Life: 100,000 Operations (at rated load)

MECHANICAL:

Vibration resistance (Endurance): 1.5mm Double Amplitude 10-55Hz
Shock resistance: 10G min.
Mechanical Life: 10,000,000 Operations (no load)

TEMPERATURE RATING:

Ambient temperature: -40°C to +85°C

PACKAGING:

Anti-ESD plastic trays or tubes

SAFETY AGENCY APPROVALS:

cUL Recognized File No. E305638



ORDERING INFORMATION POWER RELAY

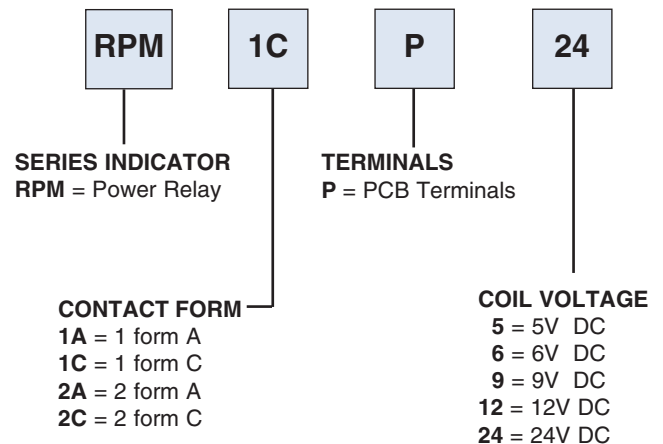

RPM SERIES

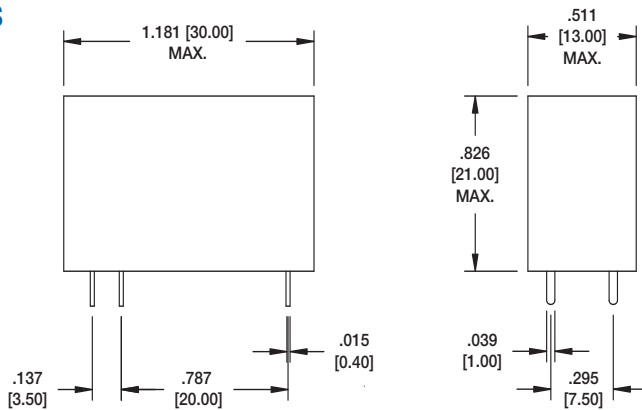

RPM-1A-P-12

RPM-1A-P-XX

RPM-1C-P-XX

RPM-2A-P-XX

RPM-2C-P-XX

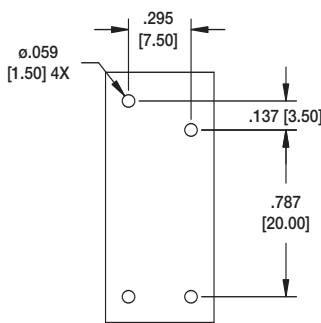

Recommended PCB Layout
1 Form A

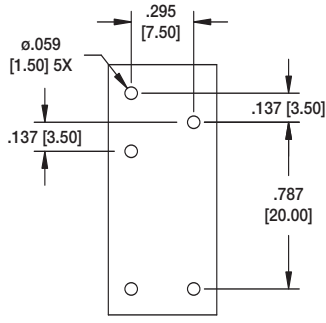

Recommended PCB Layout
1 Form C

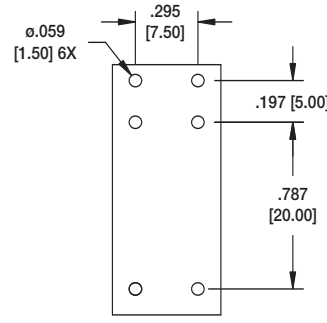

Recommended PCB Layout
2 Form A

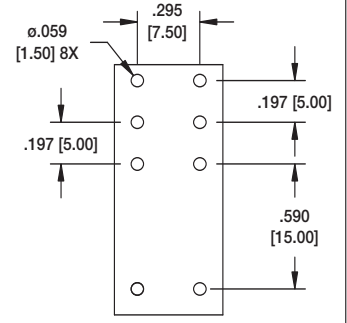

Recommended PCB Layout
2 Form C

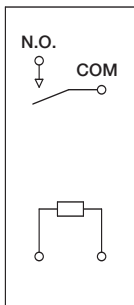

Schematic
1 Form A

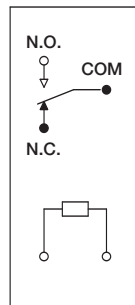

Schematic
1 Form C

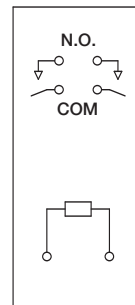

Schematic
2 Form A

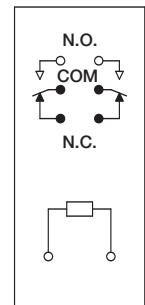

Schematic
2 Form C

Nominal Voltage V DC	Pick-up Voltage V DC (max.)	Drop-out Voltage V DC (min.)	Nominal Operating Current mA (±10%)	Coil Resistance (±10%)	Nominal Operating Power mW	Max allowable Voltage V DC
5	3.5	0.5	106	47	530	130%V of nominal Voltage @ 60 C
6	4.2	0.6	88	68		
9	6.3	0.9	58	155		
12	8.4	1.2	44	270		
24	16.8	2.4	22	1,100		
						120%V of nominal Voltage @ 85 C

INTRODUCTION:

Adam Tech RG1 relays are small size general purpose relays available in four different contact formats with either AC or DC activated coils. These relays are available with PCB, Solder, or Quick Connect terminals and a Flange Mount cover option. Rated up to 15 amps, they are ideal for applications such as industrial control equipment, office machines, and medical equipment.

FEATURES:

Contact ratings up to 15 amps
AC and DC coils available
Top mount flange option

SPECIFICATIONS:

ELECTRICAL:

Contact arrangements: 1 Form A & 1 Form C / 2 Form A & 2 Form C
Contact material: Silver Alloy
Contact Rating (Resistive load): 15A @ 250V AC
15A @ 30V DC
Max. Switching Voltage: 250V AC / 30V DC
Max. Switching Power: 3750VA / 450W
Contact resistance: 50 mΩ max. Initial
Insulation resistance: 500 MΩ min. @ 500V DC
Dielectric withstanding voltage:
Between Coil & Contact: 2500V AC 50/60Hz for 1 min.
Between Contacts: 1500V AC 50/60Hz for 1 min.
Operating time: 25 ms max.
Release time: 25 ms max.
Electrical Life: 100,000 Operations (at rated load)

MECHANICAL:

Vibration resistance (Endurance): 1.0mm double amplitude 10-55Hz
Shock resistance: 10G min.
Mechanical Life: 10,000,000 Operations (no load)

TEMPERATURE RATING:

Ambient temperature: -45°C to +85°C

PACKAGING:

Anti-ESD plastic trays

SAFETY AGENCY APPROVALS:

cUL Recognized File No. E305638

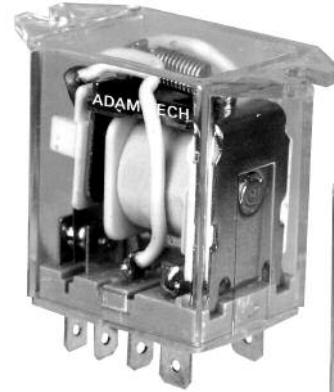

RG1-2C-QC-110VAC-F

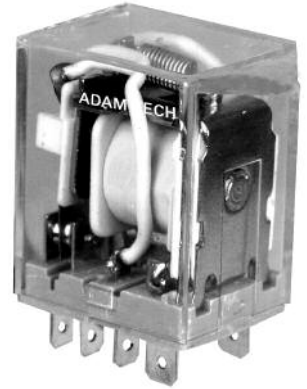

RG1-2C-QC-110VAC

**ORDERING INFORMATION
GENERAL PURPOSE RELAY**

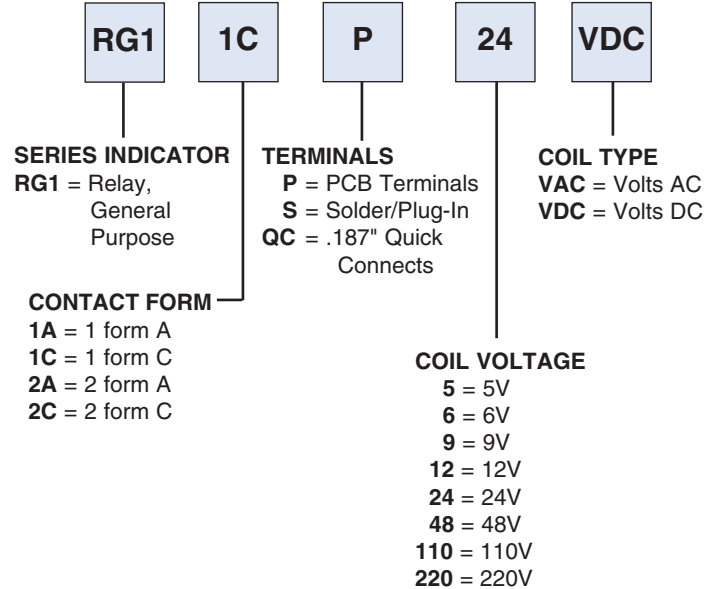

OPTION:

Add designator(s) to end of part number
F = Top Mount flange

RG1 SERIES

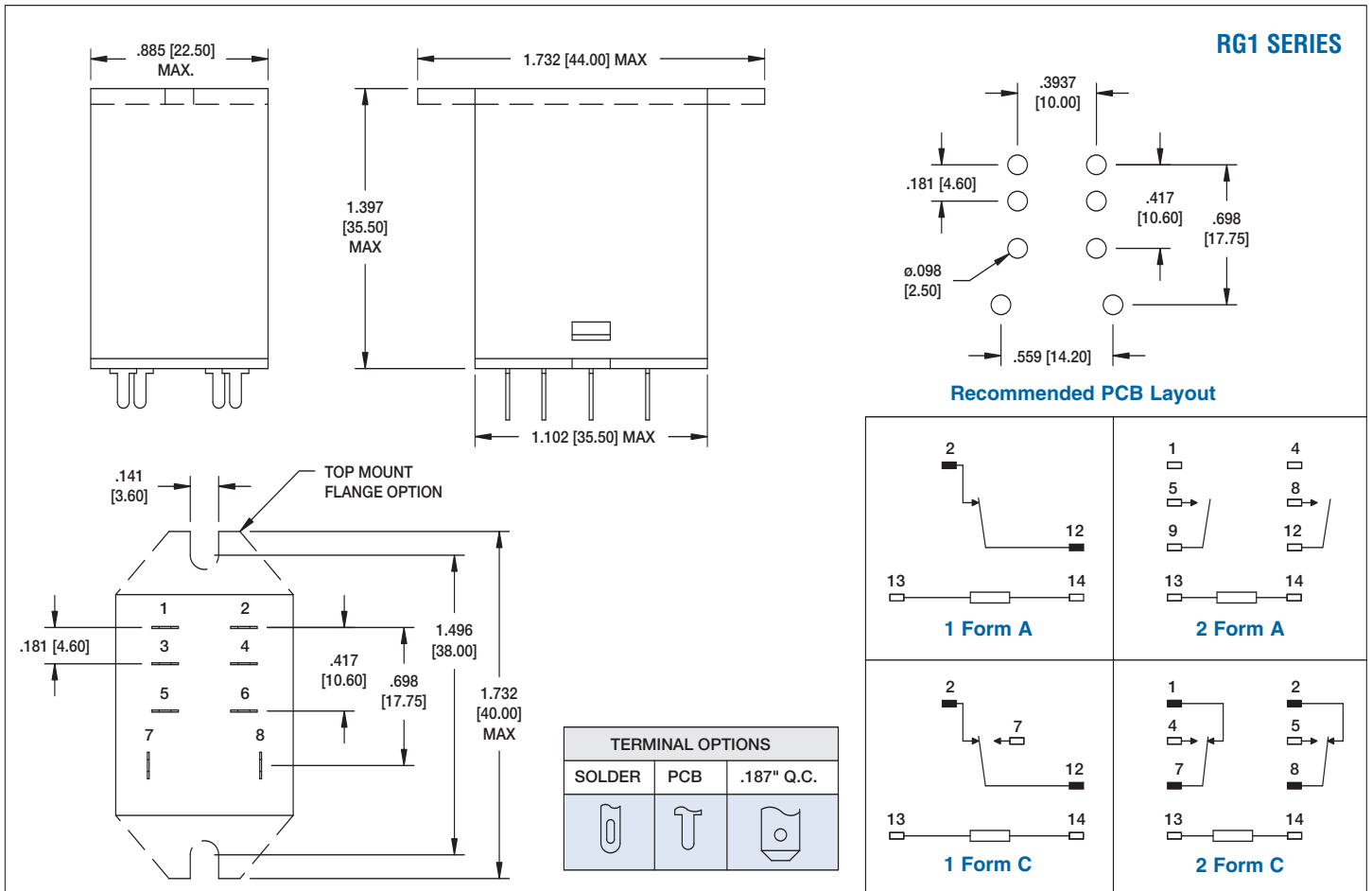

DC Types @ 20° C

Nominal Voltage V DC	Pick-up Voltage V DC (max.)	Drop-out Voltage V DC (min.)	Nominal Operating Current mA (±10%)	Coil Resistance (±10%)	Operating Power W		Max allowable Voltage V DC
					Nominal	Minimum	
6	4.8	0.6	150	40	0.9	0.58	6.6
12	9.6	1.2	75	160	0.9	0.58	13.2
24	19.2	2.4	37	640	0.9	0.58	26.4
48	38.4	4.8	18.5	2,560	0.9	0.58	52.8
110/120	88	11	10	13,400	0.9	0.58	121

AC Types (50/60 Hz) @ 60 Hz, 20° C

Nominal Voltage V AC	Pick-up Voltage V DC (max.)	Drop-out Voltage V DC (min.)	Nominal Operating Current mA (±10%)	Coil Resistance (±10%)	Operating Power VA	Max allowable Voltage V DC
6	4.8	1.2	220	10	Nominal 1.20 Minimum 0.77	6.6
12	9.6	2.4	110	40		13.2
24	19.2	4.8	60	160	Minimum 0.77	26.4
48	38.4	9.6	30	650		52.8
110/120	88	22	13.5 / 14.5	3,400		132
220/240	176	44	6.0 / 6.5	1,360		264

INTRODUCTION:

Adam Tech RG2 Relays are small general purpose relays available in eight different contact formats with either AC or DC coils and are available with PCB or Solder terminals. These relays are ideal for applications such as industrial control equipment, office machines, and medical equipment

FEATURES:

Contact ratings up to 7 amps
AC and DC coils available
PCB & Solder Plug-in terminals

SPECIFICATIONS:

ELECTRICAL:

Contact arrangement: 1 to 4 Pole, Form A & C
Contact material: Silver Alloy
Contact Rating (Resistive load):
1, 2 & 3 Pole: 7A @ 250V AC
7A @ 30V DC
4 Pole: 5A @ 250V AC
5A @ 30V DC
Max. Switching Voltage: 250V AC / 30V DC
Max. Switching Power: 1540VA, 210W
Contact resistance: 100 mΩ max. Initial
Insulation resistance: 1000 MΩ min. @ 500V DC
Dielectric withstanding voltage:
Between Coil & Contact: 1500V AC 50/60Hz for 1 min.
Between Contacts: 1000V AC 50/60Hz for 1 min.
Operating time: 25 ms max.
Release time: 25 ms max.
Electrical Life: 100,000 Operations (at rated load)

MECHANICAL:

Vibration resistance (Endurance): 1.0mm Double Amplitude 10-55Hz
Shock resistance: 10G min.
Mechanical Life: 10,000,000 Operations (no load)

TEMPERATURE RATING:

Ambient temperature: -45°C to +85°C

PACKAGING:

Anti-ESD plastic trays

SAFETY AGENCY APPROVALS:

cUL Recognized File No. E305638



RG2-2C-S-24VDC

ORDERING INFORMATION
GENERAL PURPOSE RELAY

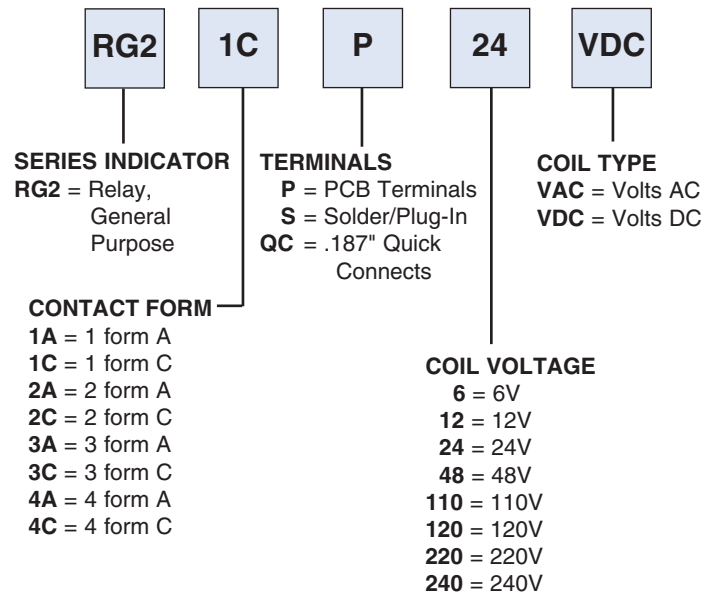

OPTION:

Add designator(s) to end of part number
F = Top Mount flange



RG2 SERIES

TOP MOUNT FLANGE OPTION

Recommended PCB Layout

RG2-1A	RG2-2A	RG2-3A	RG2-4A
RG2-1C	RG2-2C	RG2-3C	RG2-4C

DC Types @ 20C

Nominal Voltage V DC	Pick-up Voltage V DC (max.)	Drop-out Voltage V DC (min.)	Nominal Operating Current mA (±10%)	Coil Resistance (±10%)	Operating Power W		Max allowable Voltage V DC
					Nominal	Minimum	
6	4.8	0.6	150	40	0.9	0.58	6.6
12	9.6	1.2	75	160	0.9	0.58	13.2
24	19.2	2.4	37	640	0.9	0.58	26.4
48	38.4	4.8	19	2560	0.9	0.58	52.8
110/120	88	11	8.2	13,400	1.0	0.64	132

AC Types (50/60 Hz) @ 60 Hz, 20C

Nominal Voltage V AC	Pick-up Voltage V DC (max.)	Drop-out Voltage V DC (min.)	Nominal Operating Current mA (±10%)	Coil Resistance (±10%)	Operating Power VA	Max allowable Voltage V DC
6	4.8	1.2	200	10	Nominal 1.20 Minimum 0.77	6.6
12	9.6	2.4	100	40		13.2
24	19.2	4.8	60	160		26.4
48	38.4	9.6	30	650		52.8
110/120	96	22	13.5 / 14.5	3400		132
220/240	176	44	6.0 / 6.5	1360		264

INTRODUCTION:

Adam Tech RPL relays are high power, modern relays, available in industry standard packages and can switch loads up to 30 amps. Available in both a PCB package and a combination PCB/Quick Connect terminal package, these relays are designed for applications such as Spa/Pool controls, HVAC, and large appliances.

FEATURES:

30 Amp Switching capability
PCB and PCB/Top mount packages
Industry Standard footprint

SPECIFICATIONS:

ELECTRICAL:

Contact arrangement: 1 Form A & 1 Form C
Contact material: Silver Alloy
Contact Rating (Resistive load): 30A @ 220V AC
30A @ 30V DC
Max. Switching Voltage: 220V AC / 30V DC
Max. Switching Power: 6600VA / 900W
Contact resistance: 50 mΩ max. Initial
Insulation resistance: 100 MΩ min. @ 500V DC
Dielectric withstanding voltage:
Between Coil & Contact: 2500V AC 50/60Hz for 1 min.
Between Contacts: 1500V AC 50/60Hz for 1 min.
Operating time: 15 ms max.
Release time: 10 ms max.
Electrical Life: 100,000 Operations (at rated load)

MECHANICAL:

Vibration resistance (Endurance): 1.5mm Double Amplitude 10-55Hz
Shock resistance: 10G min.
Mechanical Life: 10,000,000 Operations (no load)

TEMPERATURE RATING:

Ambient temperature: -55°C to +85°C

PACKAGING:

Anti-ESD plastic trays

SAFETY AGENCY APPROVALS:

cUL Recognized File No. E305638

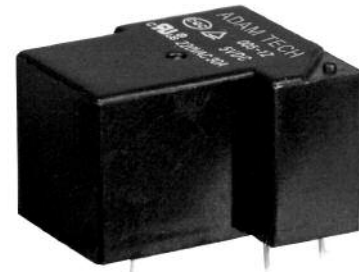

ORDERING INFORMATION POWER RELAY

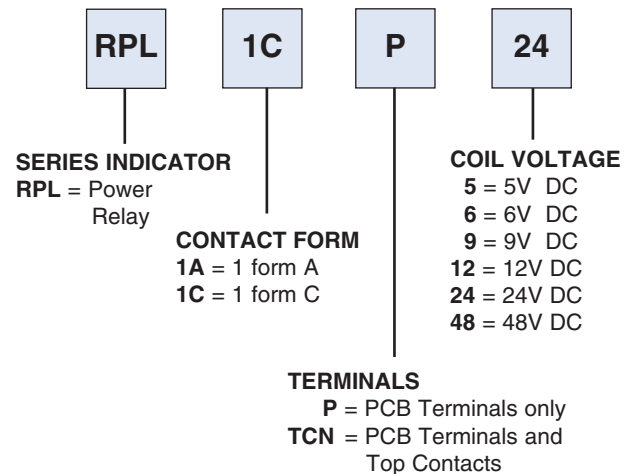

RPL SERIES

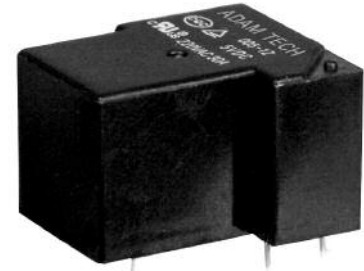
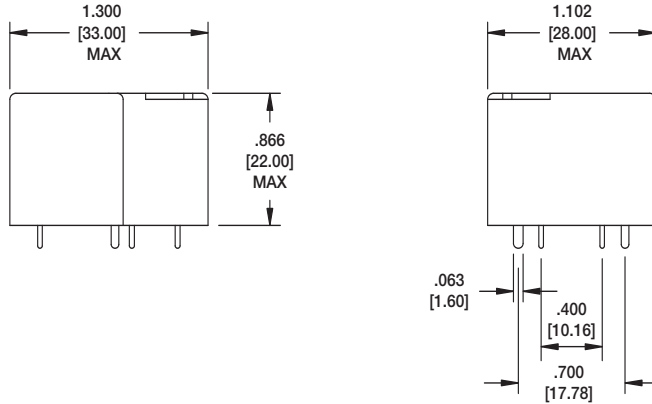

RPL-1C-P-12

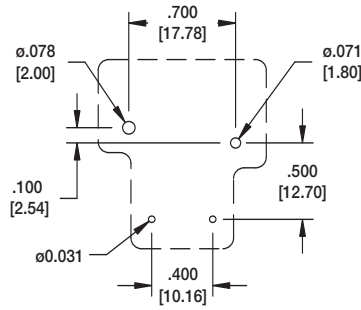

Recommended PCB Layout
1 Form A

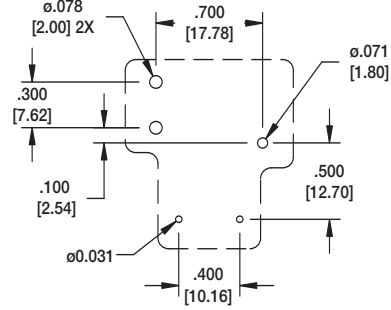

Recommended PCB Layout
1 Form C

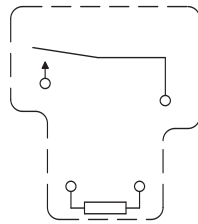

Schematic
1 Form A

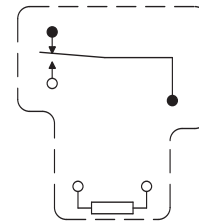

Schematic
1 Form C

Nominal Voltage V DC	Pick-up Voltage V DC (max.)	Drop-out Voltage V DC (min.)	Coil Resistance (±10%)	Nominal Operating Power mW	Max allowable Voltage V DC
5	3.75	0.5	31	900	6
6	4.5	0.6	40	900	6.6
9	6.75	0.9	101	900	10.8
12	9.0	1.2	160	900	13.2
24	18.0	2.4	640	900	26.4
48	36.0	4.8	2,560	900	52.8

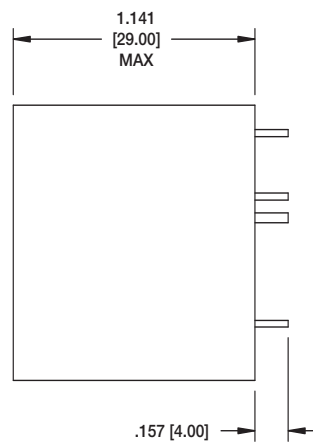
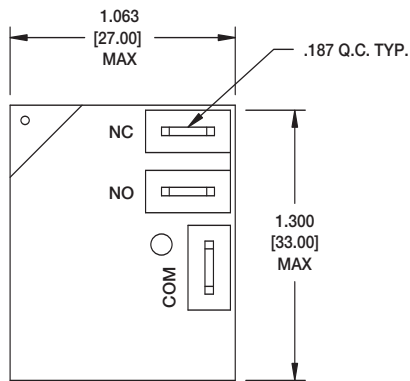

RPL SERIES (TOP CONTACTS)



RPL-1C-TCN-12

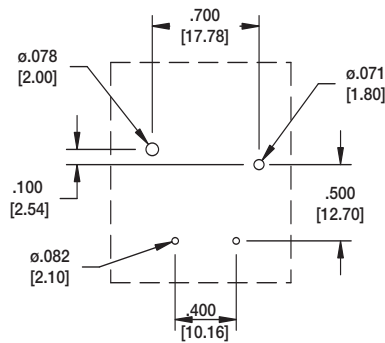

Recommended PCB Layout
1 Form A

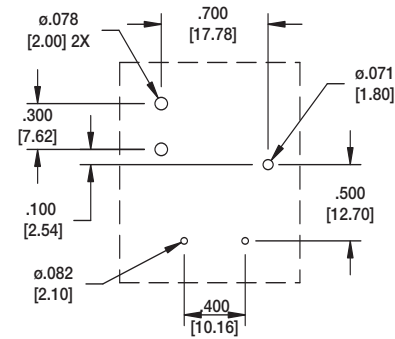

Recommended PCB Layout
1 Form C

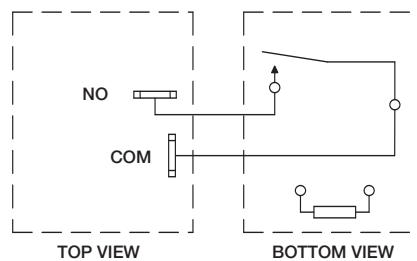

TOP VIEW

BOTTOM VIEW

Schematic
1 Form A

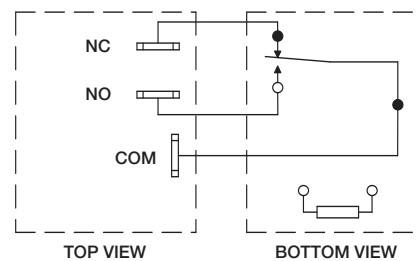

TOP VIEW

BOTTOM VIEW

Schematic
1 Form C

Nominal Voltage V DC	Pick-up Voltage V DC (max.)	Drop-out Voltage V DC (min.)	Coil Resistance (±10%)	Nominal Operating Power mW	Max allowable Voltage V DC
5	3.75	0.5	31	900	6
6	4.5	0.6	40	900	6.6
9	6.75	0.9	101	900	10.8
12	9	1.2	160	900	13.2
24	18	2.4	640	900	26.4
48	36	4.8	2,560	900	52.8

