

Nouveau Relais Statique compact

Série au pas de 22,5mm

New Solid State Relay compact size pitch 22,5mm





SIC862500
8-30VDC control
25A/400VAC output

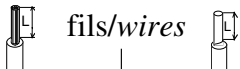

- Sortie AC synchrone : 24 - 600 VAC- 25A.
- Protection IP20.

- 24-600VAC -25A Zero-Cross AC Output.
- IP20 Protection .

Connections .

	 fils/wires	 couple serrage/torques	 tournevis/Screwdriver
control	1 x (0,14-->2,5mm ²) L = 6mm	0,6N.m	M 3 
power	1 x 6mm ² 1 x 4mm ² L = 9mm	0,6N.m	M 3 

Dimensions / Size

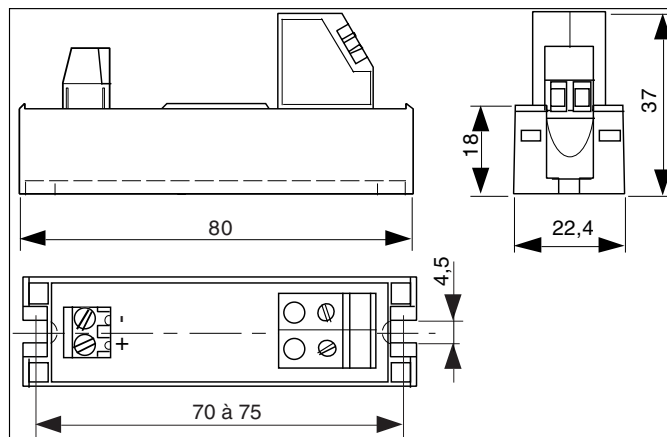

A monter sur dissipateur.
Must be used with heatsink
(see fig 2)

Application typique/Typical application

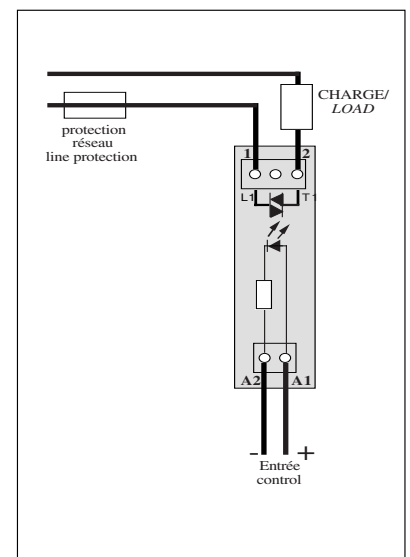

Caractéristiques de commande (à 20°C) / Control characteristics (at 20°C)

Paramètre / Parameter	Symbol	DC			Unit
		Min	Nom	Max	
Tension de commande / Control voltage	Uc	8		30	V
Courant de commande / Control current (@ Uc)	Ic	5		30	mA
Tension de relachement/Release voltage	Uc off	1			V
Résistance interne / Input internal resistor fig.1	Rc		1000		Ω
Tension inverse / Reverse voltage	Urv		30		V

Caractéristiques d'entrée-sortie (à 20°C) / Input-output characteristics (at 20°C)

Isolement entrée-sortie/Input-output isolation @500m	Ui	4000		VRMS
Isolement sortie-semelle/Output-case isolation @500m	Ui	2500		VRMS
Tension assignée Isolement/Rated impulse voltage	Uimp	4000		V

fig. 1 : Caractéristique d'entrée / Control characteristic

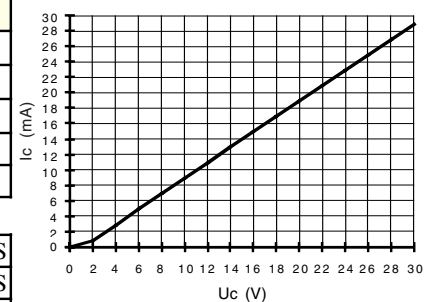

Caractéristiques générales / General characteristics

Paramètre / Parameter	Conditions	Symbol	Typ.	Unit
Poids/Weight			90	g
Plage de température de stockage / Storage temperature range			-40 / +100	°C
Plage de température de fonctionnement/Operating temperature range			-40 / +100	°C

Proud to serve you

celduc[®]
r e l a i s

Caractéristiques de sortie (à 20°C) / Output characteristics (at 20°C)

Paramètre / Parameter	Conditions	Symbol	Typ.	Unit
Tension de charge / Load voltage		Ue	400	V rms
Plage tension de fonctionnement / Operating range		Uemin-max	24-600	V rms
Tension crête / Peak voltage		Up	1200	V
Niveau de synchronisation / Synchronizing level		Usync	50	V
Tension d'amorçage / Latching voltage	Ie nom	Ua	8	V
Courant nominal AC-51/ AC-51 nominal current	(see Fig. 2)	Ie AC-51	25	A rms
Courant nominal AC-53/ AC-53 nominal current	*			
Courant de surcharge non répétitif / Non repetitive overload current	tp=10ms (Fig. 3)	I _{tsm}	250	A
Chute tension directe crête/ On state voltage drop	@ Ie nom	Vd	1,3	V
Courant de fuite état bloqué/ Off state leakage current	@Ue, 50Hz	I _{lk}	<1	mA
Courant de charge minimum / Minimum load current		Ie min	5	mA
Temps de fermeture/ Turn on time	Uc nom DC ,f=50Hz	ton max	10	ms
Temps d'ouverture/ Turn off time	Uc nom DC ,f=50Hz	toff max	10	ms
Plage de fréquence / Operating frequency range		f	0,1-440	Hz
dv/dt état bloqué / Off state dv/dt		dv/dt	500	V/μs
dI/dt maximum non répétitif/ Maximum di/dt non repetitive		di/dt	50	A/μs
I ² t (<10ms)		I ² t	312	A ² s
Conformité / Conformity	EN60947-4-x			

Fig. 2 Courbes thermiques / Thermal characteristics

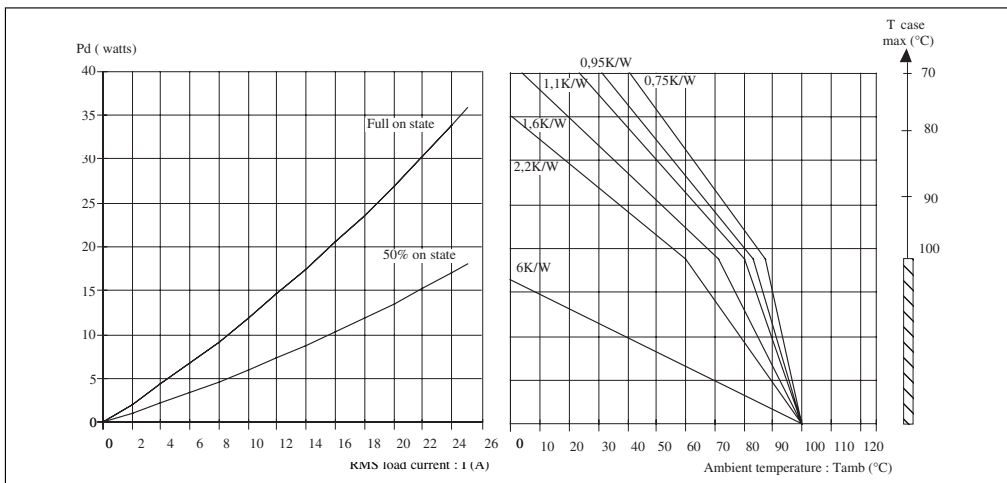

* Pour autres charges
consulter celduc
For other loads
consult celduc

Fig.3 Surcharge de courant : I_{tsm} (Apeak) = f(t) pour modèle 25A (I_{tsm}=230A)
Surge current : I_{tsm} (Apeak) = f(t) for 25A models with I_{tsm} =230A

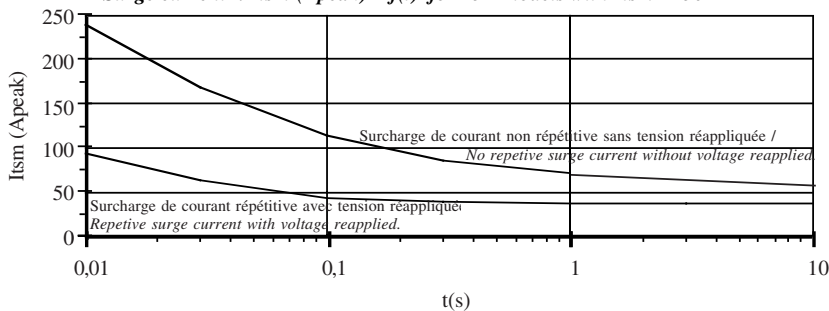

1 -I_{tsm} non répétitif sans tension réappliquée est donné pour la détermination des protections.

No repetitive I_{tsm} is given without voltage reapplied for the determination of the protection.

2 -I_{tsm} répétitif est donné pour des surcharges de courant (T_j initiale=70°C). La répétition de ces surcharges de courant diminue la durée de vie du Relais.

Repetitive I_{tsm} is given for inrush current with initial T_j = 70°C. The repetition of the surge current decrease the lifetime SSR's .

Précautions :

* Les relais à semiconducteurs ne procurent pas d'isolation galvanique entre le réseau et la charge.

Cautions :

* Semiconductor relays don't provide any galvanic insulation between the load and the mains.



ISO 9001
N° 1993/1106a

celduc[®]
r e l a i s

www.celduc.com

Rue Ampère B.P. 4 42290 SORBIERS - FRANCE E-Mail : celduc-relais@celduc.com
Fax +33 (0) 4 77 53 85 51 Service Commercial France Tél. : +33 (0) 4 77 53 90 20
Sales Dept.For Europe Tel. : +33 (0) 4 77 53 90 21 Sales Dept. Asia : Tél. +33 (0) 4 77 53 90 19