

Silicon NPN Power Transistors

2SC4662

DESCRIPTION

- With TO-220F package
- High voltage.
- High speed switching

APPLICATIONS

- For switching regulator and general purpose applications

PINNING

PIN	DESCRIPTION
1	Base
2	Collector
3	Emitter

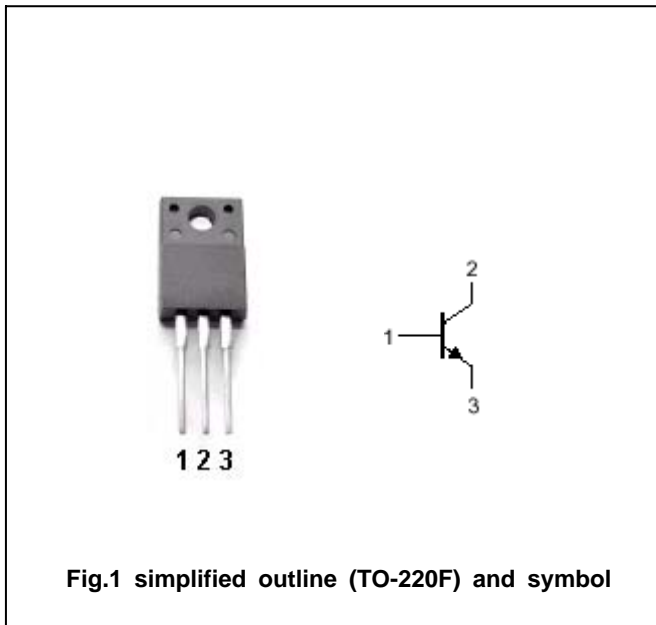

Absolute maximum ratings (Ta=25°C)

SYMBOL	PARAMETER	CONDITIONS	VALUE	UNIT
V_{CBO}	Collector-base voltage	Open emitter	500	V
V_{CEO}	Collector-emitter voltage	Open base	400	V
V_{EBO}	Emitter-base voltage	Open collector	10	V
I_C	Collector current		5	A
I_{CM}	Collector current-peak		10	A
I_B	Base current		2	A
P_C	Collector dissipation	$T_C=25^\circ\text{C}$	30	W
T_j	Junction temperature		150	$^\circ\text{C}$
T_{stg}	Storage temperature		-55~150	$^\circ\text{C}$

Silicon NPN Power Transistors

2SC4662

CHARACTERISTICS

T_j=25°C unless otherwise specified

SYMBOL	PARAMETER	CONDITIONS	MIN	TYP.	MAX	UNIT
V _{(BR)CEO}	Collector-emitter breakdown voltage	I _C =25mA ; I _B =0	400			V
V _{CEsat}	Collector-emitter saturation voltage	I _C =1.5A ; I _B =0.3A			0.5	V
V _{BEsat}	Base-emitter saturation voltage	I _C =1.5A ; I _B =0.3A			1.3	V
I _{CBO}	Collector cut-off current	V _{CB} =500V; I _E =0			100	μ A
I _{EBO}	Emitter cut-off current	V _{EB} =10V; I _C =0			100	μ A
h _{FE}	DC current gain	I _C =1.5A ; V _{CE} =4V	10		30	
C _{OB}	Output capacitance	I _E =0; V _{CB} =10V; f=1MHz		30		pF
f _T	Transition frequency	I _E =-0.3A ; V _{CE} =12V		20		MHz

Switching times

t _{on}	Turn-on time	I _C =1.5A; I _{B1} =0.15A I _{B2} =-0.3A V _{CC} =200V , R _L =133 Ω			1.0	μ s
t _s	Storage time				2.5	μ s
t _f	Fall time				0.5	μ s

Silicon NPN Power Transistors

2SC4662

PACKAGE OUTLINE

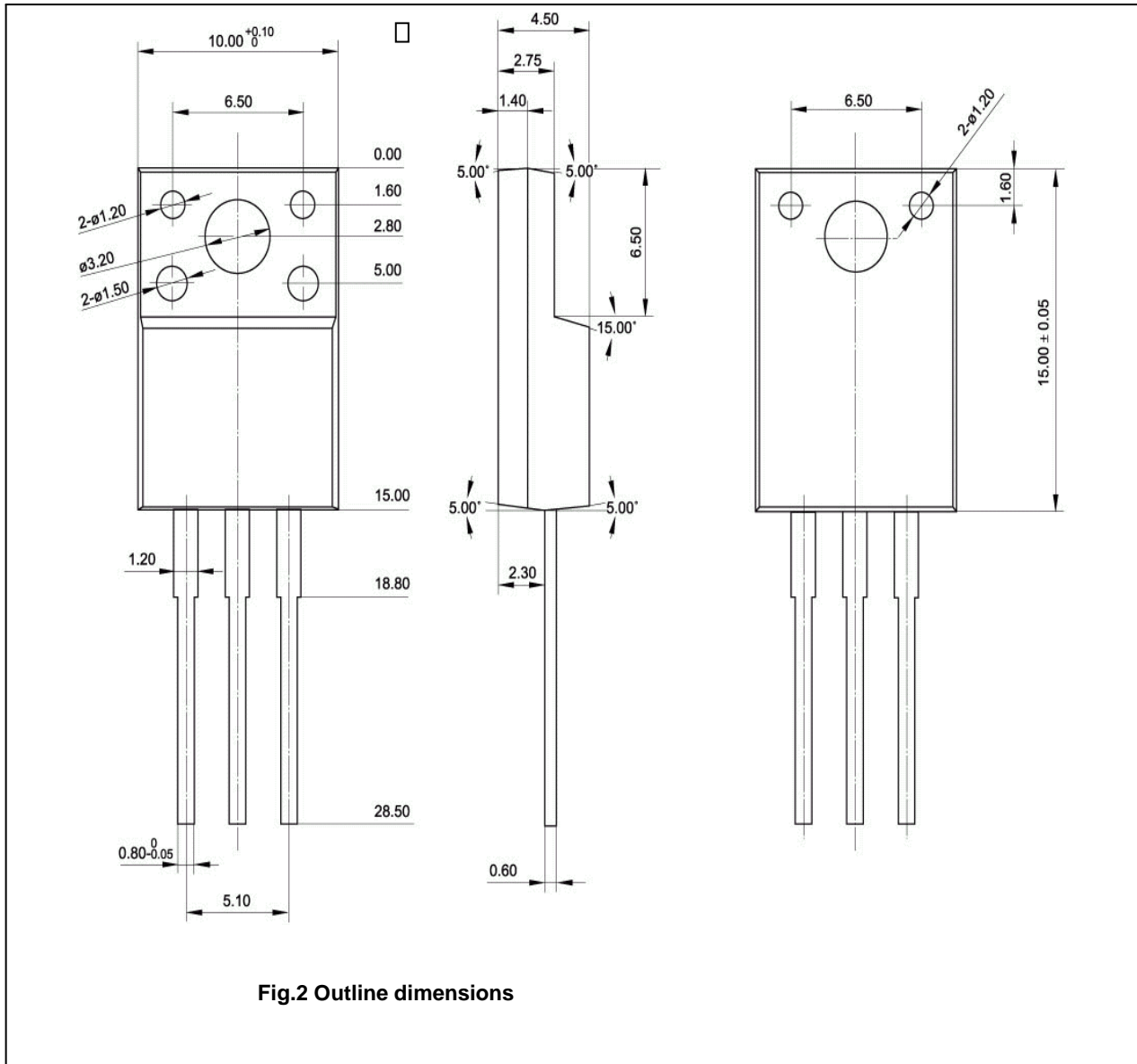

Fig.2 Outline dimensions

Silicon NPN Power Transistors

2SC4662

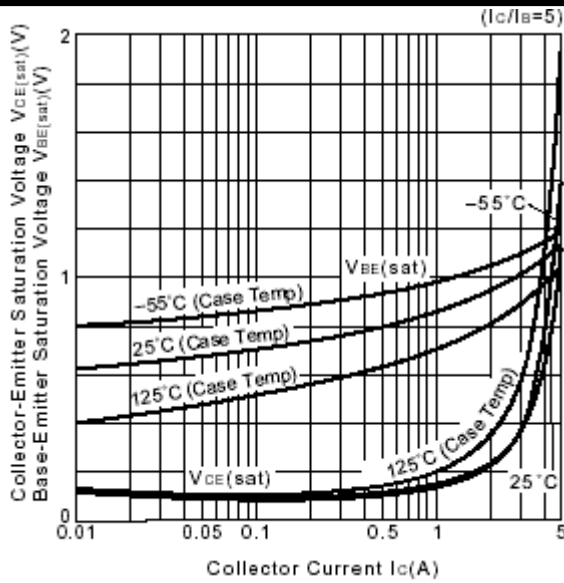

Fig.3 Base-Emmitter Saturation Voltage
Collector-Emmitter Saturation Voltage

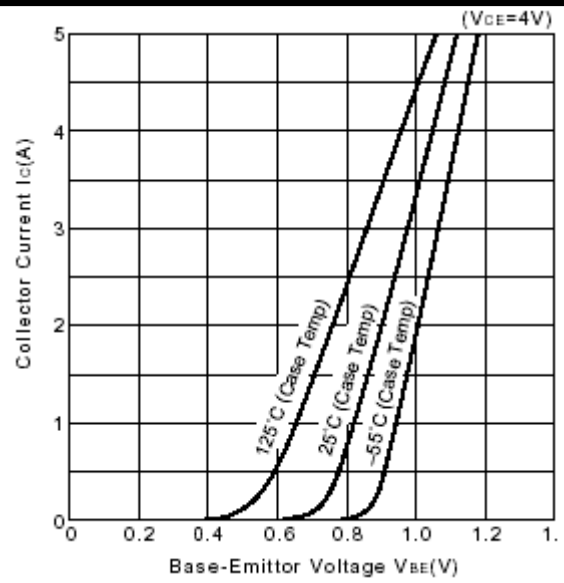

Fig.4 I_C - V_{BE}

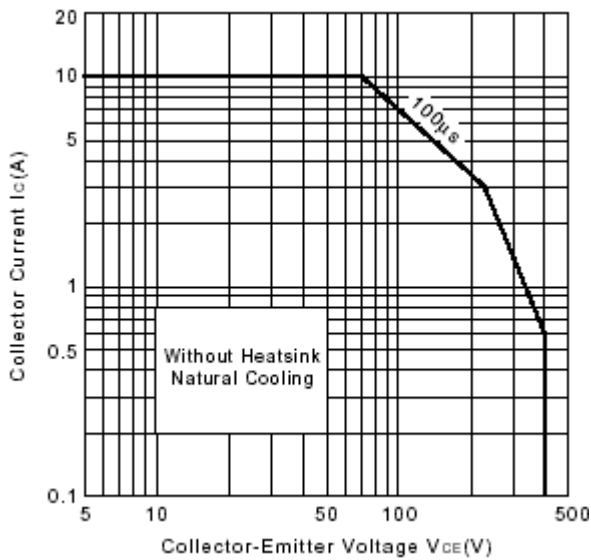

Fig.5 Safe Operating Area

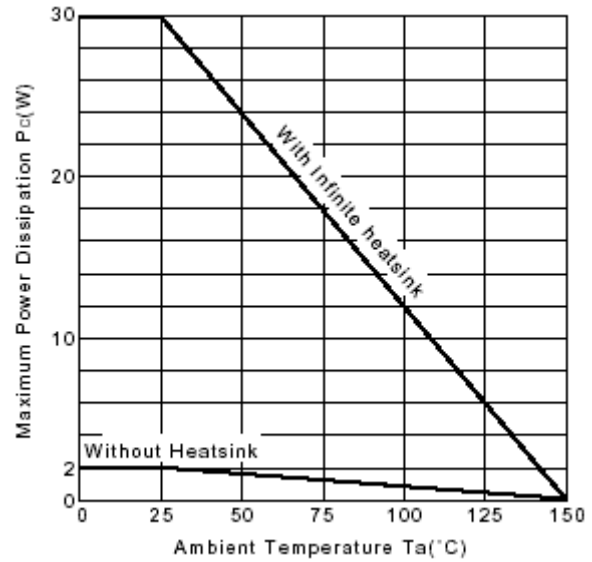

Fig.6 P_C - T_a Derating

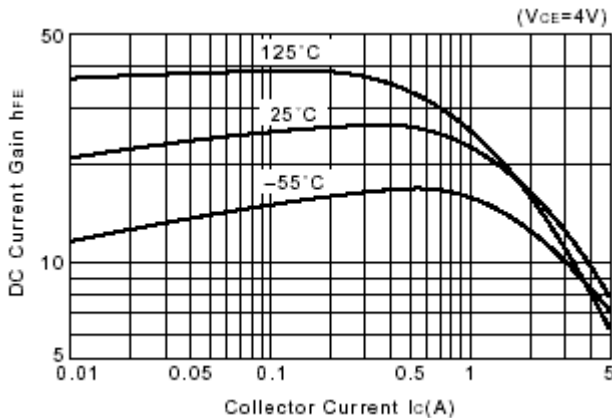

Fig.7 DC current Gain