

## FEATURES

- High Output Voltages: Up to 100V
- Large 1Ω Gate Drivers
- No Current Sense Resistor Required
- Dual N-Channel MOSFET Synchronous Drive
- ±0.5% 0.8V Voltage Reference
- Fast Transient Response
- Programmable Soft-Start
- Generates 10V Driver Supply from Input Supply
- Synchronizable to External Clock
- Power Good Output Voltage Monitor
- Adjustable Off-Time/Frequency:  $t_{OFF(MIN)} < 100ns$
- Adjustable Cycle-by-Cycle Current Limit
- Programmable Undervoltage Lockout
- Output Overvoltage Protection
- 28-Pin SSOP Package

## APPLICATIONS

- 24V Fan Supplies
- 48V Telecom and Base Station Power Supplies
- Networking Equipment, Servers
- Automotive and Industrial Control Systems

## DESCRIPTION

The LTC3813 is a synchronous step-up switching regulator controller that can generate output voltages up to 100V. The LTC3813 uses a constant off-time peak current control architecture with accurate cycle-by-cycle current limit, without requiring a sense resistor.

A precise internal reference provides ±0.5% DC accuracy. A high bandwidth (25MHz) error amplifier provides very fast line and load transient response. Large 1Ω gate drivers allow the LTC3813 to drive multiple MOSFETs for higher current applications. The operating frequency is selected by an external resistor and is compensated for variations in  $V_{IN}$  and can also be synchronized to an external clock for switching-noise sensitive applications. A shutdown pin allows the LTC3813 to be turned off, reducing the supply current to 240μA.

PARAMETER	LTC3813	LTC3814-5
Maximum $V_{OUT}$	100V	60V
MOSFET Gate Drive	6.35V to 14V	4.5V to 14V
INTV <sub>CC</sub> UV <sup>+</sup>	6.2V	4.2V
INTV <sub>CC</sub> UV <sup>-</sup>	6V	4V

LT, LT, LTC and LTM are registered trademarks of Linear Technology Corporation. All other trademarks are the property of their respective owners. Protected by U.S. Patents, including 5481178, 5847554, 6304066, 6476589, 6580258, 6677210, 6774611.

## TYPICAL APPLICATION

High Efficiency High Voltage Step-Up Converter

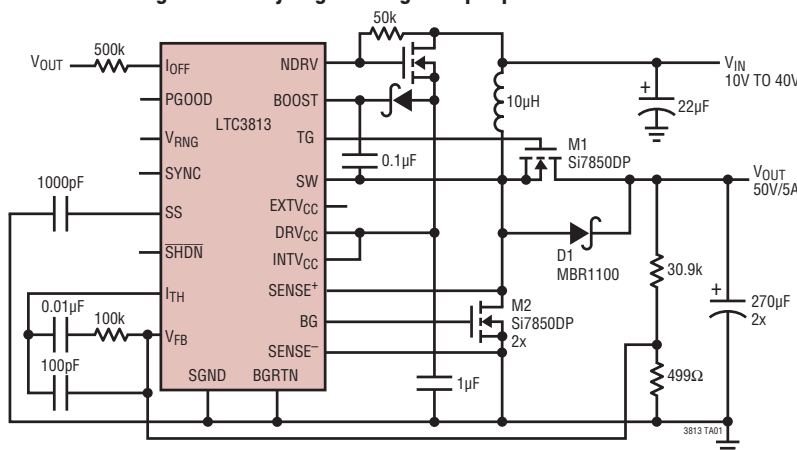

Efficiency vs Load Current

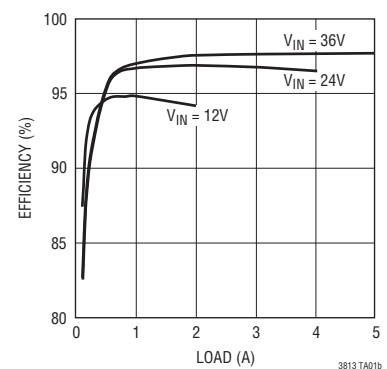

## ABSOLUTE MAXIMUM RATINGS

(Note 1)

### Supply Voltages

INTV <sub>CC</sub> , DRV <sub>CC</sub> .....	-0.3V to 14V
(DRV <sub>CC</sub> - BGRTN), (BOOST - SW).....	-0.3V to 14V
BOOST.....	-0.3V to 114V
BGRTN.....	-5V to 0V
EXTV <sub>CC</sub> .....	-0.3V to 15V
(NDRV - INTV <sub>CC</sub> ) Voltage.....	-0.3V to 10V
SW, SENSE <sup>+</sup> Voltage.....	-1V to 100V
I <sub>OFF</sub> Voltage.....	-0.3V to 100V
SS Voltage.....	-0.3V to 5V
PGOOD Voltage.....	-0.3V to 7V
V <sub>RNG</sub> , V <sub>OFF</sub> , SYNC, $\overline{\text{SHDN}}$ , UVIN Voltages.....	-0.3V to 14V
PLL/LPF, FB Voltages.....	-0.3V to 2.7V
TG, BG, INTV <sub>CC</sub> , EXTV <sub>CC</sub> RMS Currents.....	50mA
Operating Temperature Range (Note 2)	
LTC3813E.....	-40°C to 85°C
LTC3813I.....	-40°C to 125°C
Junction Temperature (Notes 3, 7).....	125°C
Storage Temperature Range.....	-65°C to 150°C
Lead Temperature (Soldering, 10 sec).....	300°C

## PIN CONFIGURATION

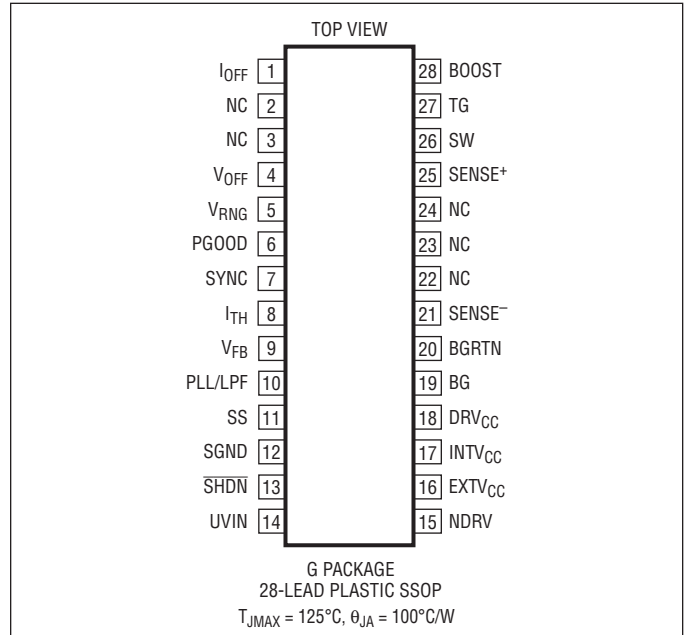

## ORDER INFORMATION

LEAD FREE FINISH	TAPE AND REEL	PART MARKING	PACKAGE DESCRIPTION	TEMPERATURE RANGE
LTC3813EG#PBF	LTC3813EG#TRPBF	LTC3813EG	28-Lead Plastic SSOP	-40°C to 85°C
LTC3813IG#PBF	LTC3813IG#TRPBF	LTC3813IG	28-Lead Plastic SSOP	-40°C to 125°C

Consult LTC Marketing for parts specified with wider operating temperature ranges.

Consult LTC Marketing for information on non-standard lead based finish parts.

For more information on lead free part marking, go to: <http://www.linear.com/leadfree/>

For more information on tape and reel specifications, go to: <http://www.linear.com/tapeandreel/>

**ELECTRICAL CHARACTERISTICS** The ● denotes specifications which apply over the full operating temperature range, otherwise specifications are at T<sub>A</sub> = 25°C, INTV<sub>CC</sub> = DRV<sub>CC</sub> = V<sub>BOOST</sub> = V<sub>OFF</sub> = V<sub>RNG</sub> =  $\overline{\text{SHDN}}$  = UV<sub>IN</sub> = V<sub>EXTVCC</sub> = V<sub>NDRV</sub> = 10V, V<sub>SYNC</sub> = V<sub>SENSE+</sub> = V<sub>SENSE-</sub> = V<sub>BGRTN</sub> = V<sub>SW</sub> = 0V, unless otherwise specified.

SYMBOL	PARAMETER	CONDITIONS	MIN	TYP	MAX	UNITS
<b>Main Control Loop</b>						
INTV <sub>CC</sub>	INTV <sub>CC</sub> Supply Voltage		● 6.35		14	V
I <sub>Q</sub>	INTV <sub>CC</sub> Supply Current	SHDN > 1.5V, INTV <sub>CC</sub> = 9.5V (Notes 4, 5) SHDN = 0V		3	6	mA
	INTV <sub>CC</sub> Shutdown Current			240	600	μA
I <sub>BOOST</sub>	BOOST Supply Current	SHDN > 1.5V (Note 5) SHDN = 0V		270	400	μA
				0	5	μA

**ELECTRICAL CHARACTERISTICS** The ● denotes specifications which apply over the full operating temperature range, otherwise specifications are at  $T_A = 25^\circ\text{C}$ ,  $\text{INTV}_{\text{CC}} = \text{DRV}_{\text{CC}} = \text{V}_{\text{BOOST}} = \text{V}_{\text{OFF}} = \text{V}_{\text{RNG}} = \text{SHDN} = \text{UV}_{\text{IN}} = \text{V}_{\text{EXTVCC}} = \text{V}_{\text{NDRV}} = 10\text{V}$ ,  $\text{V}_{\text{SYNC}} = \text{V}_{\text{SENSE}^+} = \text{V}_{\text{SENSE}^-} = \text{V}_{\text{BGRTN}} = \text{V}_{\text{SW}} = 0\text{V}$ , unless otherwise specified.

SYMBOL	PARAMETER	CONDITIONS	MIN	TYP	MAX	UNITS
$V_{\text{FB}}$	Feedback Voltage	(Note 4)	0.796	0.800	0.804	V
		$0^\circ\text{C}$ to $85^\circ\text{C}$	● 0.794	0.800	0.806	V
		$-40^\circ\text{C}$ to $85^\circ\text{C}$	● 0.792	0.800	0.806	V
		$-40^\circ\text{C}$ to $125^\circ\text{C}$ (I-Grade)	● 0.792	0.800	0.808	V
$\Delta V_{\text{FB,LIN}}$	Feedback Voltage Line Regulation	$7\text{V} < \text{INTV}_{\text{CC}} < 14\text{V}$ (Note 4)	●	0.002	0.02	%/V
$V_{\text{SENSE(MAX)}}$	Maximum Current Sense Threshold	$\text{V}_{\text{RNG}} = 2\text{V}$ , $\text{V}_{\text{FB}} = 0.76\text{V}$	256	320	384	mV
		$\text{V}_{\text{RNG}} = 0\text{V}$ , $\text{V}_{\text{FB}} = 0.76\text{V}$	70	95	120	mV
		$\text{V}_{\text{RNG}} = \text{INTV}_{\text{CC}}$ , $\text{V}_{\text{FB}} = 0.76\text{V}$	170	215	260	mV
$V_{\text{SENSE(MIN)}}$	Minimum Current Sense Threshold	$\text{V}_{\text{RNG}} = 2\text{V}$ , $\text{V}_{\text{FB}} = 0.84\text{V}$		-300		mV
		$\text{V}_{\text{RNG}} = 0\text{V}$ , $\text{V}_{\text{FB}} = 0.84\text{V}$		-85		mV
		$\text{V}_{\text{RNG}} = \text{INTV}_{\text{CC}}$ , $\text{V}_{\text{FB}} = 0.84\text{V}$		-200		mV
$I_{\text{VFB}}$	Feedback Current	$\text{V}_{\text{FB}} = 0.8\text{V}$		20	150	nA
$A_{\text{VOL(EA)}}$	Error Amplifier DC Open Loop Gain		65	100		dB
$f_{\text{U}}$	Error Amp Unity Gain Crossover Frequency	(Note 6)		25		MHz
$I_{\text{SYNC}}$	SYNC Current	SYNC = 10V		0	1	$\mu\text{A}$
$V_{\text{SHDN}}$	Shutdown Threshold		1.2	1.5	2	V
$I_{\text{SHDN}}$	SHDN Pin Input Current			0	1	$\mu\text{A}$
$I_{\text{SS}}$	SS Source Current	$\text{V}_{\text{SS}} > 0.5\text{V}$	0.7	1.4	2.5	$\mu\text{A}$
$V_{\text{VINUV}}$	$V_{\text{IN}}$ Undervoltage Lockout	$V_{\text{IN}}$ Rising	● 0.86	0.88	0.92	V
		$V_{\text{IN}}$ Falling	● 0.78	0.80	0.82	V
		Hysteresis	0.07	0.10	0.12	V
$V_{\text{VCCUV}}$	INTV <sub>CC</sub> Undervoltage Lockout	INTV <sub>CC</sub> Rising	● 6.05	6.2	6.35	V
		Hysteresis		0.5		V

#### Oscillator and Phase-Locked Loop

$t_{\text{OFF}}$	Off-Time	$I_{\text{OFF}} = 100\mu\text{A}$	1.55	1.85	2.15	$\mu\text{s}$
		$I_{\text{OFF}} = 300\mu\text{A}$	515	605	695	ns
$t_{\text{OFF(MIN)}}$	Minimum Off-Time	$I_{\text{OFF}} = 2000\mu\text{A}$			100	ns
$t_{\text{ON(MIN)}}$	Minimum On-Time			350		ns
$t_{\text{OFF(PLL)}}$	$t_{\text{OFF}}$ Modulation Range by PLL Down Modulation Up Modulation	$I_{\text{OFF}} = 100\mu\text{A}$ , $\text{V}_{\text{PLL/LPF}} = 0.6\text{V}$	2.2	3.6	5	$\mu\text{s}$
		$I_{\text{OFF}} = 100\mu\text{A}$ , $\text{V}_{\text{PLL/LPF}} = 1.8\text{V}$	0.6	1.2	1.8	$\mu\text{s}$
$I_{\text{PLL/LPF}}$	Phase Detector Output Current Sinking Capability Sourcing Capability	$f_{\text{PLLIN}} < f_{\text{SW}}$		15		$\mu\text{A}$
		$f_{\text{PLLIN}} > f_{\text{SW}}$		-25		$\mu\text{A}$

#### Driver

$I_{\text{BG,PEAK}}$	BG Driver Peak Source Current	$\text{V}_{\text{BG}} = 0\text{V}$	1.5	2		A
$R_{\text{BG,SINK}}$	BG Driver Pulldown $R_{\text{DS(ON)}}$			1	1.5	$\Omega$
$I_{\text{TG,PEAK}}$	TG Driver Peak Source Current	$\text{V}_{\text{TG}} - \text{V}_{\text{SW}} = 0\text{V}$	1.5	2		A
$R_{\text{TG,SINK}}$	TG Driver Pulldown $R_{\text{DS(ON)}}$			1	1.5	$\Omega$

#### PGOOD Output

$\Delta V_{\text{FBOV}}$	PGOOD Upper Threshold PGOOD Lower Threshold	$\text{V}_{\text{FB}}$ Rising	7.5	10	12.5	%
		$\text{V}_{\text{FB}}$ Falling	-7.5	-10	-12.5	%
$\Delta V_{\text{FB,HYST}}$	PGOOD Hysteresis	$\text{V}_{\text{FB}}$ Returning		1.5	3	%
$V_{\text{PGOOD}}$	PGOOD Low Voltage	$I_{\text{PGOOD}} = 5\text{mA}$		0.3	0.6	V

**ELECTRICAL CHARACTERISTICS** The ● denotes specifications which apply over the full operating temperature range, otherwise specifications are at  $T_A = 25^\circ\text{C}$ ,  $\text{INTV}_{\text{CC}} = \text{DRV}_{\text{CC}} = \text{V}_{\text{BOOST}} = \text{V}_{\text{OFF}} = \text{V}_{\text{RNG}} = \text{SHDN} = \text{UV}_{\text{IN}} = \text{V}_{\text{EXTV}_{\text{CC}}} = \text{V}_{\text{NDRV}} = 10\text{V}$ ,  $\text{V}_{\text{SYNC}} = \text{V}_{\text{SENSE}^+} = \text{V}_{\text{SENSE}^-} = \text{V}_{\text{BGRTN}} = \text{V}_{\text{SW}} = 0\text{V}$ , unless otherwise specified.

SYMBOL	PARAMETER	CONDITIONS	MIN	TYP	MAX	UNITS
$I_{\text{PGOOD}}$	PGOOD Leakage Current	$V_{\text{PGOOD}} = 5\text{V}$		0	2	$\mu\text{A}$
PG Delay	PGOOD Delay	$V_{\text{FB}}$ Falling		125		$\mu\text{s}$

#### V<sub>CC</sub> Regulators

$V_{\text{EXTV}_{\text{CC}}}$	EXTV <sub>CC</sub> Switchover Voltage EXTV <sub>CC</sub> Rising EXTV <sub>CC</sub> Hysteresis		●	6.4 0.1	6.7 0.25	0.5	V V
$V_{\text{INTV}_{\text{CC},1}}$	INTV <sub>CC</sub> Voltage from EXTV <sub>CC</sub>	$10.5\text{V} < V_{\text{EXTV}_{\text{CC}}} < 15\text{V}$		9.4	10	10.6	V
$\Delta V_{\text{EXTV}_{\text{CC},1}}$	$V_{\text{EXTV}_{\text{CC}}} - V_{\text{INTV}_{\text{CC}}}$ at Dropout	$I_{\text{CC}} = 20\text{mA}$ , $V_{\text{EXTV}_{\text{CC}}} = 9.1\text{V}$			170	250	mV
$\Delta V_{\text{LOADREG},1}$	INTV <sub>CC</sub> Load Regulation from EXTV <sub>CC</sub>	$I_{\text{CC}} = 0\text{mA}$ to $20\text{mA}$ , $V_{\text{EXTV}_{\text{CC}}} = 12\text{V}$			0.01		%
$V_{\text{INTV}_{\text{CC},2}}$	INTV <sub>CC</sub> Voltage from NDRV Regulator	Linear Regulator in Operation		9.4	10	10.6	V
$\Delta V_{\text{LOADREG},2}$	INTV <sub>CC</sub> Load Regulation from NDRV	$I_{\text{CC}} = 0\text{mA}$ to $20\text{mA}$ , $V_{\text{EXTV}_{\text{CC}}} = 0$			0.01		%
$I_{\text{NDRV}}$	Current into NDRV Pin	$V_{\text{NDRV}} - V_{\text{INTV}_{\text{CC}}} = 3\text{V}$		20	40	60	$\mu\text{A}$
$V_{\text{CCSR}}$	Maximum Supply Voltage	Trickle Charger Shunt Regulator			15		V
$I_{\text{CCSR}}$	Maximum Current into NDRV/INTV <sub>CC</sub>	Trickle Charger Shunt Regulator, $\text{INTV}_{\text{CC}} \leq 16.7\text{V}$ (Note 8)		10			mA

**Note 1:** Stresses beyond those listed under Absolute Maximum Ratings may cause permanent damage to the device. Exposure to any Absolute Maximum Rating condition for extended periods may affect device reliability and lifetime.

**Note 2:** The LTC3813E is guaranteed to meet performance specifications from  $0^\circ\text{C}$  to  $85^\circ\text{C}$ . Specifications over the  $-40^\circ\text{C}$  to  $85^\circ\text{C}$  operating temperature range are assured by design, characterization and correlation with statistical process controls. The LTC3813I is guaranteed to meet performance specifications over the full  $-40^\circ\text{C}$  to  $125^\circ\text{C}$  operating temperature range.

**Note 3:**  $T_J$  is calculated from the ambient temperature  $T_A$  and power dissipation  $P_D$  according to the following formula:

$$\text{LTC3813: } T_J = T_A + (P_D \cdot 100^\circ\text{C/W})$$

**Note 4:** The LTC3813 is tested in a feedback loop that servos  $V_{\text{FB}}$  to the reference voltage with the  $I_{\text{TH}}$  pin forced to a voltage between 1V and 2V.

**Note 5:** The dynamic input supply current is higher due to the power MOSFET gate charging being delivered at the switching frequency ( $Q_G \cdot f_{\text{SW}}$ ).

**Note 6:** Guaranteed by design. Not subject to test.

**Note 7:** This IC includes overtemperature protection that is intended to protect the device during momentary overload conditions. Junction temperature will exceed  $125^\circ\text{C}$  when overtemperature protection is active. Continuous operation above the specified maximum operating junction temperature may impair device reliability.

**Note 8:**  $I_{\text{CC}}$  is the sum of current into NDRV and INTV<sub>CC</sub>.

# TYPICAL PERFORMANCE CHARACTERISTICS

**Load Transient Response**

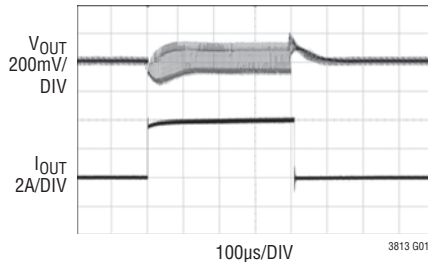
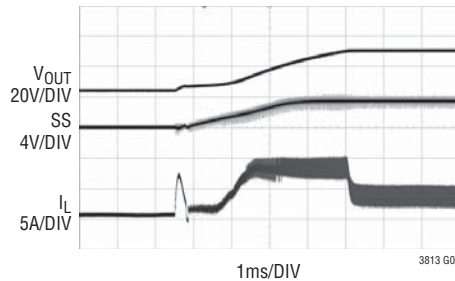

FIGURE 14 CIRCUIT  
 $V_{IN} = 12V$   
 0A TO 4A LOAD STEP

**Start-Up**



FRONT PAGE CIRCUIT  
 $V_{IN} = 24V$   
 $I_{LOAD} = 2A$

**Overcurrent Operation**

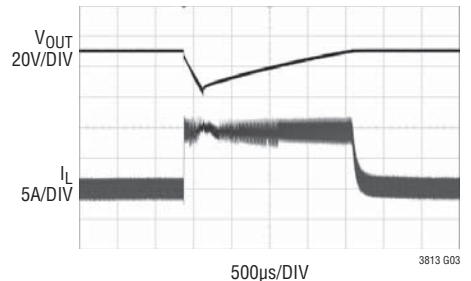

FRONT PAGE CIRCUIT  
 $V_{IN} = 24V$   
 $R_{SHORT} = 1\Omega$

**Efficiency vs Load Current**

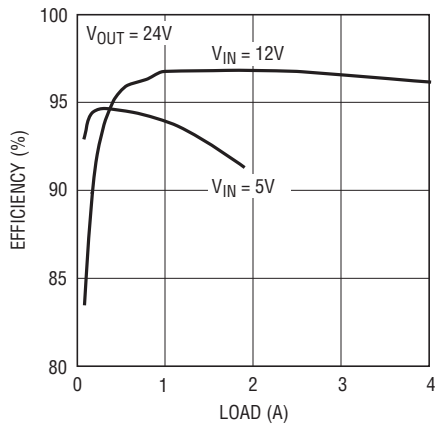

3813 G04

**Frequency vs Input Voltage**

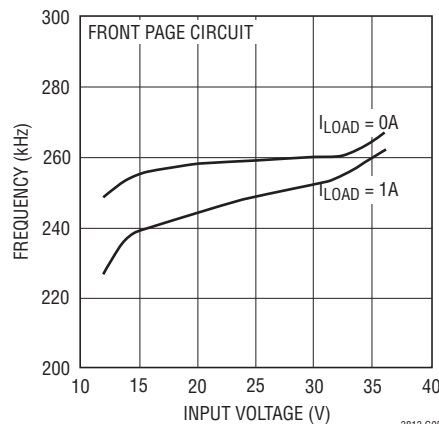

3813 G05

**Frequency vs Load Current**

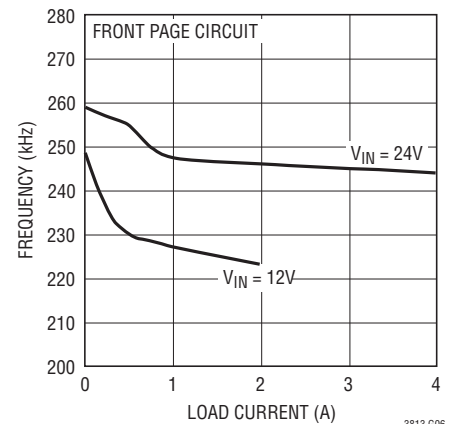

3813 G06

**Current Sense Threshold vs  $I_{TH}$  Voltage**

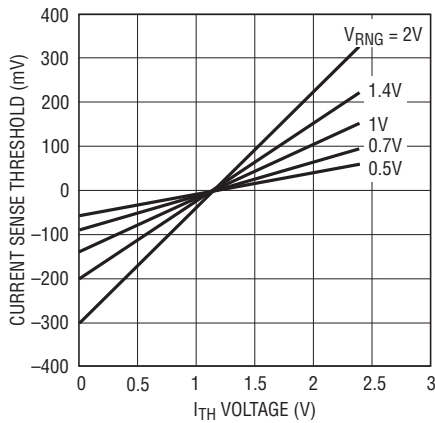

3813 G07

**Off-Time vs  $I_{OFF}$  Current**

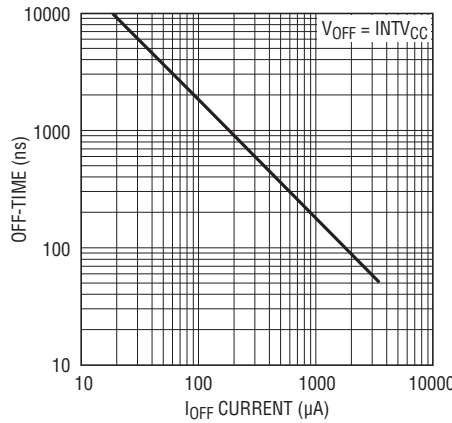

3813 G08

**Off-Time vs  $V_{OFF}$  Voltage**

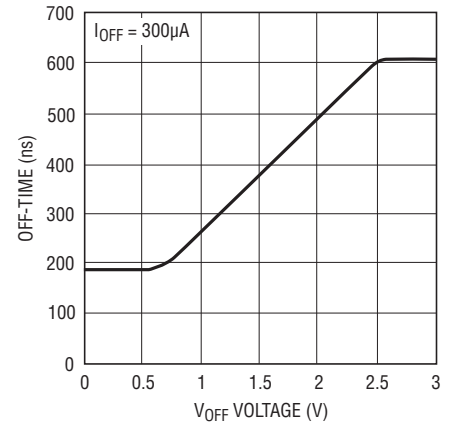

3813 G09

## TYPICAL PERFORMANCE CHARACTERISTICS

**Off-Time vs Temperature**

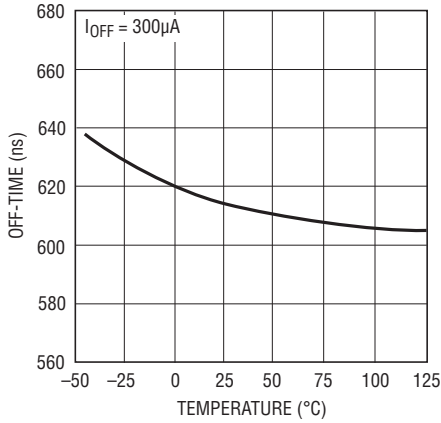

3813 G10

**Maximum Current Sense Threshold vs  $V_{RNG}$  Voltage**

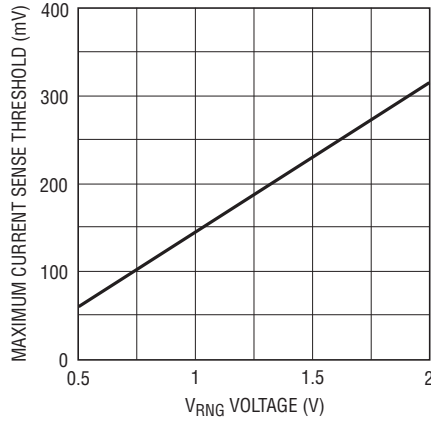

3813 G11

**Maximum Current Sense Threshold vs Temperature**

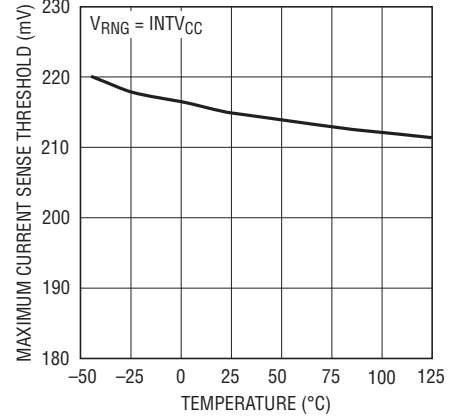

3813 G12

**Feedback Reference Voltage vs Temperature**

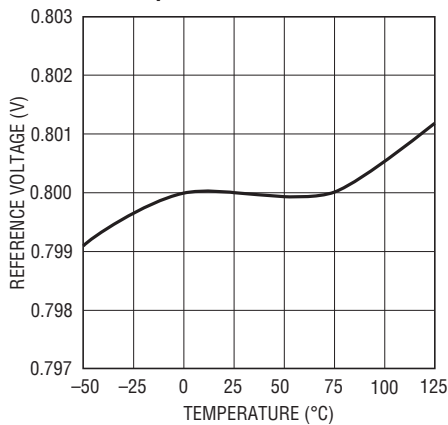

3813 G13

**Driver Peak Source Current vs Temperature**

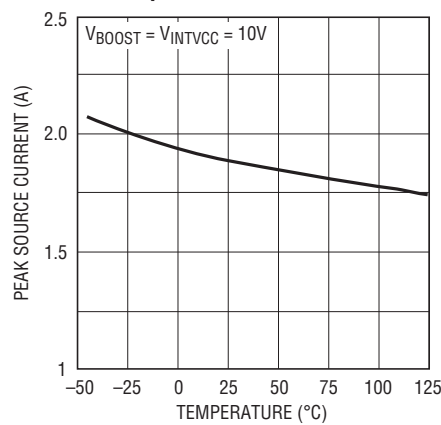

3813 G14

**Driver Pulldown  $R_{DS(ON)}$  vs Temperature**

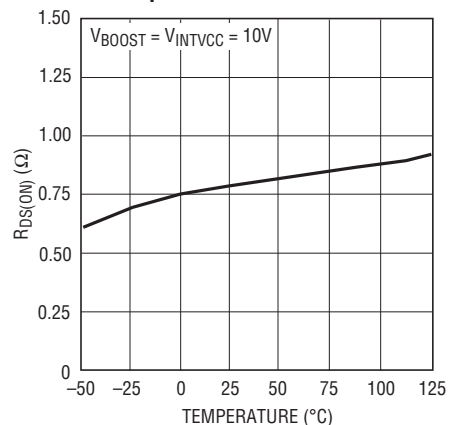

3813 G15

**Driver Peak Source Current vs Supply Voltage**

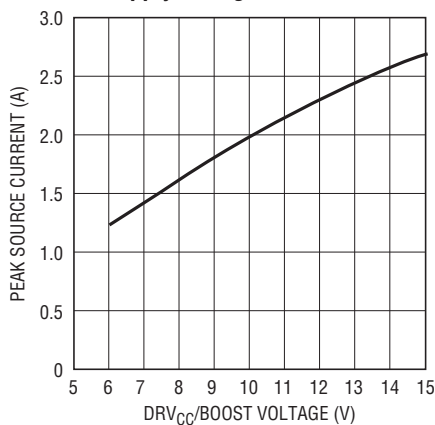

3813 G16

**Driver Pulldown  $R_{DS(ON)}$  vs Supply Voltage**

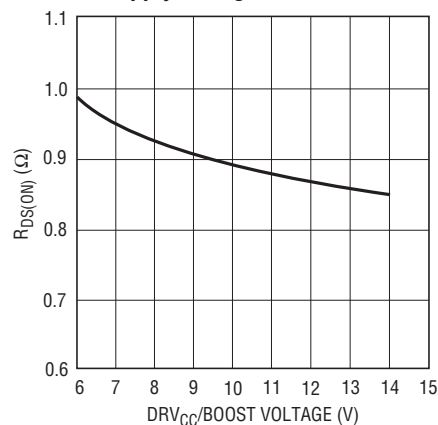

3813 G17

# TYPICAL PERFORMANCE CHARACTERISTICS

**EXTV<sub>CC</sub> LDO Resistance at Dropout vs Temperature**

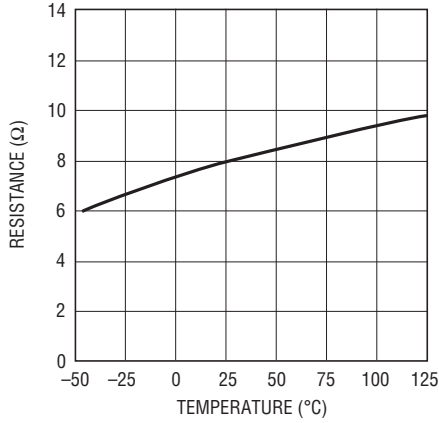

3813 G18

**INTV<sub>CC</sub> Current vs Temperature**

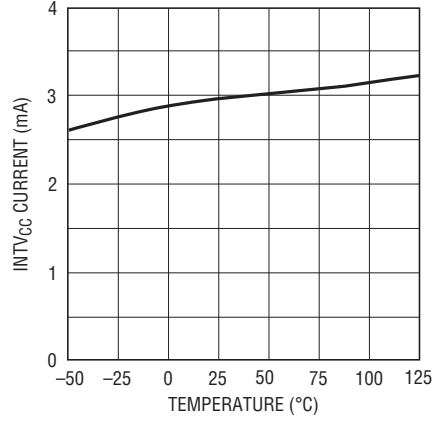

3813 G19

**INTV<sub>CC</sub> Shutdown Current vs Temperature**

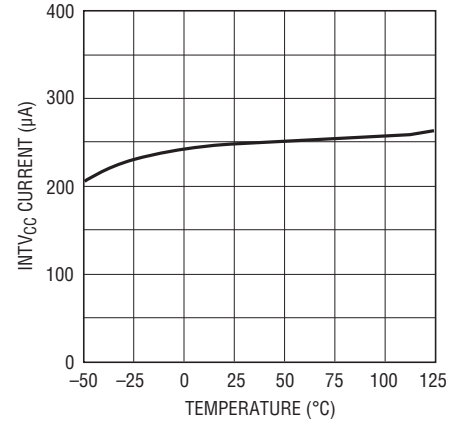

3813 G20

**INTV<sub>CC</sub> Current vs INTV<sub>CC</sub> Voltage**

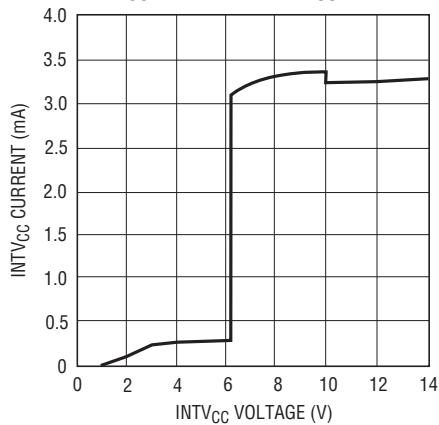

3813 G21

**INTV<sub>CC</sub> Shutdown Current vs INTV<sub>CC</sub> Voltage**

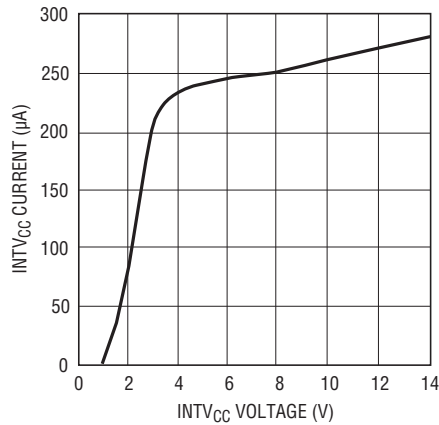

3813 G22

**SS Pull-Up Current vs Temperature**

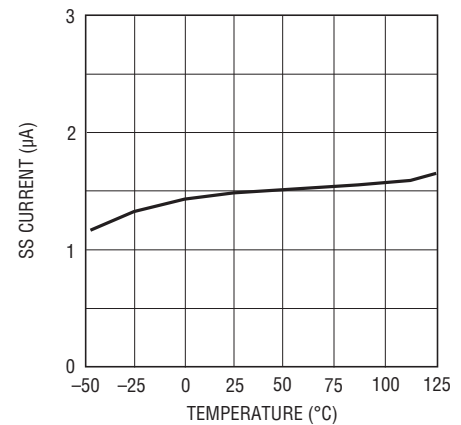

3813 G23

**I<sub>TH</sub> Voltage vs Load Current**

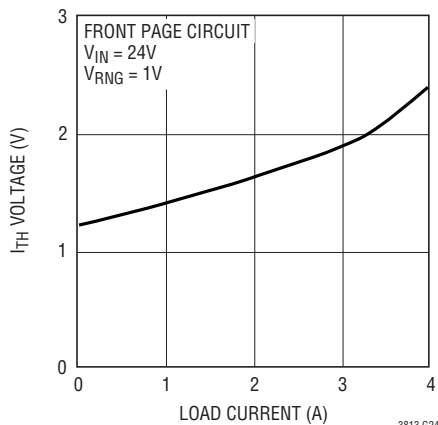

3813 G24

**Shutdown Threshold vs Temperature**

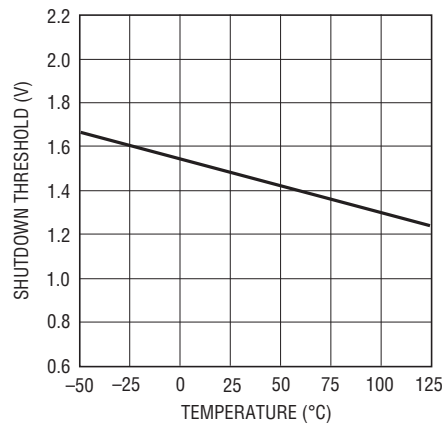

3813 G25

## PIN FUNCTIONS

**I<sub>OFF</sub> (Pin 1):** Off-Time Current Input. Tie a resistor from  $V_{OUT}$  to this pin to set the one-shot timer current and thereby set the switching frequency.

**V<sub>OFF</sub> (Pin 4):** Off-Time Voltage Input. Voltage trip point for the on-time comparator. Tying this pin to an external resistive divider from the input makes the off-time proportional to  $V_{IN}$ . The comparator defaults to 0.7V when the pin is grounded and defaults to 2.4V when the pin is connected to  $INTV_{CC}$ .

**V<sub>RNG</sub> (Pin 5):** Sense Voltage Limit Set. The voltage at this pin sets the nominal sense voltage at maximum output current and can be set from 0.5V to 2V by a resistive divider from  $INTV_{CC}$ . The nominal sense voltage defaults to 95mV when this pin is tied to ground, and 215mV when tied to  $INTV_{CC}$ .

**PGOOD (Pin 6):** Power Good Output. Open-drain logic output that is pulled to ground when the output voltage is not between  $\pm 10\%$  of the regulation point. The output voltage must be out of regulation for at least 125 $\mu$ s before the power good output is pulled to ground.

**SYNC (Pin 7):** Sync Pin. This pin provides an external clock input to the phase detector. The phase-locked loop will force the rising top gate signal to be synchronized with the rising edge of the clock signal.

**I<sub>TH</sub> (Pin 8):** Error Amplifier Compensation Point and Current Control Threshold. The current comparator threshold increases with control voltage. The voltage ranges from 0V to 2.6V with 1.2V corresponding to zero sense voltage (zero current).

**V<sub>FB</sub> (Pin 9):** Feedback Input. Connect  $V_{FB}$  through a resistor divider network to  $V_{OUT}$  to set the output voltage.

**PLL/LPF (Pin 10):** The phase-locked loop's lowpass filter is tied to this pin. The voltage at this pin defaults to 1.2V when the IC is not synchronized with an external clock at the SYNC pin.

**SS (Pin 11):** Soft-Start Input. A capacitor to ground at this pin sets the ramp rate of the maximum current sense threshold.

**SGND (Pin 12):** Signal Ground. All small signal components should connect to this ground and eventually connect to PGND at one point.

**SHDN (Pin 13):** Shutdown Pin. Pulling this pin below 1.5V will shut down the LTC3813, turn off both of the external MOSFET switches and reduce the quiescent supply current to 240 $\mu$ A.

**UVIN (Pin 14):** UVLO Input. This pin is input to the internal UVLO and is compared to an internal 0.8V reference. An external resistor divider is connected to this pin and the input supply to program the undervoltage lockout voltage. When UVIN is less than 0.8V, the LTC3813 is shut down.

**NDRV (Pin 15):** Drive Output for External Pass Device of the Linear Regulator for  $INTV_{CC}$ . Connect to the gate of an external NMOS pass device and a pull-up resistor to the input voltage  $V_{IN}$  or the output voltage  $V_{OUT}$ .

**EXTV<sub>CC</sub> (Pin 16):** External Driver Supply Voltage. When this voltage exceeds 6.7V, an internal switch connects this pin to  $INTV_{CC}$  through an LDO and turns off the external MOSFET connected to NDRV, so that controller and gate drive are drawn from  $EXTV_{CC}$ .

**INTV<sub>CC</sub> (Pin 17):** Main Supply Pin. All internal circuits except the output drivers are powered from this pin.  $INTV_{CC}$  should be bypassed to ground (Pin 10) with at least a 0.1 $\mu$ F capacitor in close proximity to the LTC3813.

**DRV<sub>CC</sub> (Pin 18):** Driver Supply Pin.  $DRV_{CC}$  supplies power to the BG output driver. This pin is normally connected to  $INTV_{CC}$ .  $DRV_{CC}$  should be bypassed to BGRTN (Pin 20) with a low ESR (X5R or better) 1 $\mu$ F capacitor in close proximity to the LTC3813.



## PIN FUNCTIONS

**BG (Pin 19):** Bottom Gate Drive. The BG pin drives the gate of the bottom N-channel main switch MOSFET. This pin swings from BGRTN to  $DRV_{CC}$ .

**BGRTN (Pin 20):** Bottom Gate Return. This pin connects to the source of the pulldown MOSFET in the BG driver and is normally connected to ground. Connecting a negative supply to this pin allows the main MOSFET's gate to be pulled below ground to help prevent false turn-on during high  $dV/dt$  transitions on the SW node. See the Applications Information section for more details.

**SENSE<sup>+</sup>, SENSE<sup>-</sup> (Pin 25, Pin 21):** Current Sense Comparator Input. The (+) input to the current comparator is normally connected to SW unless using a sense resistor. The (-) input is used to accurately kelvin sense the bottom side of the sense resistor or MOSFET.

**SW (Pin 26):** Switch Node Connection to Inductor and Bootstrap Capacitor. Voltage swing at this pin is from a Schottky diode (external) voltage drop below ground to  $V_{OUT}$ .

**TG (Pin 27):** Top Gate Drive. The TG pin drives the gate of the top N-channel synchronous switch MOSFET. The TG driver draws power from the BOOST pin and returns to the SW pin, providing true floating drive to the top MOSFET.

**BOOST (Pin 28):** Top Gate Driver Supply. The BOOST pin supplies power to the floating TG driver. BOOST should be bypassed to SW with a low ESR (X5R or better) 0.1 $\mu$ F capacitor. An additional fast recovery Schottky diode from  $DRV_{CC}$  to the BOOST pin will create a complete floating charge-pumped supply at BOOST.

FUNCTIONAL DIAGRAM

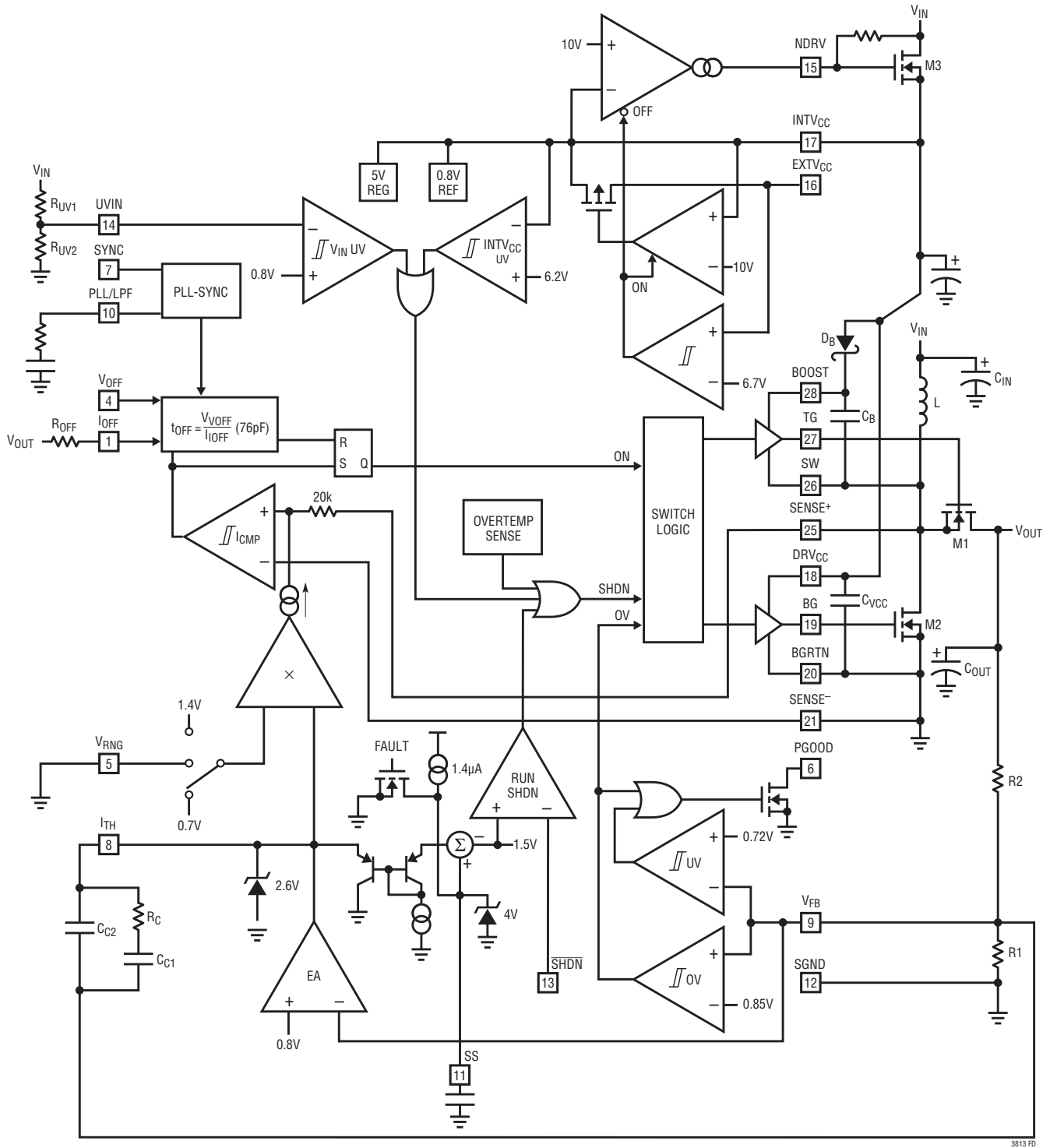

3813 FD

## OPERATION

### Main Control Loop

The LTC3813 is a current mode controller for DC/DC step-up converters. In normal operation, the top MOSFET is turned on for a fixed interval determined by a one-shot timer (OST). When the top MOSFET is turned off, the bottom MOSFET is turned on until the current comparator  $I_{CMP}$  trips, restarting the one-shot timer and initiating the next cycle. Inductor current is determined by sensing the voltage between the  $SENSE^-$  and  $SENSE^+$  pins using a sense resistor or the bottom MOSFET on-resistance. The voltage on the  $I_{TH}$  pin sets the comparator threshold corresponding to the inductor peak current. The fast 25MHz error amplifier EA adjusts this voltage by comparing the feedback signal  $V_{FB}$  to the internal 0.8V reference voltage. If the load current increases, it causes a drop in the feedback voltage relative to the reference. The  $I_{TH}$  voltage then rises until the average inductor current again matches the load current.

The operating frequency is determined implicitly by the top MOSFET on-time ( $t_{OFF}$ ) and the duty cycle required to maintain regulation. The one-shot timer generates a top MOSFET on-time that is inversely proportional to the  $I_{OFF}$  current and proportional to the  $V_{OFF}$  voltage. Connecting  $V_{OUT}$  to  $I_{OFF}$  and  $V_{IN}$  to  $V_{OFF}$  with a resistive divider keeps the frequency approximately constant with changes in  $V_{IN}$ . The nominal frequency can be adjusted with an external resistor  $R_{OFF}$ .

For applications with stringent constant-frequency requirements, the LTC3813 can be synchronized with an external clock. By programming the nominal frequency the same as the external clock frequency, the LTC3813 behaves as a constant-frequency part against the load and supply variations.

Pulling the  $\overline{SHDN}$  pin low forces the controller into its shutdown state, turning off both M1 and M2. Forcing a voltage above 1.5V will turn on the device.

### Fault Monitoring/Protection

Constant off-time current mode architecture provides accurate cycle-by-cycle current limit protection—a feature that is very important for protecting the high voltage power supply from output overcurrent conditions. The cycle-by-cycle current monitor guarantees that the

inductor current will never exceed the value programmed on the  $V_{RNG}$  pin.

Overvoltage and undervoltage comparators OV and UV pull the PGOOD output low if the output feedback voltage exits a  $\pm 10\%$  window around the regulation point after the internal 125 $\mu$ s power bad mask timer expires. Furthermore, in an overvoltage condition, M1 is turned off and M2 is turned on immediately and held on until the overvoltage condition clears.

The LTC3813 provides two undervoltage lockout comparators—one for the  $INTV_{CC}/DRV_{CC}$  supply and one for the input supply  $V_{IN}$ . The  $INTV_{CC}$  UV threshold is 6.2V to guarantee that the MOSFETs have sufficient gate drive voltage before turning on. The  $V_{IN}$  UV threshold (UVIN pin) is 0.8V with 10% hysteresis which allows programming the  $V_{IN}$  threshold with the appropriate resistor divider connected to  $V_{IN}$ . If either comparator inputs are under the UV threshold, the LTC3813 is shut down and the drivers are turned off.

### Strong Gate Drivers

The LTC3813 contains very low impedance drivers capable of supplying amps of current to slew large MOSFET gates quickly. This minimizes transition losses and allows paralleling MOSFETs for higher current applications. A 100V floating high side driver drives the top side MOSFET and a low side driver drives the bottom side MOSFET (see Figure 1). The bottom side driver is supplied directly from the  $DRV_{CC}$  pin. The top MOSFET drivers are biased from floating bootstrap capacitor  $C_B$ , which normally is recharged during each off cycle through an external diode

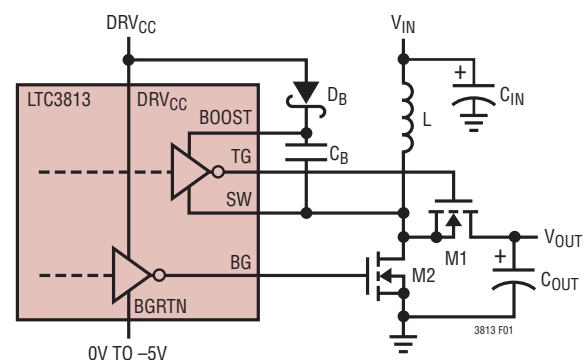

Figure 1. Floating TG Driver Supply and Negative BG Return

## OPERATION

from  $DRV_{CC}$  when the top MOSFET turns off. In an output overvoltage condition, where it is possible that the bottom MOSFET will be off for an extended period of time, an internal timeout guarantees that the bottom MOSFET is turned on at least once every 25 $\mu$ s for one top MOSFET on-time period to refresh the bootstrap capacitor.

The bottom driver has an additional feature that helps minimize the possibility of external MOSFET shoot-thru. When the top MOSFET turns on, the switch node  $dV/dt$  pulls up the bottom MOSFET's internal gate through the Miller capacitance, even when the bottom driver is holding the gate terminal at ground. If the gate is pulled up high enough, shoot-thru between the top side and bottom side MOSFETs can occur. To prevent this from occurring, the bottom driver return is brought out as a separate pin (BGRTN) so that a negative supply can be used to reduce the effect of the Miller pull-up. For example, if a  $-2V$

supply is used on BGRTN, the switch node  $dV/dt$  could pull the gate up 2V before the  $V_{GS}$  of the bottom MOSFET has more than 0V across it.

### IC/Driver Supply Power and Linear Regulators

The LTC3813's internal control circuitry and top and bottom MOSFET drivers operate from a supply voltage ( $INTV_{CC}$ ,  $DRV_{CC}$  pins) in the range of 6.2V to 14V. If the input supply voltage or another available supply is within this voltage range it can be used to supply IC/driver power. If a supply in this range is not available, two internal regulators are available to generate a 10V supply from the input or output. An internal low dropout regulator is good for voltages up to 15V, and the second, a linear regulator controller, controls the gate of an external NMOS to generate the 10V supply. Since the NMOS is external, the user has the flexibility to choose a  $BV_{DSS}$  as high as necessary.

## APPLICATIONS INFORMATION

The basic LTC3813 application circuit is shown on the first page of this data sheet. External component selection is primarily determined by the maximum input voltage and load current and begins with the selection of the sense resistance and power MOSFET switches. The LTC3813 uses either a sense resistor or the on-resistance of the synchronous power MOSFET for determining the inductor current. The desired amount of ripple current and operating frequency largely determines the inductor value. Next,  $C_{OUT}$  is selected for its ability to handle the large RMS current and with low enough ESR to meet the output voltage ripple and transient specification. Finally, loop compensation components are selected to meet the required transient/phase margin specifications.

### Duty Cycle Considerations

For a boost converter, the duty cycle of the main switch is:

$$D = 1 - \frac{V_{IN}}{V_{OUT}}; D_{MAX} = 1 - \frac{V_{IN(MIN)}}{V_{OUT}}$$

The maximum  $V_{OUT}$  capability of the LTC3813 is inversely proportional to the minimum desired operating frequency and minimum off-time:

$$V_{OUT(MAX)} = \frac{V_{IN(MIN)}}{f_{MIN} \cdot t_{OFF(MIN)}} \leq 100V$$

### Maximum Sense Voltage and the $V_{RNG}$ Pin

The control circuit in the LTC3813 measures the input current by using the  $R_{DS(ON)}$  of the bottom MOSFET or by using a sense resistor in the bottom MOSFET source, so the output current needs to be reflected back to the input in order to dimension the power MOSFET properly and to choose the maximum sense voltage. Based on the fact that, ideally, the output power is equal to the input power, the maximum average input current and average inductor current is:

$$I_{IN(MAX)} = I_{L,AVG(MAX)} = \frac{I_{O(MAX)}}{1 - D_{MAX}}$$

The current mode control loop will not allow the inductor peak to exceed  $V_{SENSE(MAX)}/R_{SENSE}$ . In practice, one should allow some margin for variations in the LTC3813 and external component values, and a good guide for selecting the maximum sense voltage when  $V_{DS}$  sensing is used is:

$$V_{SENSE(MAX)} = \frac{1.7 \cdot R_{DS(ON)} \cdot I_{O(MAX)}}{1 - D_{MAX}}$$

$V_{SENSE}$  is set by the voltage applied to the  $V_{RNG}$  pin. Once  $V_{SENSE}$  is chosen, the required  $V_{RNG}$  voltage is calculated to be:

$$V_{RNG} = 5.78 \cdot (V_{SENSE(MAX)} + 0.026)$$

An external resistive divider from  $INTV_{CC}$  can be used to set the voltage of the  $V_{RNG}$  pin between 0.5V and 2V resulting in nominal sense voltages of 60mV to 320mV. Additionally, the  $V_{RNG}$  pin can be tied to  $SGND$  or  $INTV_{CC}$  in which case the nominal sense voltage defaults to 95mV or 215mV, respectively.

### Connecting the $SENSE^+$ and $SENSE^-$ Pins

The LTC3813 can be used with or without a sense resistor. When using a sense resistor, place it between the source of the bottom MOSFET, M2, and  $PGND$ . Connect the  $SENSE^+$  and  $SENSE^-$  pins to the top and bottom of the sense resistor. Using a sense resistor provides a well defined current limit, but adds cost and reduces efficiency. Alternatively, one can eliminate the sense resistor and use the bottom MOSFET as the current sense element by simply connecting the  $SENSE^+$  pin to the lower MOSFET drain and  $SENSE^-$  pin to the MOSFET source. This improves efficiency, but one must carefully choose the MOSFET on-resistance, as discussed in the following section.

## APPLICATIONS INFORMATION

### Power MOSFET Selection

The LTC3813 requires two external N-channel power MOSFETs, one for the bottom (main) switch and one for the top (synchronous) switch. Important parameters for the power MOSFETs are the breakdown voltage  $BV_{DSS}$ , threshold voltage  $V_{(GS)TH}$ , on-resistance  $R_{DS(ON)}$ , Miller capacitance and maximum current  $I_{DS(MAX)}$ .

When the bottom MOSFET is used as the current sense element, particular attention must be paid to its on-resistance. MOSFET on-resistance is typically specified with a maximum value  $R_{DS(ON)(MAX)}$  at 25°C. In this case, additional margin is required to accommodate the rise in MOSFET on-resistance with temperature:

$$R_{DS(ON)(MAX)} = \frac{R_{SENSE}}{\rho_T}$$

The  $\rho_T$  term is a normalization factor (unity at 25°C) accounting for the significant variation in on-resistance with temperature (see Figure 2) and typically varies from 0.4%/°C to 1.0%/°C depending on the particular MOSFET used.

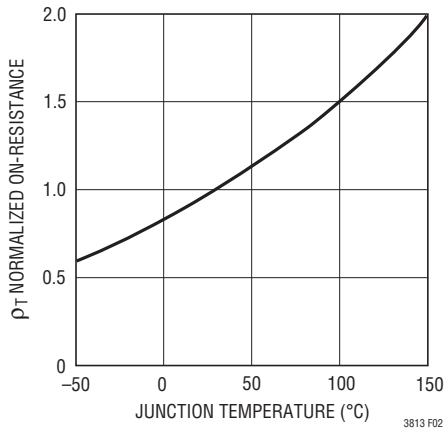

Figure 2.  $R_{DS(ON)}$  vs Temperature

The most important parameter in high voltage applications is breakdown voltage  $BV_{DSS}$ . Both the top and bottom MOSFETs will see full output voltage plus any additional ringing on the switch node across its drain-to-source during its off-time and must be chosen with the appropriate breakdown specification. Since most MOSFETs in the 60V to 100V range have higher thresholds (typically  $V_{GS(MIN)} \geq 6V$ ), the LTC3813 is designed to be used with a 6.2V to 14V gate drive supply (DRV<sub>CC</sub> pin).

For maximum efficiency, on-resistance  $R_{DS(ON)}$  and input capacitance should be minimized. Low  $R_{DS(ON)}$  minimizes conduction losses and low input capacitance minimizes transition losses. MOSFET input capacitance is a combination of several components but can be taken from the typical “gate charge” curve included on most data sheets (Figure 3).

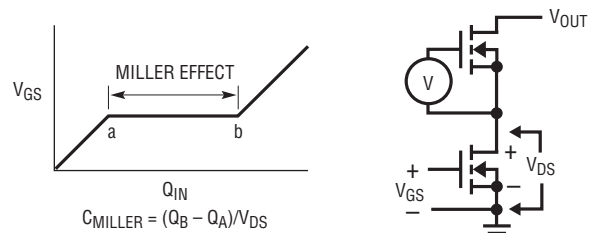

Figure 3. Gate Charge Characteristic

The curve is generated by forcing a constant input current into the gate of a common source, current source loaded stage and then plotting the gate voltage versus time. The initial slope is the effect of the gate-to-source and the gate-to-drain capacitance. The flat portion of the curve is the result of the Miller multiplication effect of the drain-to-gate capacitance as the drain drops the voltage across the current source load. The upper sloping line is due to the drain-to-gate accumulation capacitance and the gate-to-source capacitance. The Miller charge (the

## APPLICATIONS INFORMATION

increase in coulombs on the horizontal axis from a to b while the curve is flat) is specified for a given  $V_{DS}$  drain voltage, but can be adjusted for different  $V_{DS}$  voltages by multiplying by the ratio of the application  $V_{DS}$  to the curve specified  $V_{DS}$  values. A way to estimate the  $C_{MILLER}$  term is to take the change in gate charge from points a and b on a manufacturer's data sheet and divide by the stated  $V_{DS}$  voltage specified.  $C_{MILLER}$  is the most important selection criteria for determining the transition loss term in the top MOSFET but is not directly specified on MOSFET data sheets.  $C_{RSS}$  and  $C_{OS}$  are specified sometimes but definitions of these parameters are not included.

When the controller is operating in continuous mode the duty cycles for the top and bottom MOSFETs are given by:

$$\text{Main Switch Duty Cycle} = \frac{V_{OUT} - V_{IN}}{V_{OUT}}$$

$$\text{Synchronous Switch Duty Cycle} = \frac{V_{IN}}{V_{OUT}}$$

The power dissipation for the main and synchronous MOSFETs at maximum output current are given by:

$$P_{MAIN} = D_{MAX} \left( \frac{I_{O(MAX)}}{1 - D_{MAX}} \right)^2 (\rho_T) R_{DS(ON)} + \frac{1}{2} V_{OUT}^2 \left( \frac{I_{O(MAX)}}{1 - D_{MAX}} \right) (R_{DR}) (C_{MILLER}) \cdot \left[ \frac{1}{DRV_{CC} - V_{TH(IL)}} + \frac{1}{V_{TH(IL)}} \right] (f)$$

$$P_{SYNC} = \left( \frac{1}{1 - D_{MAX}} \right) (I_{O(MAX)})^2 (\rho_T) R_{DS(ON)}$$

where  $\rho_T$  is the temperature dependency of  $R_{DS(ON)}$ ,  $R_{DR}$  is the effective top driver resistance (approximately  $2\Omega$  at  $V_{GS} = V_{MILLER}$ ).  $V_{TH(IL)}$  is the data sheet specified typical gate threshold voltage specified in the power MOSFET data sheet at the specified drain current.  $C_{MILLER}$  is the calculated capacitance using the gate charge curve from the MOSFET data sheet and the technique described above.

Both MOSFETs have  $I^2R$  losses while the bottom N-channel equation includes an additional term for transition losses. Both top and bottom MOSFET  $I^2R$  losses are greatest at lowest  $V_{IN}$ , and the top MOSFET  $I^2R$  losses also peak during an overcurrent condition when it is on close to 100% of the period. For most LTC3813 applications, the transition loss and  $I^2R$  loss terms in the bottom MOSFET are comparable, so best efficiency is obtained by choosing a MOSFET that optimizes both  $R_{DS(ON)}$  and  $C_{MILLER}$ . Since there is no transition loss term in the synchronous MOSFET, however, optimal efficiency is obtained by minimizing  $R_{DS(ON)}$ —by using larger MOSFETs or paralleling multiple MOSFETs.

Multiple MOSFETs can be used in parallel to lower  $R_{DS(ON)}$  and meet the current and thermal requirements if desired. The LTC3813 contains large low impedance drivers capable of driving large gate capacitances without significantly slowing transition times. In fact, when driving MOSFETs with very low gate charge, it is sometimes helpful to slow down the drivers by adding small gate resistors ( $10\Omega$  or less) to reduce noise and EMI caused by the fast transitions.

## APPLICATIONS INFORMATION

### Operating Frequency

The choice of operating frequency is a tradeoff between efficiency and component size. Low frequency operation improves efficiency by reducing MOSFET switching losses but requires larger inductance and/or capacitance in order to maintain low output ripple voltage.

The operating frequency of LTC3813 applications is determined implicitly by the one-shot timer that controls the on-time  $t_{OFF}$  of the synchronous MOSFET switch. The on-time is set by the current into the  $I_{OFF}$  pin and the voltage at the  $V_{OFF}$  pin according to:

$$t_{OFF} = \frac{V_{V_{OFF}}}{I_{OFF}} (76\text{pF})$$

Tying a resistor  $R_{OFF}$  from  $V_{OUT}$  to the  $I_{OFF}$  pin yields a synchronous MOSFET on-time inversely proportional to  $V_{OUT}$ . This results in the following operating frequency and also keeps frequency constant as  $V_{OUT}$  ramps up at start-up:

$$f = \frac{V_{IN}}{V_{V_{OFF}} \cdot R_{OFF} (76\text{pF})} \text{ (Hz)}$$

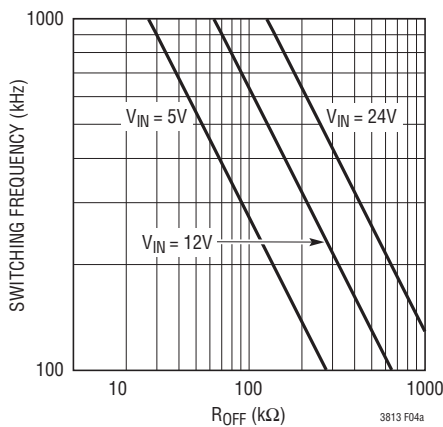

Figure 4a. Switching Frequency vs  $R_{OFF}$  ( $V_{OFF} = INTV_{CC}$ )

The  $V_{OFF}$  pin can be connected to  $INTV_{CC}$  or ground or can be connected to a resistive divider from  $V_{IN}$ . The  $V_{OFF}$  pin has internal clamps that limit its input to the one-shot timer. If the pin is tied below 0.7V, the input to the one-shot is clamped at 0.7V. Similarly, if the pin is tied above 2.4V, the input is clamped at 2.4V. **Note, however, that if the  $V_{OFF}$  pin is connected to a constant voltage, the operating frequency will be proportional to the input voltage  $V_{IN}$ .** Figures 4a and 4b illustrate how  $R_{OFF}$  relates to switching frequency as a function of the input voltage and  $V_{OFF}$  voltage. To hold frequency constant for input voltage changes, tie the  $V_{OFF}$  pin to a resistive divider from  $V_{IN}$ , as shown in Figure 5. Choose the resistor values so that the  $V_{RNG}$  voltage equals about 1.55V at the mid-point of  $V_{IN}$  as follows:

$$V_{IN,MID} = \frac{V_{IN(MAX)} + V_{IN(MIN)}}{2} = 1.55\text{V} \cdot \left(1 + \frac{R1}{R2}\right)$$

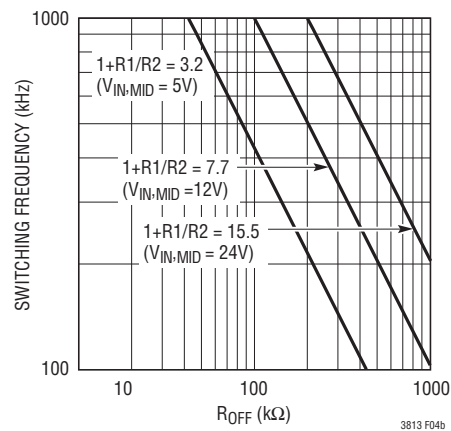

Figure 4b. Switching Frequency vs  $R_{OFF}$  ( $V_{OFF}$  Connected to a Resistor Divider from  $V_{IN}$ )



## APPLICATIONS INFORMATION

With these resistor values, the frequency will remain relatively constant at:

$$f = \frac{1 + R1/R2}{R_{OFF}(76\text{pF})} \text{ (Hz)}$$

for the range of  $0.45V_{IN}$  to  $1.55 \cdot V_{IN}$ , and will be proportional to  $V_{IN}$  outside of this range.

Changes in the load current magnitude will also cause a frequency shift. Parasitic resistance in the MOSFET switches and inductor reduce the effective voltage across the inductance, resulting in increased duty cycle as the load current increases. By shortening the off-time slightly as current increases, constant-frequency operation can be maintained. This is accomplished with a resistor connected from the  $I_{TH}$  pin to the  $I_{OFF}$  pin to increase the  $I_{OFF}$  current slightly as  $V_{ITH}$  increases. The values required will depend on the parasitic resistances in the specific application. A good starting point is to feed about 10% of the  $R_{OFF}$  current with  $R_{ITH}$  as shown in Figure 6.

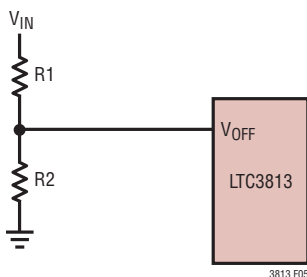

Figure 5.  $V_{OFF}$  Connection to Keep the Operating Frequency Constant as the Input Supply Varies

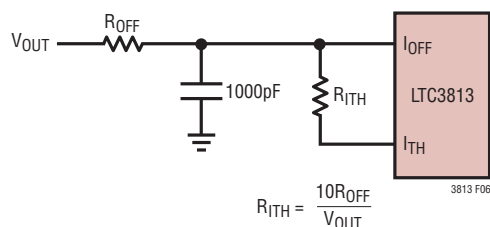

Figure 6. Correcting Frequency Shift with Load Current Changes

### Minimum On-Time and Dropout Operation

The minimum on-time  $t_{ON(MIN)}$  is the smallest amount of time that the LTC3813 is capable of turning on the bottom MOSFET, tripping the current comparator and turning the MOSFET back off. This time is generally about 350ns. The minimum on-time limit imposes a minimum duty cycle of  $t_{ON(MIN)}/(t_{ON(MIN)} + t_{OFF})$ . If the minimum duty cycle is reached, due to a rising input voltage, for example, then the output will rise out of regulation. The maximum input voltage to avoid dropout is:

$$V_{IN(MAX)} = V_{OUT} \frac{t_{OFF}}{t_{ON(MIN)} + t_{OFF}}$$

A plot of maximum duty cycle vs switching frequency is shown in Figure 7.

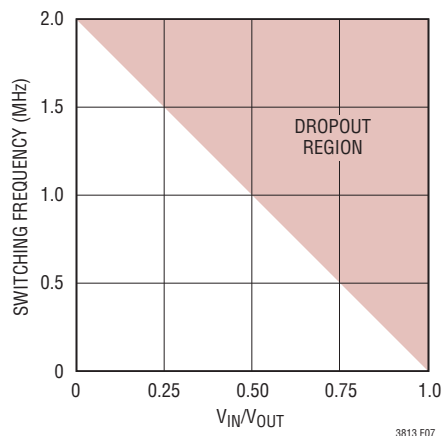

Figure 7. Maximum Duty Cycle vs Switching Frequency

### Inductor Selection

An inductor should be chosen that can carry the maximum input DC current which occurs at the minimum input voltage. The peak-to-peak ripple current is set by the inductance and a good starting point is to choose a ripple current of at least 40% of its maximum value:

$$\Delta I_L = 40\% \cdot \frac{I_{O(MAX)}}{1 - D_{MAX}}$$

## APPLICATIONS INFORMATION

The required inductance can then be calculated to be:

$$L = \frac{V_{IN(MIN)} \cdot D_{MAX}}{f \cdot \Delta I_L}$$

The required saturation of the inductor should be chosen to be greater than the peak inductor current:

$$I_{L(SAT)} \geq \frac{I_{O(MAX)}}{1 - D_{MAX}} + \frac{\Delta I_L}{2}$$

Once the value for L is known, the type of inductor must be selected. High efficiency converters generally cannot afford the core loss found in low cost powdered iron cores, forcing the use of more expensive ferrite, molypermalloy or Kool M $\mu$ ® cores. A variety of inductors designed for high current, low voltage applications are available from manufacturers such as Sumida, Panasonic, Coiltronics, Coilcraft and Toko.

### Schottky Diode D1 Selection

The Schottky diode D1 shown in the front page schematic conducts during the dead time between the conduction of the power MOSFET switches. It is intended to prevent the body diode of the synchronous MOSFET from turning on and storing charge during the dead time, which can cause a modest (about 1%) efficiency loss. The diode can be rated for about one half to one fifth of the full load current since it is on for only a fraction of the duty cycle. The peak reverse voltage that the diode must withstand is equal to the regulator output voltage. In order for the diode to be effective, the inductance between it and the synchronous MOSFET must be as small as possible, mandating that these components be placed adjacently. The diode can be omitted if the efficiency loss is tolerable.

### Output Capacitor Selection

In a boost converter, the output capacitor requirements are demanding due to the fact that the current waveform is pulsed. The choice of component(s) is driven by the acceptable ripple voltage which is affected by the ESR, ESL and bulk capacitance as shown in Figure 8e. The total output ripple voltage is:

$$\Delta V_{OUT} = I_{O(MAX)} \left( \frac{1}{f \cdot C_{OUT}} + \frac{ESR}{1 - D_{MAX}} \right)$$

where the first term is due to the bulk capacitance and second term due to the ESR.

For many designs it is possible to choose a single capacitor type that satisfies both the ESR and bulk C requirements for the design. In certain demanding applications, however, the ripple voltage can be improved significantly by connecting two or more types of capacitors in parallel. For example, using a low ESR ceramic capacitor can minimize the ESR step, while an electrolytic capacitor can be used to supply the required bulk C.

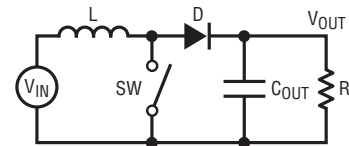

8a. Circuit Diagram

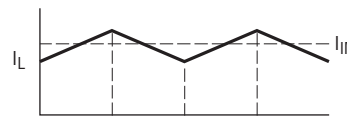

8b. Inductor and Input Currents

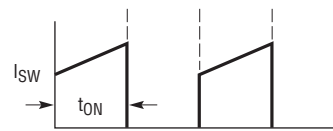

8c. Switch Current

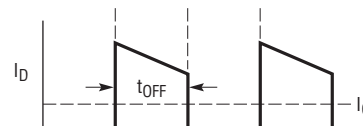

8d. Diode and Output Currents

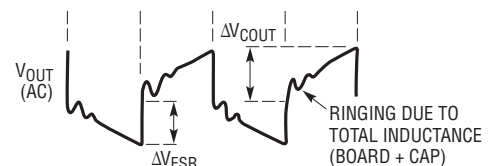

8e. Output Voltage Ripple Waveform

3813 F08

Figure 8. Switching Waveforms for a Boost Converter

## APPLICATIONS INFORMATION

Once the output capacitor ESR and bulk capacitance have been determined, the overall ripple voltage waveform should be verified on a dedicated PC board (see PC Board Layout Checklist section for more information on component placement). Lab breadboards generally suffer from excessive series inductance (due to inter-component wiring), and these parasitics can make the switching waveforms look significantly worse than they would be on a properly designed PC board.

The output capacitor in a boost regulator experiences high RMS ripple currents, as shown in Figure 8d. The RMS output capacitor ripple current is:

$$I_{\text{RMS(COUT)}} \approx I_{\text{O(MAX)}} \cdot \sqrt{\frac{V_{\text{O}} - V_{\text{IN(MIN)}}}{V_{\text{IN(MIN)}}}}$$

Note that the ripple current ratings from capacitor manufacturers are often based on only 2000 hours of life. This makes it advisable to further derate the capacitor or to choose a capacitor rated at a higher temperature than required. Several capacitors may also be placed in parallel to meet size or height requirements in the design.

Manufacturers such as Nichicon, Nippon Chemi-con and Sanyo should be considered for high performance through-hole capacitors. The OS-CON (organic semiconductor dielectric) capacitor available from Sanyo has the lowest product of ESR and size of any aluminum electrolytic at a somewhat higher price. An additional ceramic capacitor in parallel with OS-CON capacitors is recommended to reduce the effect of their lead inductance.

In surface mount applications, multiple capacitors placed in parallel may be required to meet the ESR, RMS current handling and load step requirements. Dry tantalum, special polymer and aluminum electrolytic capacitors are available in surface mount packages. Special polymer capacitors offer very low ESR but have lower capacitance density than other types. Tantalum capacitors have the highest capacitance density but it is important to only use types that have been surge tested for use in switching power supplies. Several excellent surge-tested choices are the AVX TPS and TPSV or the KEMET T510 series. Aluminum electrolytic capacitors have significantly higher ESR, but

can be used in cost-driven applications providing that consideration is given to ripple current ratings and long term reliability. Other capacitor types include Panasonic SP and Sanyo POSCAPs. In applications with  $V_{\text{OUT}} > 30\text{V}$ , however, choices are limited to aluminum electrolytic and ceramic capacitors.

### Input Capacitor Selection

The input capacitor of a boost converter is less critical than the output capacitor, due to the fact that the inductor is in series with the input and the input current waveform is continuous (see Figure 8b). The input voltage source impedance determines the size of the input capacitor, which is typically in the range of  $10\mu\text{F}$  to  $100\mu\text{F}$ . A low ESR capacitor is recommended though not as critical as for the output capacitor.

The RMS input capacitor ripple current for a boost converter is:

$$I_{\text{RMS(CIN)}} = 0.3 \cdot \frac{V_{\text{IN(MIN)}}}{L \cdot f} \cdot D_{\text{MAX}}$$

Please note that the input capacitor can see a very high surge current when a battery is suddenly connected to the input of the converter and solid tantalum capacitors can fail catastrophically under these conditions. **Be sure to specify surge-tested capacitors!**

### Output Voltage

The LTC3813 output voltage is set by a resistor divider according to the following formula:

$$V_{\text{OUT}} = 0.8\text{V} \left( 1 + \frac{R_{\text{FB1}}}{R_{\text{FB2}}} \right)$$

The external resistor divider is connected to the output as shown in the Functional Diagram, allowing remote voltage sensing. The resultant feedback signal is compared with the internal precision 800mV voltage reference by the error amplifier. The internal reference has a guaranteed tolerance of  $<1\%$ . Tolerance of the feedback resistors will add additional error to the output voltage. 0.1% to 1% resistors are recommended.

## APPLICATIONS INFORMATION

### Input Voltage Undervoltage Lockout

A resistor divider connected from the input supply to the UVIN pin (see Functional Diagram) is used to program the input supply undervoltage lockout thresholds. When the rising voltage at UVIN reaches 0.88V, the LTC3813 turns on, and when the falling voltage at UVIN drops below 0.8V, the LTC3813 is shut down—providing 10% hysteresis. The input voltage UVLO thresholds are set by the resistor divider according to the following formulas:

$$V_{IN,FALLING} = 0.8V \cdot \left( 1 + \frac{R_{UV1}}{R_{UV2}} \right)$$

and

$$V_{IN,RISING} = 0.88V \cdot \left( 1 + \frac{R_{UV1}}{R_{UV2}} \right)$$

If input supply undervoltage lockout is not needed, it can be disabled by connecting UVIN to INTV<sub>CC</sub>.

### Top MOSFET Driver Supply (C<sub>B</sub>, D<sub>B</sub>)

An external bootstrap capacitor C<sub>B</sub> connected to the BOOST pin supplies the gate drive voltage for the topside MOSFET. This capacitor is charged through diode D<sub>B</sub> from DRV<sub>CC</sub> when the switch node is low. When the top MOSFET turns on, the switch node rises to V<sub>OUT</sub> and the BOOST pin rises to approximately V<sub>OUT</sub> + DRV<sub>CC</sub>. The boost capacitor needs to store about 100x the gate charge required by the top MOSFET. In most applications, 0.1μF to 0.47μF, X5R or X7R dielectric capacitor is adequate.

The reverse breakdown of the external diode, D<sub>B</sub>, must be greater than V<sub>OUT</sub>. Another important consideration for the external diode is the reverse recovery and reverse leakage, either of which may cause excessive reverse current to flow at full reverse voltage. If the reverse current times reverse voltage exceeds the maximum allowable power dissipation, the diode may be damaged. For best results, use an ultrafast recovery diode such as the MMDL770T1.

### Bottom MOSFET Driver Return Supply (BGRTN)

The bottom gate driver, BG, switches from DRV<sub>CC</sub> to BGRTN where BGRTN can be a voltage between ground and -5V. Why not just keep it simple and always connect

BGRTN to ground? In high voltage switching converters, the switch node dV/dt can be many volts/ns, which will pull up on the gate of the bottom MOSFET through its Miller capacitance. If this Miller current, times the internal gate resistance of the MOSFET plus the driver resistance, exceeds the threshold of the FET, shoot-through will occur. By using a negative supply on BGRTN, the BG can be pulled below ground when turning the bottom MOSFET off. This provides a few extra volts of margin before the gate reaches the turn-on threshold of the MOSFET. Be aware that the maximum voltage difference between DRV<sub>CC</sub> and BGRTN is 14V. If, for example, V<sub>BGRTN</sub> = -2V, the maximum voltage on DRV<sub>CC</sub> pin is now 12V instead of 14V.

### IC/MOSFET Driver Supplies (INTV<sub>CC</sub> and DRV<sub>CC</sub>)

The LTC3813 drivers are supplied from the DRV<sub>CC</sub> pin and the LTC3813 internal circuits from INTV<sub>CC</sub> pin (see Figure 1). These pins have an operating range between 6.2V and 14V. If the input voltage or another supply is not available in this voltage range, two internal regulators are provided to simplify the generation of this IC/driver supply voltage as described in the next sections.

### The N<sub>DRV</sub> Pin Regulator

The N<sub>DRV</sub> pin controls the gate of an external NMOS as shown in Figure 9b and can be used to generate a regulated 10V supply from V<sub>IN</sub> or V<sub>OUT</sub>. Since the NMOS is external, it can be chosen with a BV<sub>DSS</sub> or power rating as high as necessary to safely derive power from a high voltage input or output voltage. In order to generate an INTV<sub>CC</sub> supply that is always above the 6.2V UV threshold, the supply connected to the drain must be greater than 6.2V + R<sub>NDRV</sub> • 40μA + V<sub>T</sub>.

### The EXT<sub>CC</sub> Pin Regulator

A second low dropout regulator is available for voltages ≤ 15V. When a supply that is greater than 6.7V is connected to the EXT<sub>CC</sub> pin, the internal LDO will regulate 10V on INTV<sub>CC</sub> from the EXT<sub>CC</sub> pin voltage and will also disable the N<sub>DRV</sub> pin regulator. This regulator is disabled when the IC is shut down, when INTV<sub>CC</sub> < 6.2V, or when EXT<sub>CC</sub> < 6.7V.

## APPLICATIONS INFORMATION

### Using the INTV<sub>CC</sub> Regulators

One, both or neither of these regulators can be used to generate the 10V IC/driver supply depending on the circuit requirements, available supplies, and the voltage range of  $V_{IN}$  or  $V_{OUT}$ . Deriving the 10V supply from  $V_{IN}$  is more efficient, however deriving it from  $V_{OUT}$  has the advantage of maintaining regulation of  $V_{OUT}$  when  $V_{IN}$  drops below the UV threshold. Four possible configurations are shown in Figures 9a through 9d, and are described as follows:

1. Figure 9a. If the  $V_{IN}$  voltage or another low voltage supply between 6.2V and 14V is available, the simplest approach is to connect this supply directly to the INTV<sub>CC</sub> and DRV<sub>CC</sub> pins. The internal regulators are disabled by shorting NDRV and EXTV<sub>CC</sub> to INTV<sub>CC</sub>.
2. Figure 9b. If  $V_{IN(MAX)} > 14V$ , an external NMOS connected to the NDRV pin can be used to generate 10V from  $V_{IN}$ .  $V_{IN(MIN)}$  must be  $> 6.2V + R_{NDRV} \cdot 40\mu A + V_T$

to keep INTV<sub>CC</sub> above the UV threshold and the  $BV_{DSS}$  of the external NMOS must be chosen to be greater than  $V_{IN(MAX)}$ . The EXTV<sub>CC</sub> regulator is disabled by grounding the EXTV<sub>CC</sub> pin.

3. Figure 9c. If the  $V_{IN(MAX)} < 14.7V$  and  $V_{IN}$  is allowed to fall below 6.2V without disrupting the boost converter operation, use this configuration. The INTV<sub>CC</sub> supply is derived from  $V_{IN}$  until the  $V_{OUT} > 6.7V$ . Once INTV<sub>CC</sub> is derived from  $V_{OUT}$ ,  $V_{IN}$  can fall below the 6V UV threshold without losing regulation of  $V_{OUT}$ . Note that in this configuration,  $V_{IN}$  must be  $> 7V$  at least long enough to start up the LTC3813 and charge  $V_{OUT} > 6.7V$ . Also, since  $V_{OUT}$  is connected to the EXTV<sub>CC</sub> pin, this configuration is limited to  $V_{OUT} < 15V$ .
4. Figure 9d. Similar to configuration 3 except that  $V_{OUT}$  is allowed to be  $> 15V$  since  $V_{OUT}$  is connected to an external NMOS with appropriately rated  $BV_{DSS}$ .  $V_{IN}$  has same start-up requirement as 3.

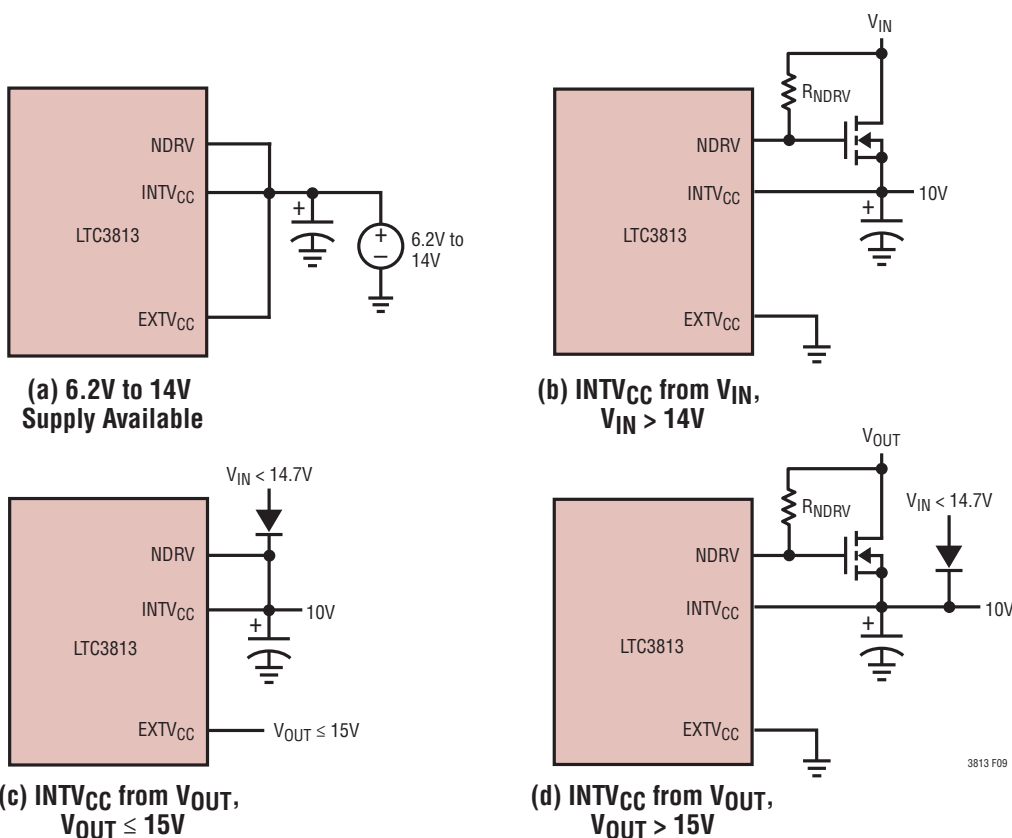

Figure 9. Four Possible Ways to Generate INTV<sub>CC</sub> Supply

## APPLICATIONS INFORMATION

### Power Dissipation Considerations

Applications using large MOSFETs and high frequency of operation may result in a large  $DRV_{CC}/INTV_{CC}$  supply current. Therefore, when using the linear regulators, it is necessary to verify that the resulting power dissipation is within the maximum limits. The  $DRV_{CC}/INTV_{CC}$  supply current consists of the MOSFET gate current plus the LTC3813 quiescent current:

$$I_{CC} = (f)(Q_{G(TOP)} + Q_{G(BOTTOM)}) + 3mA$$

When using the internal LDO regulator, the power dissipation is internal so the rise in junction temperature can be estimated from the equation given in Note 2 of the Electrical Characteristics as follows:

$$T_J = T_A + I_{EXTVCC} \cdot (V_{EXTVCC} - V_{INTVCC})(100^\circ C/W)$$

and must not exceed 125°C.

Likewise, if the external NMOS regulator is used, the worst case power dissipation is calculated to be:

$$P_{MOSFET} = (V_{DRAIN(MAX)} - 10V) \cdot I_{CC}$$

and can be used to properly size the device.

### FEEDBACK LOOP/COMPENSATION

#### Introduction

In a typical LTC3813 circuit, the feedback loop consists of two sections: the modulator/output stage and the feedback amplifier/compensation network. The modulator/output stage consists of the current sense component and internal current comparator, the power MOSFET switches and drivers, and the output filter and load. The transfer function of the modulator/output stage for a boost converter consists of an output capacitor pole,  $R_L C_{OUT}$ , and an ESR zero,  $R_{ESR} C_{OUT}$ , and also a “right-half plane” zero,  $(R_L/L)(V_{IN}^2/V_{OUT}^2)$ . It has a gain/phase curve that is typically like the curve shown in Figure 10 and is expressed mathematically in the following equation.

$$H(s) = \frac{V_{OUT}(s)}{V_{ITH}(s)} = \left( \frac{R_L \cdot V_{IN} \cdot V_{SENSE(MAX)}}{2.4 \cdot V_{OUT} \cdot R_{DS(ON)}} \right) \cdot \left( \frac{1+s \cdot R_{ESR} \cdot C_{OUT}}{1+s \cdot R_L \cdot C_{OUT}} \right) \cdot \left( 1-s \cdot \frac{L}{R_L} \cdot \frac{V_{OUT}^2}{V_{IN}^2} \right) \quad (1)$$

$$s = j2\pi f$$

This portion of the power supply is pretty well out of the user’s control since the current sense is chosen based on maximum output load, and the output capacitor is usually chosen based on load regulation and ripple requirements without considering AC loop response. The feedback amplifier, on the other hand, gives us a handle on which to adjust the AC response. The goal is to have an 180° phase shift at DC so the loop regulates and less than 360° phase shift at the point where the loop gain falls below 0dB, i.e., the crossover frequency, with as much gain as possible at frequencies below the crossover frequency. Since the feedback amplifier adds an additional 90° phase shift to the phase shift already present from the modulator/output stage, some phase boost is required at the crossover frequency to achieve good phase margin. The design procedure (described in more detail in the next section) is to (1) obtain a gain/phase plot of modulator/output stage, (2) choose a crossover frequency and the required phase boost, and (3) calculate the compensation network.

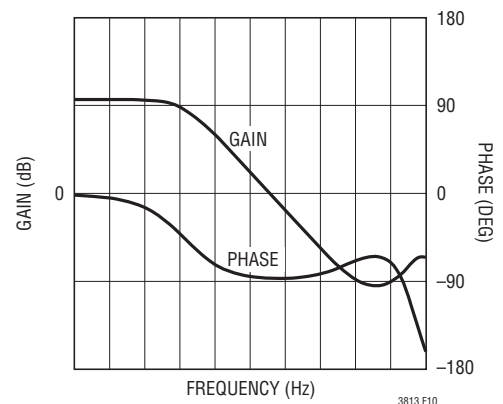

Figure 10. Bode Plot of Boost Modulator/Output Stage

## APPLICATIONS INFORMATION

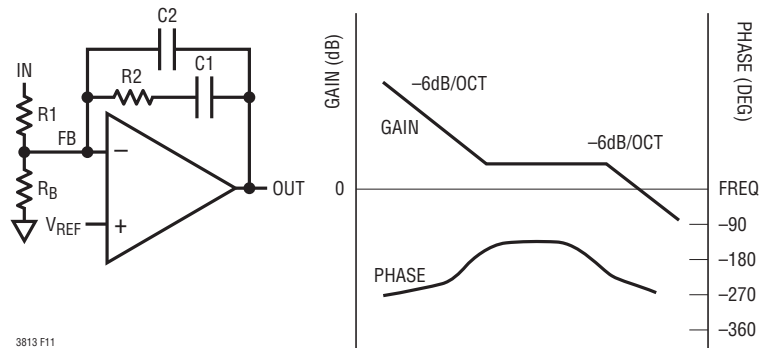

Figure 11. Type 2 Schematic and Transfer Function

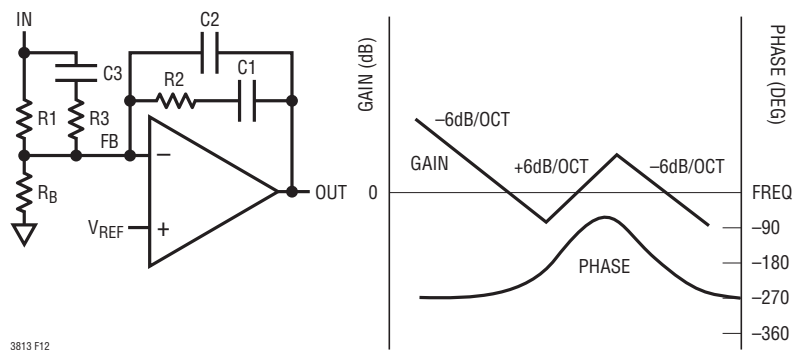

Figure 12. Type 3 Schematic and Transfer Function

The two types of compensation networks, Type 2 and Type 3 are shown in Figures 11 and 12. When component values are chosen properly, these networks provide a “phase bump” at the crossover frequency. Type 2 uses a single pole-zero pair to provide up to about  $60^\circ$  of phase boost while Type 3 uses two poles and two zeros to provide up to  $150^\circ$  of phase boost.

The compensation of boost converters are complicated by two factors: the RHP zero and the dependence of the loop gain on the duty cycle. The RHP zero adds additional phase lag and gain. The phase lag degrades phase margin and the added gain keeps the gain high typically in the frequency region where the user is trying the roll off the gain below 0dB. This often forces the user to choose a crossover frequency at a lower frequency than originally desired. The duty cycle effect of gain (see above transfer function) causes the phase margin and crossover frequency to be dependent on the input supply voltage which may cause problems if the input voltage varies over a wide range since the compensation network can only be optimized

for a specific crossover frequency. These two factors usually can be overcome if the crossover frequency is chosen low enough.

### Feedback Component Selection

Selecting the R and C values for a typical Type 2 or Type 3 loop is a nontrivial task. The applications shown in this data sheet show typical values, optimized for the power components shown. They should give acceptable performance with similar power components, but can be way off if even one major power component is changed significantly. Applications that require optimized transient response will require recalculation of the compensation values specifically for the circuit in question. The underlying mathematics are complex, but the component values can be calculated in a straightforward manner if we know the gain and phase of the modulator at the crossover frequency.

Modulator gain and phase can be obtained in one of three ways: measured directly from a breadboard, or if

3813fb

## APPLICATIONS INFORMATION

the appropriate parasitic values are known, simulated or generated from the modulator transfer function. Measurement will give more accurate results, but simulation or transfer function can often get close enough to give a working system. To measure the modulator gain and phase directly, wire up a breadboard with an LTC3813 and the actual MOSFETs, inductor and input and output capacitors that the final design will use. This breadboard should use appropriate construction techniques for high speed analog circuitry: bypass capacitors located close to the LTC3813, no long wires connecting components, appropriately sized ground returns, etc. Wire the feedback amplifier with a 0.1 $\mu$ F feedback capacitor from I<sub>TH</sub> to FB and a 10k to 100k resistor from V<sub>OUT</sub> to FB. Choose the bias resistor (R<sub>B</sub>) as required to set the desired output voltage. Disconnect R<sub>B</sub> from ground and connect it to a signal generator or to the source output of a network analyzer to inject a test signal into the loop. Measure the gain and phase from the I<sub>TH</sub> pin to the output node at the positive terminal of the output capacitor. Make sure the analyzer's input is AC coupled so that the DC voltages present at both the I<sub>TH</sub> and V<sub>OUT</sub> nodes do not corrupt the measurements or damage the analyzer.

If breadboard measurement is not practical, mathematical software such as MATHCAD or MATLAB can be used to generate plots from the transfer function given in equation 1. A SPICE simulation can also be used to generate approximate gain/phase curves. Plug the expected capacitor, inductor and MOSFET values into the following SPICE deck and generate an AC plot of V<sub>OUT</sub>/V<sub>ITH</sub> with gain in dB and phase in degrees. Refer to your SPICE manual for details of how to generate this plot.

```
*This file simulates a simplified model of
the LTC3813 for generating a v(out)/(vith)
or a v(out)/v(outin) bode plot
```

```
.param vout=24
.param vin=12
.param L=10u
.param cout=270u
.param esr=.018
.param rload=24
*
```

```
.param rdson=0.02
.param Vrng=1
.param vsnsmax={0.173*Vrng-0.026}
.param K={vsnsmax/rdson/1.2}
.param wz={1/esr/cout}
.param wp={2/rload/cout}
*
* Feedback Amplifier
rfb1 outin vfb 29k
rfb2 vfb 0 1k
eithx ithx 0 laplace {0.8-v(vfb)} =
    {1/(1+s/1000)}
eith ith 0 value={limit(1e6*v(ithx),0,2.4)}
cc1 ith vfb 100p
cc2 ith x1 0.01u
rc x1 vfb 100k
*
* Modulator/Output Stage
eout out 0 laplace {v(ith)} =
    {0.5*K*Rload*vin/vout *(1+s/wz)/(1+s/wp)
    *(1-s*L/Rload*vout*vout/vin/vin)}
rload out 0 {rload}
*
vstim out outin dc=0 ac=10m; ac stimulus
.ac dec 100 10 10meg
.probe
.end
```

With the gain/phase plot in hand, a loop crossover frequency can be chosen. Usually the curves look something like Figure 10. Choose the crossover frequency about 25% of the switching frequency for maximum bandwidth. Although it may be tempting to go beyond  $f_{SW}/4$ , remember that significant phase shift occurs at half the switching frequency that isn't modeled in the above H(s) equation and PSPICE code. Note the gain (GAIN, in dB) and phase (PHASE, in degrees) at this point. The desired feedback amplifier gain will be  $-GAIN$  to make the loop gain at 0dB at this frequency. Now calculate the needed phase boost, assuming 60° as a target phase margin:

$$BOOST = - (PHASE + 30^\circ)$$

If the required BOOST is less than 60°, a Type 2 loop can be used successfully, saving two external components. BOOST values greater than 60° usually require Type 3 loops for satisfactory performance.



## APPLICATIONS INFORMATION

Finally, choose a convenient resistor value for R1 (10k is usually a good value). Now calculate the remaining values:

(K is a constant, used in the calculations)

f = chosen crossover frequency

$G = 10^{(GAIN/20)}$  (this converts GAIN in dB to G in absolute gain)

TYPE 2 Loop:

$$K = \tan\left(\frac{BOOST}{2} + 45^\circ\right)$$

$$C2 = \frac{1}{2\pi \cdot f \cdot G \cdot K \cdot R1}$$

$$C1 = C2(K^2 - 1)$$

$$R2 = \frac{K}{2\pi \cdot f \cdot C1}$$

$$R_B = \frac{V_{REF}(R1)}{V_{OUT} - V_{REF}}$$

TYPE 3 Loop:

$$K = \tan^2\left(\frac{BOOST}{4} + 45^\circ\right)$$

$$C2 = \frac{1}{2\pi \cdot f \cdot G \cdot R1}$$

$$C1 = C2(K - 1)$$

$$R2 = \frac{\sqrt{K}}{2\pi \cdot f \cdot C1}$$

$$R3 = \frac{R1}{K - 1}$$

$$C3 = \frac{1}{2\pi f \sqrt{K} \cdot R3}$$

$$R_B = \frac{V_{REF}(R1)}{V_{OUT} - V_{REF}}$$

SPICE or mathematical software can be used to generate the gain/phase plots for the compensated power supply to do a sanity check on the component values before trying them out on the actual hardware. For software, use the following transfer function:

$$T(s) = A(s)H(s)$$

where H(s) was given in equation 1 and A(s) depends on compensation circuit used:

Type 2:

$$A(s) = \frac{1 + s \cdot R3 \cdot C2}{s \cdot R1 \cdot (C2 + C3) \cdot \left(1 + s \cdot R3 \cdot \frac{C2 \cdot C3}{C2 + C3}\right)}$$

Type 3:

$$A(s) = \frac{1}{s \cdot R1 \cdot (C2 + C3)} \cdot \frac{(1 + s \cdot (R1 + R3) \cdot C3) \cdot (1 + s \cdot R2 \cdot C1)}{(1 + s \cdot R3 \cdot C3) \cdot \left(1 + s \cdot R2 \cdot \frac{C1 \cdot C2}{C1 + C2}\right)}$$

For SPICE, simulate the previous PSPICE code with calculated compensation values entered and generate a gain/phase plot of  $V_{OUT}/V_{OUTIN}$ .

### Fault Conditions: Current Limit

The maximum inductor current is inherently limited in a current mode controller by the maximum sense voltage. In the LTC3813, the maximum sense voltage is controlled by the voltage on the  $V_{RNG}$  pin. With peak current control, the maximum sense voltage and the sense resistance determine the maximum allowed inductor peak current. The corresponding output current limit is:

$$I_{LIMIT} = \frac{V_{SNS(MAX)}}{R_{DS(ON)} \rho_T} - \frac{1}{2} \Delta I_L$$

The current limit value should be checked to ensure that  $I_{LIMIT(MIN)} > I_{OUT(MAX)}$ . The minimum value of current limit generally occurs at the lowest  $V_{IN}$  at the highest ambient temperature, conditions that cause the largest power loss in the converter. Note that it is important to check for

## APPLICATIONS INFORMATION

self-consistency between the assumed MOSFET junction temperature and the resulting value of  $I_{LIMIT}$  which heats the MOSFET switches.

Caution should be used when setting the current limit based upon the  $R_{DS(ON)}$  of the MOSFETs. The maximum current limit is determined by the minimum MOSFET on-resistance. Data sheets typically specify nominal and maximum values for  $R_{DS(ON)}$ , but not a minimum. A reasonable assumption is that the minimum  $R_{DS(ON)}$  lies the same percentage below the typical value as the maximum lies above it. Consult the MOSFET manufacturer for further guidelines.

Note that in a boost mode architecture, it is only possible to provide protection for “soft” shorts where  $V_{OUT} > V_{IN}$ . For hard shorts, the inductor current is limited only by the input supply capability.

### Soft-Start

The LTC3813 has the ability to soft-start with a capacitor connected to the SS pin. The LTC3813 is put in a low quiescent current shutdown state ( $I_Q \sim 240\mu A$ ) if the SHDN pin voltage is below 1.5V. The SS pin is actively pulled to ground in this shutdown state. Once the SHDN pin voltage is above 1.5V, the LTC3813 is powered up. A soft-start current of  $1.4\mu A$  then starts to charge the soft-start capacitor  $C_{SS}$ . Soft-start is achieved by limiting the maximum output current of the controller by controlling the ramp rate of the  $I_{TH}$  voltage. The total soft-start time can be calculated as:

$$t_{SOFTSTART} \leq 2.4 \cdot \frac{C_{SS}}{1.4\mu A}$$

### Phase-Locked Loop and Frequency Synchronization

The LTC3813 has a phase-locked loop comprised of an internal voltage controlled oscillator and phase detector. This allows the top MOSFET turn-on to be locked to the rising edge of an external source. The frequency range of the voltage controlled oscillator is  $\pm 30\%$  around the center frequency  $f_0$ . The center frequency is the operating frequency discussed in the Operating Frequency section.

The LTC3813 incorporates a pulse detection circuit that will detect a clock on the SYNC pin. In turn, it will turn on the phase-locked loop function. The pulse width of the clock has to be greater than 400ns and the amplitude of the clock should be greater than 2V.

The internal oscillator locks to the external clock after the second clock transition is received. If an external clock transition is not detected for three successive periods, the internal oscillator will revert to the frequency programmed by the  $R_{OFF}$  resistor.

During the start-up phase, phase-locked loop function is disabled. When LTC3813 is not in synchronization mode, PLL/LPF pin voltage is set to around 1.215V. Frequency synchronization is accomplished by changing the internal off-time current according to the voltage on the PLL/LPF pin.

The phase detector used is an edge sensitive digital type which provides zero degrees phase shift between the external and internal pulses. This type of phase detector will not lock up on input frequencies close to the harmonics of the  $V_{CO}$  center frequency. The PLL hold-in range,  $\Delta f_H$ , is equal to the capture range,  $\Delta f_C$ :

$$\Delta f_H = \Delta f_C = \pm 0.3 f_0$$

The output of the phase detector is a complementary pair of current sources charging or discharging the external filter network on the PLL/LPF pin. A simplified block diagram is shown in Figure 13.

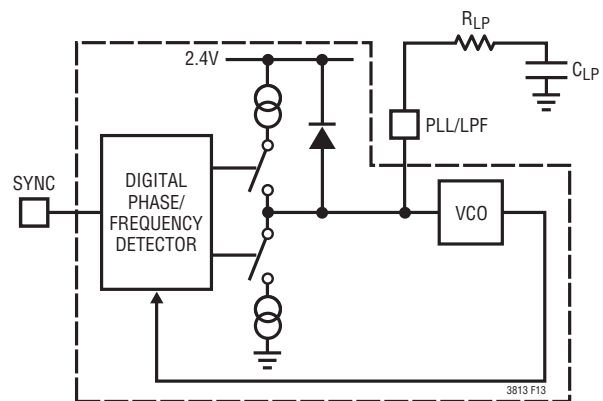

Figure 13. Phase-Locked Loop Block Diagram

## APPLICATIONS INFORMATION

If the external frequency ( $f_{\text{SYNC}}$ ) is greater than the oscillator frequency  $f_0$ , current is sourced continuously, pulling up the PLL/LPF pin. When the external frequency is less than  $f_0$ , current is sunk continuously, pulling down the PLL/LPF pin. If the external and internal frequencies are the same but exhibit a phase difference, the current sources turn on for an amount of time corresponding to the phase difference. Thus the voltage on the PLL/LPF pin is adjusted until the phase and frequency of the external and internal oscillators are identical. At this stable operating point the phase comparator output is open and the filter capacitor  $C_{\text{LP}}$  holds the voltage. The LTC3813 SYNC pin must be driven from a low impedance source such as a logic gate located close to the pin.

The loop filter components ( $C_{\text{LP}}$ ,  $R_{\text{LP}}$ ) smooth out the current pulses from the phase detector and provide a stable input to the voltage controlled oscillator. The filter components  $C_{\text{LP}}$  and  $R_{\text{LP}}$  determine how fast the loop acquires lock. Typically  $R_{\text{LP}} = 10\text{k}\Omega$  and  $C_{\text{LP}}$  is  $0.01\mu\text{F}$  to  $0.1\mu\text{F}$ .

### Pin Clearance/Creepage Considerations

The LTC3813 is available in the G28 package which has  $0.0106''$  spacing between adjacent pins. To maximize PC board trace clearance between high voltage pins, the LTC3813 has three unconnected pins between all adjacent high voltage and low voltage pins, providing  $4(0.0106'') = 0.042''$  clearance which will be sufficient for most applications up to 100V. For more information, refer to the printed circuit board design standards described in IPC-2221 ([www.ipc.org](http://www.ipc.org)).

### Efficiency Considerations

The percent efficiency of a switching regulator is equal to the output power divided by the input power times 100%. It is often useful to analyze individual losses to determine what is limiting the efficiency and which change would produce the most improvement. Although all dissipative elements in the circuit produce losses, four main sources account for most of the losses in LTC3813 circuits:

1. DC  $I^2R$  losses. These arise from the resistances of the MOSFETs, inductor and PC board traces and cause the efficiency to drop at high input currents. The input

current is maximum at maximum output current and minimum input voltage. The average input current flows through L, but is chopped between the top and bottom MOSFETs. If the two MOSFETs have approximately the same  $R_{\text{DS(ON)}}$ , then the resistance of one MOSFET can simply be summed with the resistances of L and the board traces to obtain the DC  $I^2R$  loss. For example, if  $R_{\text{DS(ON)}} = 0.01\Omega$  and  $R_{\text{L}} = 0.005\Omega$ , the loss will range from 15mW to 1.5W as the input current varies from 1A to 10A.

2. Transition loss. This loss arises from the brief amount of time the bottom MOSFET spends in the saturated region during switch node transitions. It depends upon the output voltage, load current, driver strength and MOSFET capacitance, among other factors. The loss is significant at output voltages above 20V and can be estimated from the second term of the  $P_{\text{MAIN}}$  equation found in the Power MOSFET Selection section. When transition losses are significant, efficiency can be improved by lowering the frequency and/or using a bottom MOSFET(s) with lower  $C_{\text{RSS}}$  at the expense of higher  $R_{\text{DS(ON)}}$ .
3.  $\text{INTV}_{\text{CC}}/\text{DRV}_{\text{CC}}$  current. This is the sum of the MOSFET driver and control currents. Control current is typically about 3mA and driver current can be calculated by:  $I_{\text{GATE}} = f(Q_{\text{G(TOP)}} + Q_{\text{G(BOT)}})$ , where  $Q_{\text{G(TOP)}}$  and  $Q_{\text{G(BOT)}}$  are the gate charges of the top and bottom MOSFETs. This loss is proportional to the supply voltage that  $\text{INTV}_{\text{CC}}/\text{DRV}_{\text{CC}}$  is derived from, i.e.,  $V_{\text{IN}}$ ,  $V_{\text{OUT}}$  or an external supply connected to  $\text{INTV}_{\text{CC}}/\text{DRV}_{\text{CC}}$ .
4.  $C_{\text{OUT}}$  loss. The output capacitor has the difficult job of filtering the large RMS input current out of the synchronous MOSFET. It must have a very low ESR to minimize the AC  $I^2R$  loss.

Other losses, including  $C_{\text{IN}}$  ESR loss, Schottky diode D1 conduction loss during dead time and inductor core loss generally account for less than 2% additional loss. When making adjustments to improve efficiency, the input current is the best indicator of changes in efficiency. If you make a change and the input current decreases, then the efficiency has increased. If there is no change in input current, then there is no change in efficiency.

## APPLICATIONS INFORMATION

### Checking Transient Response

The regulator loop response can be checked by looking at the load transient response. Switching regulators take several cycles to respond to a step in load current. When load step occurs,  $V_{OUT}$  immediately shifts by an amount equal to  $\Delta I_{LOAD}$  (ESR), where ESR is the effective series resistance of  $C_{OUT}$ .  $\Delta I_{LOAD}$  also begins to charge or discharge  $C_{OUT}$  generating a feedback error signal used by the regulator to return  $V_{OUT}$  to its steady-state value. During this recovery time,  $V_{OUT}$  can be monitored for overshoot or ringing that would indicate a stability problem.

### Design Example

As a design example, take a supply with the following specifications:  $V_{IN} = 12V \pm 20\%$ ,  $V_{OUT} = 24V \pm 5\%$ ,  $I_{OUT(MAX)} = 5A$ ,  $f = 250kHz$ . Since  $V_{IN}$  can vary around the 12V nominal value, connect a resistive divider from  $V_{IN}$  to  $V_{OFF}$  to keep the frequency independent of  $V_{IN}$  changes:

$$\frac{R1}{R2} = \frac{12V}{1.55V} - 1 = 6.74$$

Choose  $R1 = 133k$  and  $R2 = 20k$ . Now calculate timing resistor  $R_{OFF}$ :

$$R_{OFF} = \frac{1 + 133k / 20k}{250kHz \cdot 76pF} = 402.6k$$

The duty cycle is:

$$D = 1 - \frac{12V}{24V} = 0.5$$

and the maximum input current is:

$$I_{IN(MAX)} = \frac{5A}{1 - 0.5} = 10A$$

Choose the inductor for about 40% ripple current at the maximum  $V_{IN}$ :

$$L = \frac{12V}{250kHz \cdot 0.4 \cdot 10A} \left( 1 - \frac{12V}{24V} \right) = 6\mu H$$

The peak inductor current is:

$$I_{L(PEAK)} = \frac{5A}{1 - 0.5} + \frac{1}{2}(4A) = 12A$$

Choose the CDEP147 5.9 $\mu$ H inductor with  $I_{SAT} = 16.4A$  at 100°C.

Next, choose the bottom MOSFET switch. Since the drain of the MOSFET will see the full output voltage plus any ringing, choose a 40V MOSFET to provide a margin of safety. The Si7848DP has:

$$\begin{aligned} BV_{DSS} &= 40V \\ R_{DS(ON)} &= 9m\Omega(\text{max})/7.5m\Omega(\text{nom}), \\ \delta &= 0.006/^{\circ}C, \\ C_{MILLER} &= (14nC - 6nC)/20V = 400pF, \\ V_{GS(MILLER)} &= 3.5V, \\ \theta_{JA} &= 20^{\circ}C/W. \end{aligned}$$

This yields a nominal sense voltage of:

$$V_{SNS(NOM)} = \frac{1.7 \cdot 0.0075\Omega \cdot 5A}{1 - 0.5} = 128mV$$

To guarantee proper current limit at worst-case conditions, increase nominal  $V_{SNS}$  by 50% to 190mV. To check if the current limit is acceptable at  $V_{SNS} = 190mV$ , assume a junction temperature of about 30°C above a 70°C ambient ( $\rho_{100^{\circ}C} = 1.4$ ):

$$I_{IN(MAX)} \geq \frac{190mV}{1.4 \cdot 0.009\Omega} - \frac{1}{2} \cdot 4A = 13A$$

$$I_{OUT(MAX)} = I_{IN(MAX)} \cdot (1 - D_{MAX}) = 6.5A$$

and double-check the assumed  $T_J$  in the MOSFET:

$$P_{TOP} = \left( \frac{1}{1 - 0.5} \right) (6.5A)^2 (1.4)(0.009\Omega) = 1.06W$$

$$T_J = 70^{\circ}C + 1.06W \cdot 20^{\circ}C/W = 91^{\circ}C$$

## APPLICATIONS INFORMATION

Verify that the Si7848DP is also a good choice for the bottom MOSFET by checking its power dissipation at current limit and minimum input voltage, assuming a junction temperature of 30°C above a 70°C ambient ( $\rho_{100^\circ\text{C}} = 1.4$ ):

$$P_{\text{BOT}} = 0.5 \left( \frac{6.5\text{A}}{1-0.5} \right)^2 (1.4) (0.009\Omega)$$

$$+ \frac{1}{2} (24\text{V})^2 \left( \frac{6.5\text{A}}{1-0.5} \right) (2) (400\text{pF})$$

$$\cdot \left( \frac{1}{12\text{V} - 3.5\text{V}} + \frac{1}{3.5\text{V}} \right) (250\text{kHz})$$

$$= 1.06\text{W} + 0.30\text{W} = 1.36\text{W}$$

$$T_J = 70^\circ\text{C} + 1.36\text{W} \cdot 20^\circ\text{C}/\text{W} = 97^\circ\text{C}$$

The junction temperature will be significantly less at nominal current, but this analysis shows that careful attention to heat sinking on the board will be necessary in this circuit.

Since  $V_{\text{IN}}$  is always between 6.2V and 14V, it can be connected directly to the  $\text{INTV}_{\text{CC}}$  and  $\text{DRV}_{\text{CC}}$  pins.

$C_{\text{OUT}}$  is chosen for an RMS current rating of about 5A at 85°C. The output capacitors are chosen for a low ESR of 0.018Ω to minimize output voltage changes due to inductor ripple current and load steps. The ripple voltage will be only:

$$\Delta V_{\text{OUT(RIPPLE)}} = (5\text{A}) \left( \frac{1}{250\text{kHz} \cdot 330\mu\text{F}} + \frac{0.018}{1-0.5} \right)$$

$$= 0.25\text{V (about 1\%)}$$

A 0A to 5A load step will cause an output change of up to:

$$\Delta V_{\text{OUT(STEP)}} = \Delta I_{\text{LOAD}} \cdot \text{ESR} = 5\text{A} \cdot 0.018\Omega$$

$$= 90\text{mV}$$

An optional 10μF ceramic output capacitor is included to minimize the effect of ESL in the output ripple. The complete circuit is shown in Figure 14.

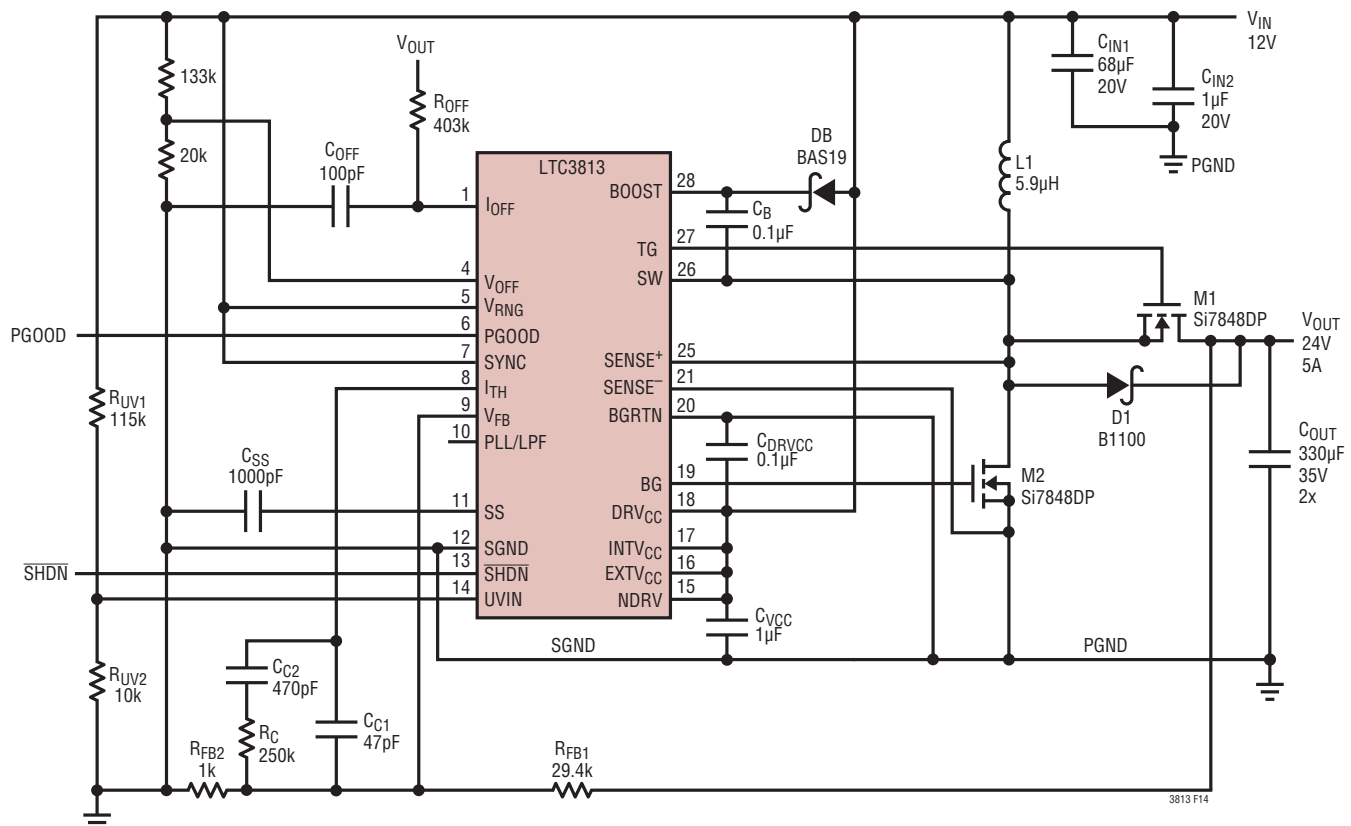

Figure 14. 12V Input Voltage to 24V/5A

## APPLICATIONS INFORMATION

### PC Board Layout Checklist

When laying out a PC board follow one of two suggested approaches. The simple PC board layout requires a dedicated ground plane layer. Also, for higher currents, it is recommended to use a multilayer board to help with heat sinking power components.

- The ground plane layer should not have any traces and it should be as close as possible to the layer with power MOSFETs.
- Place  $C_{IN}$ ,  $C_{OUT}$ , MOSFETs, D1 and inductor all in one compact area. It may help to have some components on the bottom side of the board.
- Use an immediate via to connect the components to ground plane including SGND and PGND of LTC3813. Use several bigger vias for power components.
- Use compact plane for switch node (SW) to improve cooling of the MOSFETs and to keep EMI down.
- Use planes for  $V_{IN}$  and  $V_{OUT}$  to maintain good voltage filtering and to keep power losses low.
- Flood all unused areas on all layers with copper. Flooding with copper will reduce the temperature rise of power component. You can connect the copper areas to any DC net ( $V_{IN}$ ,  $V_{OUT}$ , GND or to any other DC rail in your system).

When laying out a printed circuit board, without a ground plane, use the following checklist to ensure proper operation of the controller.

- Segregate the signal and power grounds. All small signal components should return to the SGND pin at one point which is then tied to the PGND pin close to the source of M2.
- Place M2 as close to the controller as possible, keeping the PGND, BG and SW traces short.
- Connect the input capacitor(s)  $C_{IN}$  close to the power MOSFETs. This capacitor carries the MOSFET AC current.
- Keep the high  $dV/dt$  SW, BOOST and TG nodes away from sensitive small-signal nodes.
- Connect the  $INTV_{CC}$  decoupling capacitor  $C_{VCC}$  closely to the  $INTV_{CC}$  and SGND pins.
- Connect the top driver boost capacitor  $C_B$  closely to the BOOST and SW pins.
- Connect the bottom driver decoupling capacitor  $C_{DRVCC}$  closely to the  $DRV_{CC}$  and BGRTN pins.

# PACKAGE DESCRIPTION

**G Package**  
**28-Lead Plastic SSOP (5.3mm)**  
 (Reference LTC DWG # 05-08-1640)

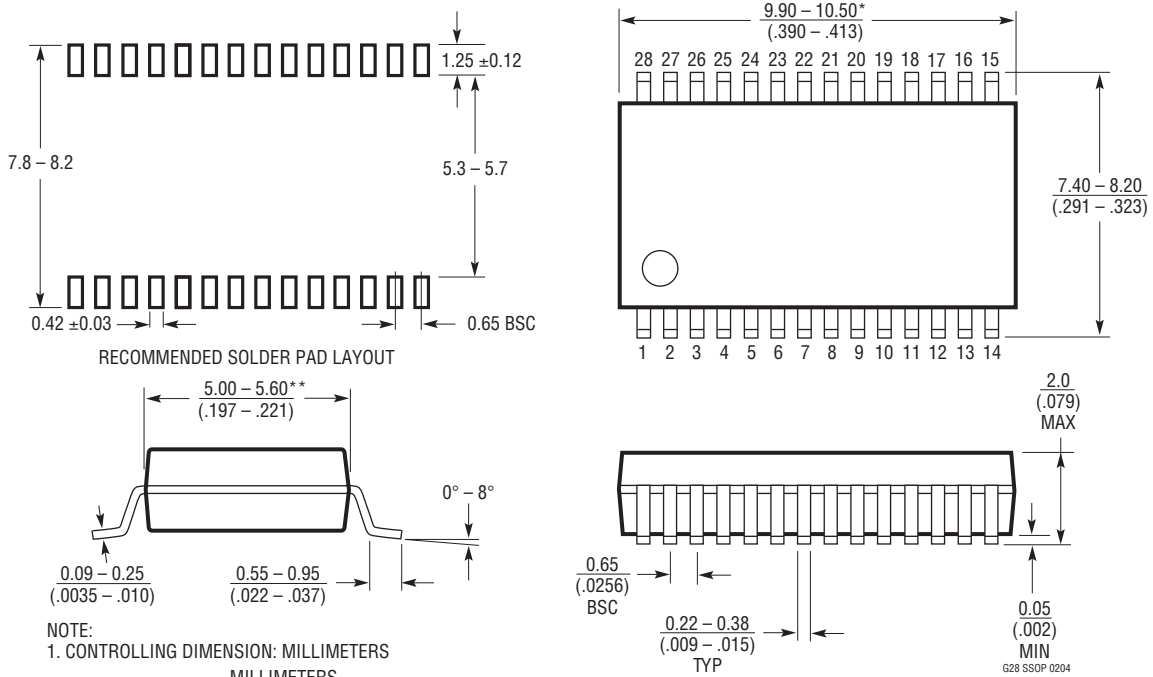

- NOTE:
1. CONTROLLING DIMENSION: MILLIMETERS
  2. DIMENSIONS ARE IN MILLIMETERS (INCHES)
  3. DRAWING NOT TO SCALE
- \*DIMENSIONS DO NOT INCLUDE MOLD FLASH. MOLD FLASH SHALL NOT EXCEED .152mm (.006") PER SIDE
- \*\*DIMENSIONS DO NOT INCLUDE INTERLEAD FLASH. INTERLEAD FLASH SHALL NOT EXCEED .254mm (.010") PER SIDE

G28 SSOP 0204

