

FEATURES

RS-485/RS-422 full duplex transceiver, for high speed motor control applications

16 Mbps data rate

±8 kV ESD protection on RS-485 input/output pins

Complies with ANSI/TIA/EIA-485-A-1998

Open circuit fail-safe

Suitable for 5 V power supply applications

32 nodes on the bus (1 unit load)

Thermal shutdown protection

Operating temperature range: -40°C to +85°C

Packages

Narrow-body 14-lead SOIC

10-lead MSOP

APPLICATIONS

RS-485/RS-422 interfaces

Industrial field networks

High data rate motor control

Multipoint data transmission systems

Single-ended to differential signal conversion

GENERAL DESCRIPTION

The ADM1491E is an RS-485 transceiver with ±8 kV ESD protection and is suitable for high speed, full-duplex communication on multipoint transmission lines. In particular, the ADM1491E is designed for use in motor control applications requiring communications at data rates up to 16 Mbps.

The ADM1491E is designed for balanced transmission lines and complies with TIA/EIA-485-A-98. The device has a 12 kΩ receiver input impedance for unit load RS-485 operation allowing up to 32 nodes on the bus.

The differential transmitter outputs and receiver inputs feature electrostatic discharge circuitry that provides protection to ±8 kV using the human body model (HBM).

The ADM1491E operates from a single 5 V power supply. Excessive power dissipation caused by bus contention or output shorting is prevented by short-circuit protection and thermal circuitry.

FUNCTIONAL BLOCK DIAGRAM

Figure 1.

Short-circuit protection circuits limit the maximum output current to ±250 mA during fault conditions. A thermal shutdown circuit senses if the die temperature rises above 150°C and forces the driver outputs into a high impedance state under this condition.

The receiver of the ADM1491E contains a fail-safe feature that results in a logic high output state if the inputs are unconnected (floating).

The ADM1491E features extremely fast and closely matched switching times. Minimal driver propagation delays permit transmission at data rates up to 16 Mbps while low skew minimizes EMI interference.

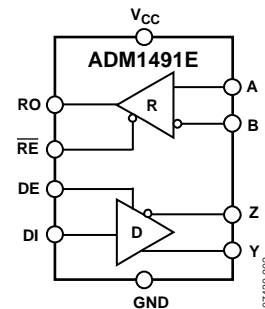
The ADM1491E is fully specified over the commercial and industrial temperature ranges and is available in two packages: a narrow-body 14-lead SOIC and a 10-lead MSOP.

Rev. 0

Information furnished by Analog Devices is believed to be accurate and reliable. However, no responsibility is assumed by Analog Devices for its use, nor for any infringements of patents or other rights of third parties that may result from its use. Specifications subject to change without notice. No license is granted by implication or otherwise under any patent or patent rights of Analog Devices. Trademarks and registered trademarks are the property of their respective owners.

TABLE OF CONTENTS

Features	1	Typical Performance Characteristics	7
Applications.....	1	Test Circuits.....	9
Functional Block Diagram	1	Theory of Operation	10
General Description	1	Truth Tables.....	10
Revision History	2	ESD Transient Protection Scheme	10
Specifications.....	3	Applications Information	12
Timing Specifications	4	Differential Data.....	12
Absolute Maximum Ratings.....	5	Cable and Data Rate.....	12
Thermal Resistance	5	Typical Applications.....	12
ESD Caution.....	5	Outline Dimensions	13
Pin Configurations and Function Descriptions	6	Ordering Guide	13

REVISION HISTORY

12/08—Revision 0: Initial Version

SPECIFICATIONS

4.75 V \leq V_{CC} \leq 5.25 V; all minimum/maximum specifications apply over the entire recommended operation range, unless otherwise noted. All typical specifications are at T_A = 25°C, V_{CC} = 5.0 V, unless otherwise noted.

Table 1.

Parameter	Symbol	Min	Typ	Max	Unit	Test Conditions
SUPPLY CURRENT						
Outputs Enabled	I _{CC1}		1.2	2.0	mA	Outputs unloaded, digital inputs = V _{CC} or GND
Outputs Disabled	I _{CC2}		0.8	1.5	mA	Outputs unloaded, digital inputs = V _{CC} or GND
DRIVER						
Differential Outputs						
Differential Output Voltage, Loaded	V _{OD2}	2.0		5.0	V	R _L = 100 Ω (RS-422), see Figure 19
		1.5		5.0	V	R _L = 54 Ω (RS-485), see Figure 19
	V _{OD3}	1.5		5.0	V	-7 V \leq V _{TEST} \leq +12 V, see Figure 20
$\Delta V_{OD} $ for Complementary Output States	$\Delta V_{OD2} $			0.2	V	R _L = 54 Ω or 100 Ω, see Figure 19
Common-Mode Output Voltage	V _{OC}			3.0	V	R _L = 54 Ω or 100 Ω, see Figure 19
$\Delta V_{OC} $ for Complementary Output States	$\Delta V_{OC} $			0.2	V	R _L = 54 Ω or 100 Ω, see Figure 19
Output Leakage Current (Y, Z)	I _O			100	μA	DE = 0 V, V _{DD} = 0 V or 5 V, V _{IN} = 12 V
	I _O	-100			μA	DE = 0 V, V _{DD} = 0 V or 5 V, V _{IN} = -7 V
Output Short-Circuit Current	I _{OS}			250	mA	-7 V < V _{OUT} < +12 V
Logic Inputs DE, \overline{RE} , DI						
Input Low Voltage	V _{IL}			0.8	V	DE, \overline{RE} , DI
Input High Voltage	V _{IH}	2.0			V	DE, \overline{RE} , DI
Input Current	I _I	-1		+1	μA	DE, \overline{RE} , DI
RECEIVER						
Differential Inputs						
Differential Input Threshold Voltage	V _{TH}	-0.2		+0.2	V	-7 V < V _{CM} < +12 V
Input Voltage Hysteresis	V _{HYS}		30		mV	V _{CM} = 0 V
Input Current (A, B)	I _I			1.0	mA	V _{CM} = 12 V
		-0.8			mA	V _{CM} = -7 V
Line Input Resistance	R _{IN}	12	30		kΩ	-7 V \leq V _{CM} \leq +12 V
Logic Outputs						
Output Voltage Low	V _{OL}			0.4	V	I _{OUT} = +4.0 mA, V _A - V _B = -0.2 V
Output Voltage High	V _{OH}	4.0			V	I _{OUT} = -4.0 mA, V _A - V _B = +0.2 V
Short-Circuit Current				85	mA	
Three-State Output Leakage Current	I _{OZR}			±1	μA	V _{CC} = 5.25 V, 0.4 V < V _{OUT} < 2.4 V

ADM1491E

TIMING SPECIFICATIONS

$T_A = -40^{\circ}\text{C}$ to $+85^{\circ}\text{C}$.

Table 2.

Parameter	Symbol	Min	Typ	Max	Unit	Test Conditions
DRIVER						
Maximum Data Rate		16			Mbps	
Propagation Delay	t_{DPLH}, t_{DPHL}		11	17	ns	$R_L = 54\ \Omega, C_L = 100\ \text{pF}$, see Figure 21 and Figure 2
Driver Output Skew	t_{SKEW}		0.5	2	ns	$R_L = 54\ \Omega, C_L = 100\ \text{pF}$, see Figure 21 and Figure 2, $t_{SKEW} = t_{DPLH} - t_{DPHL} $
Rise Time/Fall Time	t_{DR}, t_{DF}		8	15	ns	$R_L = 54\ \Omega, C_L = 100\ \text{pF}$, see Figure 21 and Figure 2
Enable Time	t_{ZH}, t_{ZL}			20	ns	$R_L = 110\ \Omega, C_L = 50\ \text{pF}$, see Figure 22 and Figure 4
Disable Time	t_{HZ}, t_{LZ}			20	ns	$R_L = 110\ \Omega, C_L = 50\ \text{pF}$, see Figure 22 and Figure 4
RECEIVER						
Propagation Delay	t_{PLH}, t_{PHL}		12	20	ns	$C_L = 15\ \text{pF}$, see Figure 23 and Figure 3
Skew $ t_{PLH} - t_{PHL} $	t_{SKEW}		0.4	2	ns	$C_L = 15\ \text{pF}$, see Figure 23 and Figure 3
Enable Time	t_{ZH}, t_{ZL}			13	ns	$R_L = 1\ \text{k}\Omega, C_L = 15\ \text{pF}$, see Figure 24 and Figure 5
Disable Time	t_{HZ}, t_{LZ}			13	ns	$R_L = 1\ \text{k}\Omega, C_L = 15\ \text{pF}$, see Figure 24 and Figure 5

Timing Diagrams

Switching Characteristics

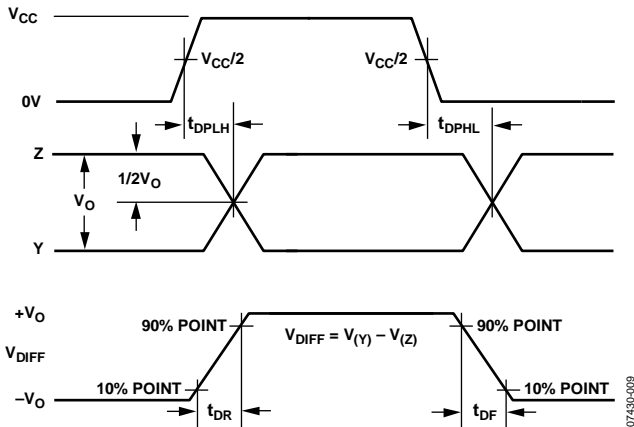

Figure 2. Driver Propagation Delay Rise/Fall Timing

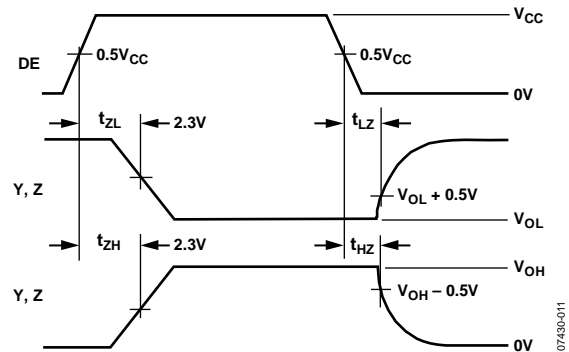

Figure 4. Driver Enable/Disable Timing

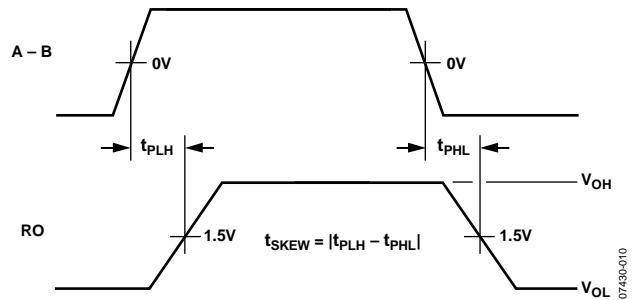

Figure 3. Receiver Propagation Delay Timing

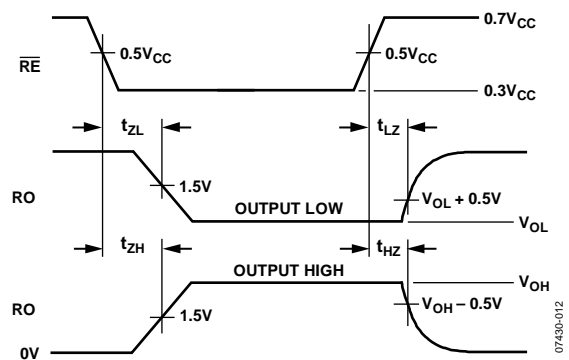

Figure 5. Receiver Enable/Disable Timing

ABSOLUTE MAXIMUM RATINGS

$T_A = 25^\circ\text{C}$, unless otherwise noted.

Table 3.

Parameter	Rating
V_{CC} to GND	-0.3 V to +7 V
Digital I/O Voltage (DE, \overline{RE})	-0.3 V to $V_{CC} + 0.3$ V
Driver Input Voltage (DI)	-0.3 V to $V_{CC} + 0.3$ V
Receiver Output Voltage (RO)	-0.3 V to $V_{CC} + 0.3$ V
Driver Output/Receiver Input Voltage (A, B, Y, Z)	-9 V to +14 V
Operating Temperature Range	-40°C to +85°C
Storage Temperature Range	-55°C to +150°C
ESD (HBM) on A, B, Y, and Z	± 8 kV

Stresses above those listed under Absolute Maximum Ratings may cause permanent damage to the device. This is a stress rating only; functional operation of the device at these or any other conditions above those indicated in the operational section of this specification is not implied. Exposure to absolute maximum rating conditions for extended periods may affect device reliability.

THERMAL RESISTANCE

θ_{JA} is specified for the worst-case conditions, that is, a device soldered in a circuit board for surface-mount packages.

Table 4. Thermal Resistance

Package Type	θ_{JA}	θ_{JC}	Unit
14-Lead SOIC	104.5	87.2	$^\circ\text{C}/\text{W}$
10-Lead MSOP	133		$^\circ\text{C}/\text{W}$

ESD CAUTION



ESD (electrostatic discharge) sensitive device. Charged devices and circuit boards can discharge without detection. Although this product features patented or proprietary protection circuitry, damage may occur on devices subjected to high energy ESD. Therefore, proper ESD precautions should be taken to avoid performance degradation or loss of functionality.

ADM1491E

PIN CONFIGURATIONS AND FUNCTION DESCRIPTIONS

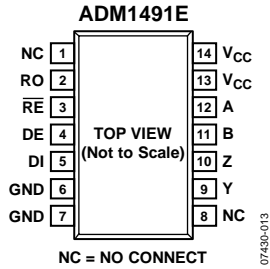

Figure 6. 14-Lead Narrow-Body SOIC Pin Configuration

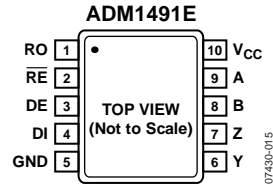

Figure 7. 10-Lead MSOP Pin Configuration

Table 5. Pin Function Descriptions

Pin No.		Mnemonic	Description
14-Lead SOIC	10-Lead MSOP		
1	N/A ¹	NC	No Connect. This pin is available on the 14-lead SOIC only.
2	1	RO	Receiver Output.
3	2	\overline{RE}	Receiver Output Enable. A low level enables the receiver output, whereas a high level places the receiver output in a high impedance state.
4	3	DE	Driver Output Enable. A high level enables the differential driver outputs, A and B, whereas a low places the differential driver outputs in a high impedance state.
5	4	DI	Driver Input. When the driver is enabled, a logic low on DI forces A low and B high, whereas logic high on DI forces A high and B low.
6	5	GND	Ground.
7	N/A ¹	GND	Ground. This pin is available on the 14-lead SOIC only.
8	N/A ¹	NC	No Connect. This pin is available on the 14-lead SOIC only.
9	6	Y	Noninverting Driver Output Y.
10	7	Z	Inverting Driver Output Z.
11	8	B	Inverting Receiver Input B.
12	9	A	Noninverting Receiver Input A.
13	10	V _{CC}	Power Supply (5 V ± 5%).
14	N/A ¹	V _{CC}	Power Supply (5 V ± 5%). This pin is available on the 14-lead SOIC only.

¹ N/A indicates not applicable to the MSOP.

TYPICAL PERFORMANCE CHARACTERISTICS

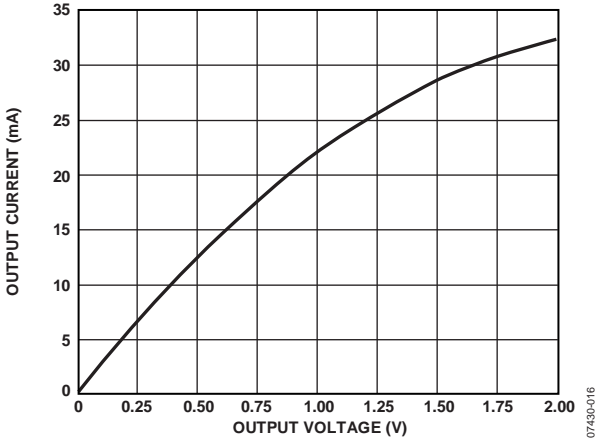

Figure 8. Output Current vs. Receiver Output Low Voltage

07430-016

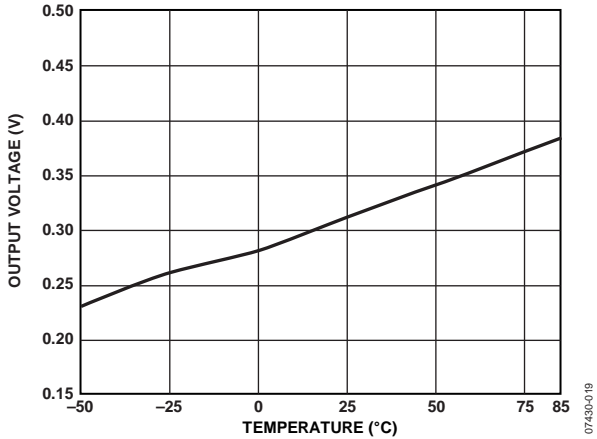

Figure 11. Receiver Output Low Voltage vs. Temperature ($I_{OUT} = 8\text{ mA}$)

07430-019

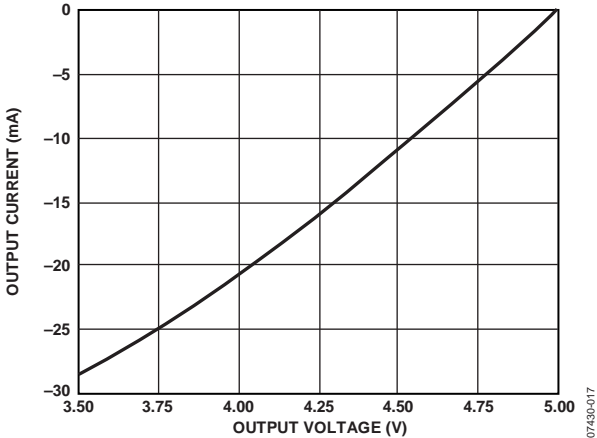

Figure 9. Output Current vs. Receiver Output High Voltage

07430-017

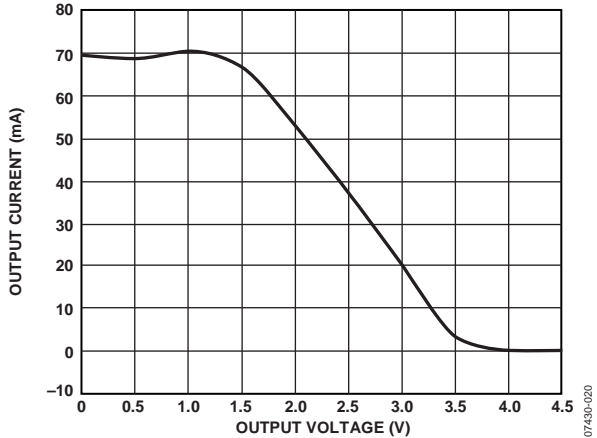

Figure 12. Output Current vs. Driver Differential Output Voltage

07430-020

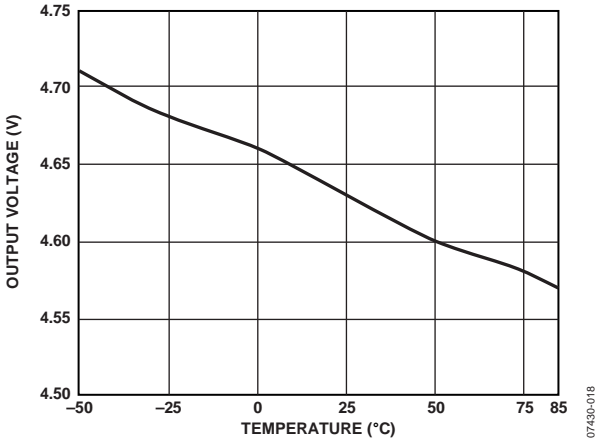

Figure 10. Receiver Output High Voltage vs. Temperature ($I_{OUT} = 8\text{ mA}$)

07430-018

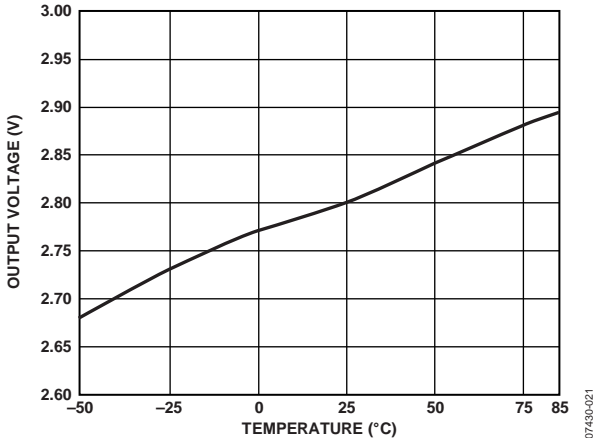

Figure 13. Driver Differential Output Voltage vs. Temperature ($R_L = 56.3\ \Omega$)

07430-021

ADM1491E

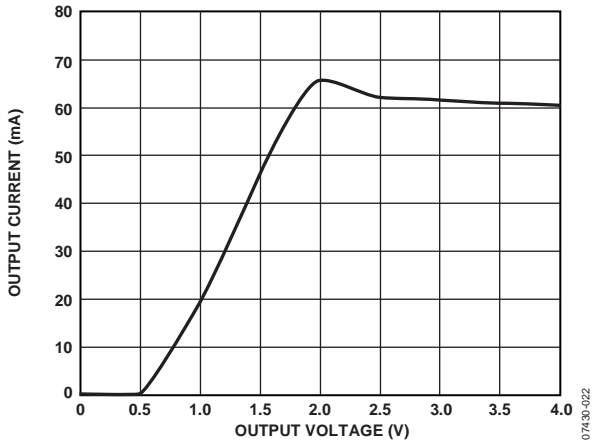

Figure 14. Output Current vs. Driver Output Low Voltage

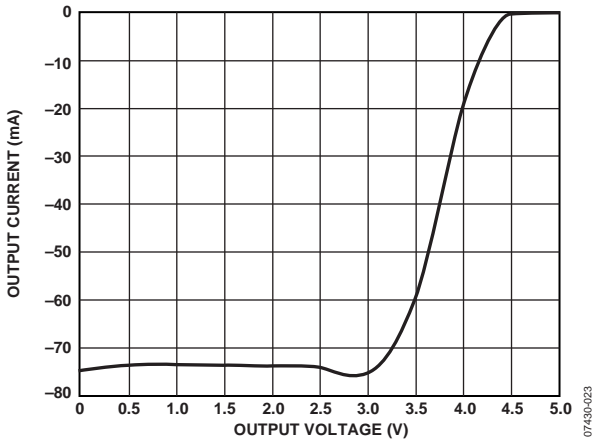

Figure 15. Output Current vs. Driver Output High Voltage

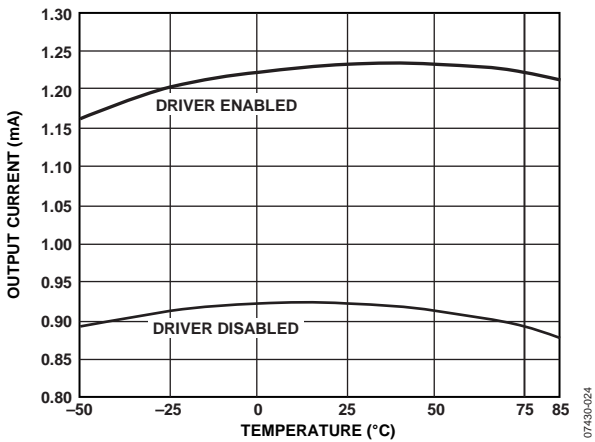

Figure 16. Output Current vs. Temperature

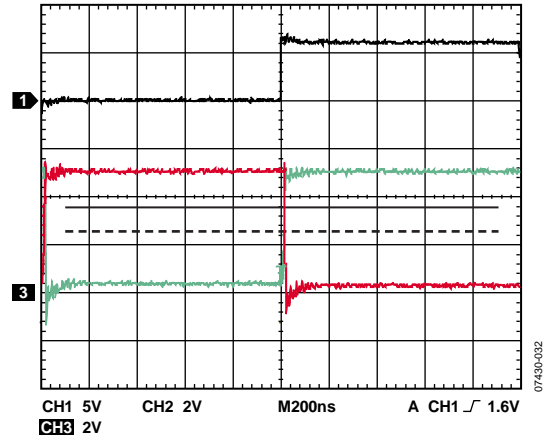

Figure 17. Unloaded Driver Differential Outputs

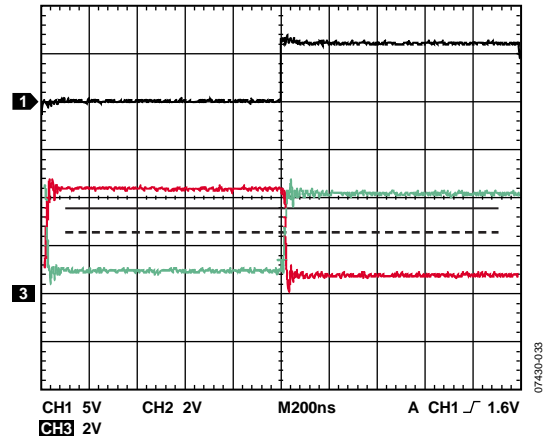

Figure 18. Loaded Driver Differential Outputs
($R_{\text{Differential}} = 54 \Omega$, $C_{L1} = C_{L2} = 100 \text{ pF}$)

TEST CIRCUITS

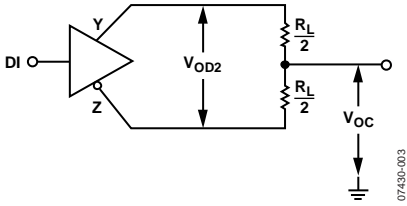

Figure 19. Driver Voltage Measurements

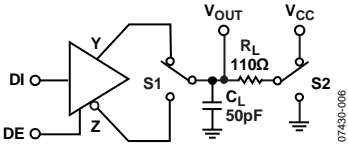

Figure 22. Driver Enable/Disable Timing

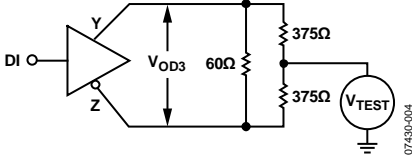

Figure 20. Driver Voltage Measurements

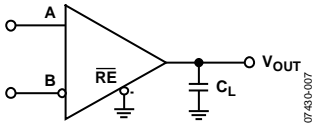

Figure 23. Receiver Propagation Delay

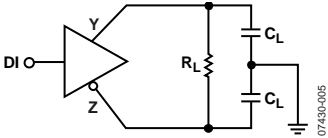

Figure 21. Driver Propagation Delay

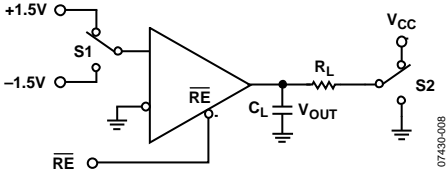

Figure 24. Receiver Enable/Disable Timing

THEORY OF OPERATION

The ADM1491E is an RS-485 transceiver that operates from a single 5 V \pm 5% power supply. The ADM1491E is intended for balanced data transmission and complies with both TIA/EIA-485-A and TIA/EIA-422-B. It contains a differential line driver and a differential line receiver and is suitable for full-duplex data transmission.

The input impedance of the ADM1491E is 12 k Ω , allowing up to 32 transceivers on the differential bus. A thermal shutdown circuit prevents excessive power dissipation caused by bus contention or by output shorting. This feature forces the driver output into a high impedance state if, during fault conditions, a significant temperature increase is detected in the internal driver circuitry.

The receiver contains a fail-safe feature that results in a logic high output state if the inputs are unconnected (floating).

The ADM1491E features very low propagation delay, ensuring maximum baud rate operation. The balanced driver ensures distortion free transmission.

Another important specification is a measure of the skew between the complementary outputs. Excessive skew impairs the noise immunity of the system and increases the amount of electromagnetic interference (EMI).

TRUTH TABLES

Table 6. Truth Table Abbreviations

Letter	Description
H	High level
I	Indeterminate
L	Low level
X	Irrelevant
Z	High impedance (off)

Table 7. Transmitting

Inputs		Outputs	
DE	DI	Z	Y
H	H	L	H
H	L	H	L
L	X	Z	Z

Table 8. Receiving

Inputs		Output
RE	A – B	RO
L	$\geq +0.2$ V	H
L	≤ -0.2 V	L
L	-0.2 V \leq A – B \leq +0.2 V	I
L	Inputs open	H
H	X	Z

ESD TRANSIENT PROTECTION SCHEME

The ADM1491E uses protective clamping structures on its inputs and outputs to clamp the voltage to a safe level and dissipate the energy present in ESD (electrostatic). The protection structure achieves ESD protection up to \pm 8 kV human body model (HBM).

ESD Testing

Two coupling methods are used for ESD testing: contact discharge and air gap discharge. Contact discharge calls for a direct connection to the unit being tested; air gap discharge uses a higher test voltage but does not make direct contact with the unit under test. With air discharge, the discharge gun is moved toward the unit under test, developing an arc across the air gap; hence the term air discharge. This method is influenced by humidity, temperature, barometric pressure, distance, and rate of closure of the discharge gun. The contact discharge method, though less realistic, is more repeatable and is gaining acceptance and preference over the air gap method.

Although very little energy is contained within an ESD pulse, the extremely fast rise time, coupled with high voltages, can cause failures in unprotected semiconductors. Catastrophic destruction can occur immediately because of arcing or heating. Even if catastrophic failure does not occur immediately, the device can suffer from parametric degradation, resulting in degraded performance. The cumulative effects of continuous exposure can eventually lead to complete failure.

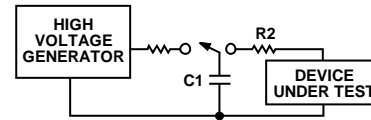

NOTES
1. THE ESD TEST METHOD USED IS THE HUMAN BODY MODEL (\pm 8kV) WITH R2 = 1500 Ω AND C1 = 100pF.

07430-025

Figure 25. ESD Generator

I/O lines are particularly vulnerable to ESD damage. Simply touching or plugging in an I/O cable can result in a static discharge that can damage or destroy the interface product connected to the I/O port. It is, therefore, extremely important to have high levels of ESD protection on the I/O lines.

The ESD discharge can induce latch-up in the device under test. Therefore, it is important to conduct ESD testing on the I/O pins while device power is applied. This type of testing is more representative of a real-world I/O discharge where the equipment is operating normally when the discharge occurs.

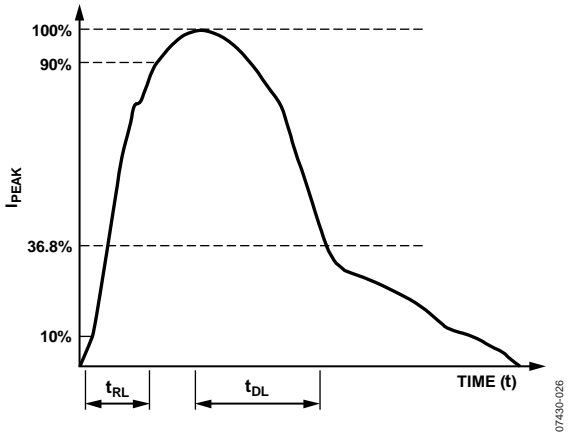

Figure 26. Human Body Model ESD Current Waveform

Table 9. ADM1491E ESD Test Results

ESD Test Method	Input/Output Pins	Other Pins
Human Body Model	±8 kV	±1.5 kV

APPLICATIONS INFORMATION

DIFFERENTIAL DATA

Differential data transmission reliably transmits data at high rates over long distances and through noisy environments. Differential transmission nullifies the effects of ground shifts and noise signals that appear as common-mode voltages on the line. There are two main standards approved by the Electronics Industries Association (EIA) that specify the electrical characteristics of transceivers used in differential data transmission.

The RS-422 standard specifies data rates of up to 10 MBaud and line lengths of up to 4000 feet. A single driver can drive a transmission line with as many as 10 receivers.

The RS-485 standard addresses true multipoint communications. This standard meets or exceeds all of the requirements of RS-422, and it allows as many as 32 drivers and 32 receivers to connect to a single bus. An extended common-mode range of -7 V to $+12\text{ V}$ is defined. The most significant difference between the RS-422 and the RS-485 is that the drivers with RS-485 can be disabled, allowing more than one driver to be connected to a single line; as many as 32 drivers can be connected to a single line. Only one driver should be enabled at a time, but the RS-485 standard contains additional specifications to guarantee device safety in the event of line contention.

CABLE AND DATA RATE

Twisted pair is the transmission line of choice for RS-485 communications. Twisted pair cable tends to cancel common-mode noise and causes cancellation of the magnetic fields generated by the current flowing through each wire, thereby reducing the effective inductance of the pair.

An RS-485 transmission line can have as many as 32 transceivers on the bus. Only one driver can transmit at a time, but multiple receivers may be enabled simultaneously.

As with any transmission line, it is important to minimize reflections. This can be achieved by terminating the extreme ends of the line using resistors equal to the characteristic impedance of the line. Keep stub lengths of the main line as short as possible. A properly terminated transmission line appears purely resistive to the driver.

TYPICAL APPLICATIONS

Figure 27 shows a typical configuration for a full-duplex multipoint application using the ADM1491E. To minimize reflections, the lines must be terminated at the receiving end in its characteristic impedance, and stub lengths off the main line must be kept as short as possible.

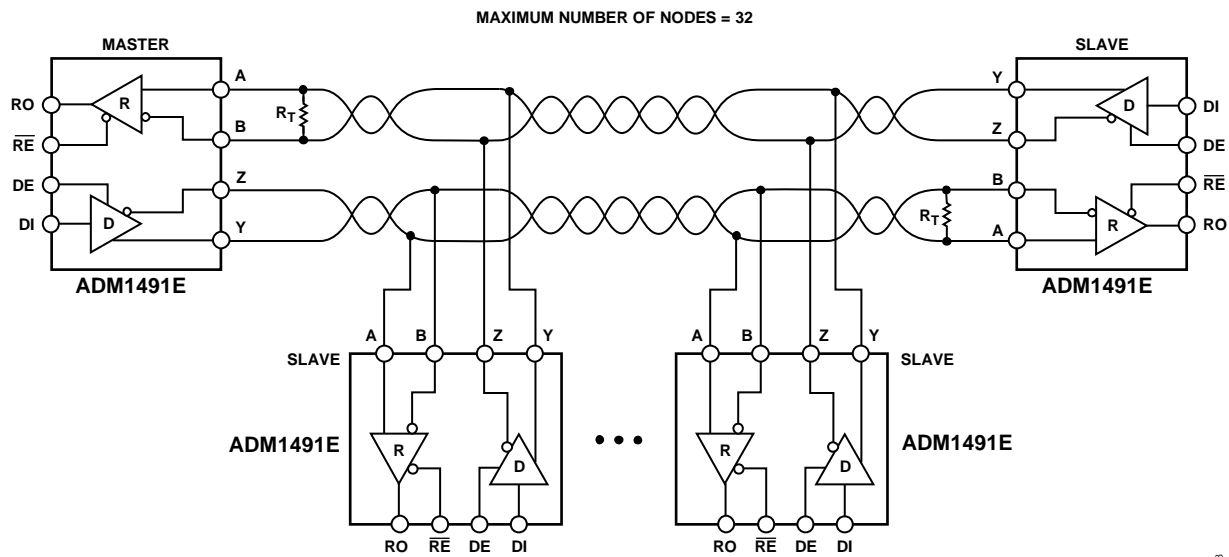

NOTES
1. R_T IS EQUAL TO THE CHARACTERISTIC IMPEDANCE OF THE CABLE.

Figure 27. Typical Application

07430-028

OUTLINE DIMENSIONS

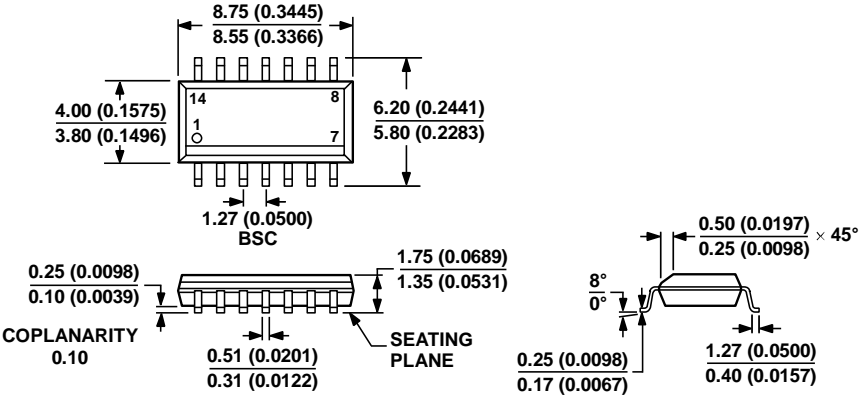

COMPLIANT TO JEDEC STANDARDS MS-012-AB
 CONTROLLING DIMENSIONS ARE IN MILLIMETERS; INCH DIMENSIONS
 (IN PARENTHESES) ARE ROUNDED-OFF MILLIMETER EQUIVALENTS FOR
 REFERENCE ONLY AND ARE NOT APPROPRIATE FOR USE IN DESIGN.

Figure 28. 14-Lead Standard Small Outline Package [SOIC_N]
 Narrow Body
 (R-14)

Dimensions shown in millimeters and (inches)

060606-A

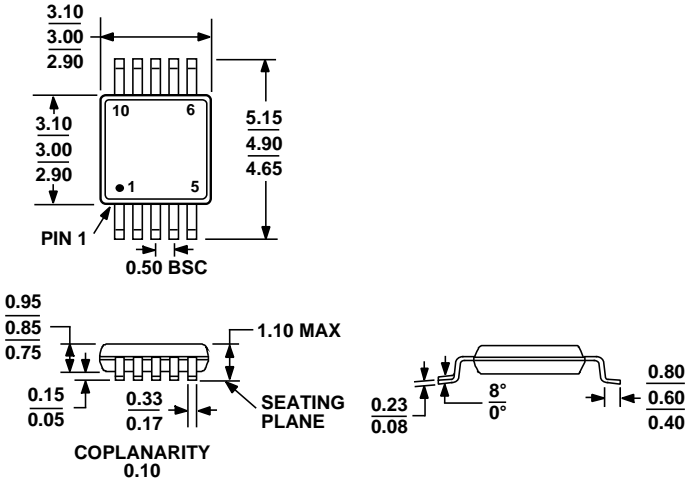

COMPLIANT TO JEDEC STANDARDS MO-187-BA

Figure 29. 10-Lead Mini Small Outline Package [MSOP]
 (RM-10)

Dimensions shown in millimeters

ORDERING GUIDE

Model	Temperature Range	Package Description	Package Option	Branding
ADM1491EBRZ ¹	-40°C to +85°C	14-Lead Standard Small Outline Package, Narrow Body [SOIC_N]	R-14	
ADM1491EBRZ-REEL7 ¹	-40°C to +85°C	14-Lead Standard Small Outline Package, Narrow Body [SOIC_N]	R-14	
ADM1491EBRMZ ¹	-40°C to +85°C	10-Lead Mini Small Outline Package [MSOP]	RM-10	FOD
ADM1491EBRMZ-REEL7 ¹	-40°C to +85°C	10-Lead Mini Small Outline Package [MSOP]	RM-10	FOD

¹ Z = RoHS Compliant Part.

ADM1491E

NOTES

NOTES

ADM1491E

NOTES