

RECYCLE WITH SEMICONDUCTOR

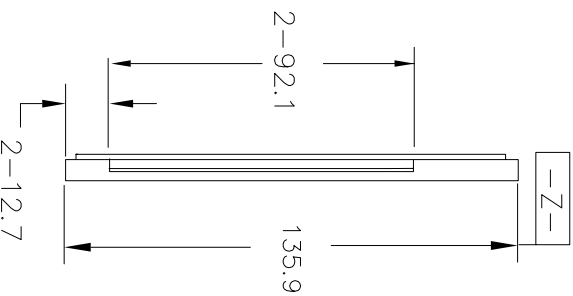
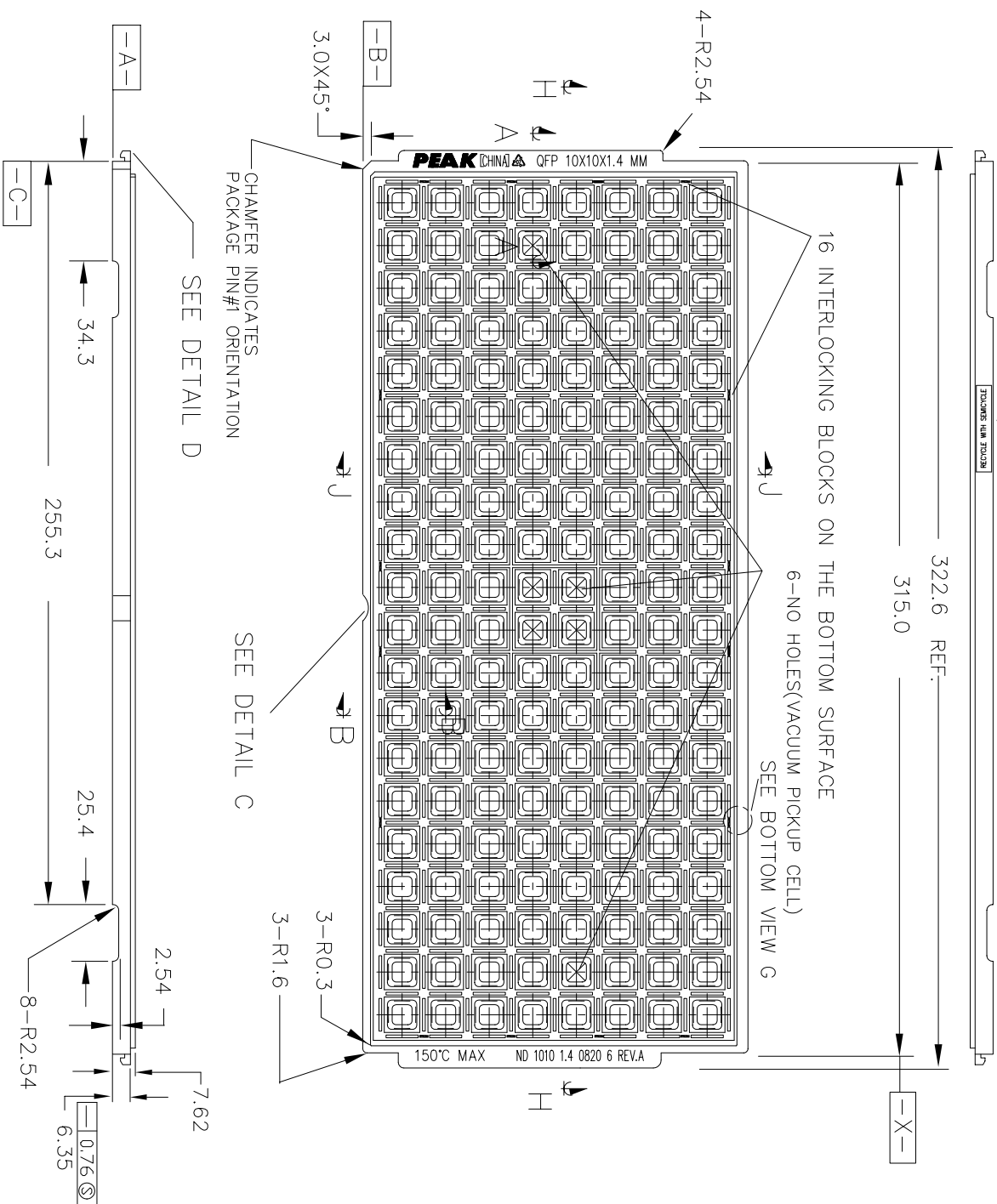

- NOTES :
1. MATERIAL - PP6.
  2. ALL DIMENSIONS ARE IN MILLIMETERS.
  3. TOLERANCES - X:XX=±0.25  
- XXX=±0.13
  4. ESD - SURFACE RESISTIVITY  
- 10<sup>5</sup> TO 10<sup>11</sup> OHMS/SQ.
  5. FOR PACKAGE - 1.4MM THICKNESS.
  6. PART NO. : ND 1010 1.4 0820 6 REV.A (PLEASE INDICATE ON PURCHASE ORDER).
  7. ESD - SURFACE RESISTIVITY 10<sup>11</sup> OHMS/SQ MAX. (APPLICABLE FOR ASE PARTS ONLY)

18	P-00953	CHANGE FROM TOPP TO QFP	10 AUG 99
17	P-00897	CHANGE SURFACE RESISTIVITY	2 FEB 99
16	P-00651	CANCEL COLOR REQUIREMENT	16 OCT 97
15	P-00536	ADD DETAIL S AS MARKING	15 SEP 95
14	P-00546	DELETED "ASSEMBLED IN SINGAPORE"	1 SEP 95
13	P-00461	CHANGE "LOW TEMP." TO "75°C MAX."	11 JAN 95
REVNO.	ECN #	DESCRIPTION	DATE

THIS DOCUMENT CONTAINS INFORMATION PROPRIETARY TO PEAK PLASTIC & METAL PRODUCTS INTERNATIONAL LIMITED. REPRODUCTION DISCLOSE OR USE OF THIS DOCUMENT IS EXPRESSLY PROHIBITED EXCEPT OTHERWISE AGREED UPON IN WRITING.

DRAWN BY :	BUSH	PAGE 1 OF 2
CHECKED BY :		DATE : 10 AUG 99
APPROVED BY :		DATE : 10 AUG 99
APPROVED BY :		DATE : 10 AUG 99
DO NOT SCALE DRAWING		CODE : CSA00556

CUSTOMER : **PEAK** PEAK PLASTIC & METAL PRODUCTS INT'L LTD.

TITLE : ND 1010 1.4 0820 6 REV.A  
 DWG NO. : ND 1010 1.4 0820 6 REV.A  
 REV. 18

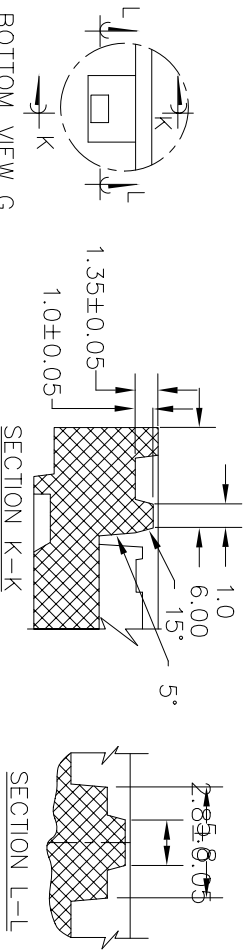
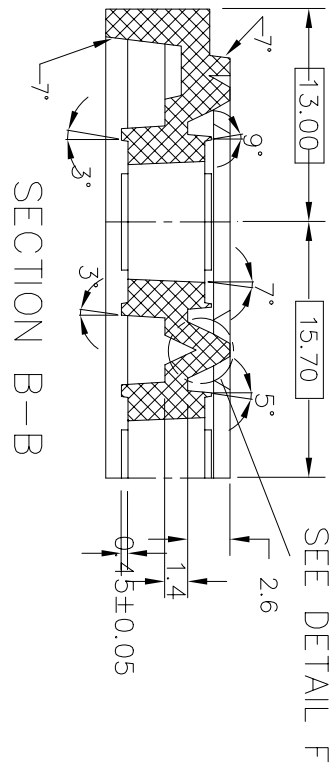
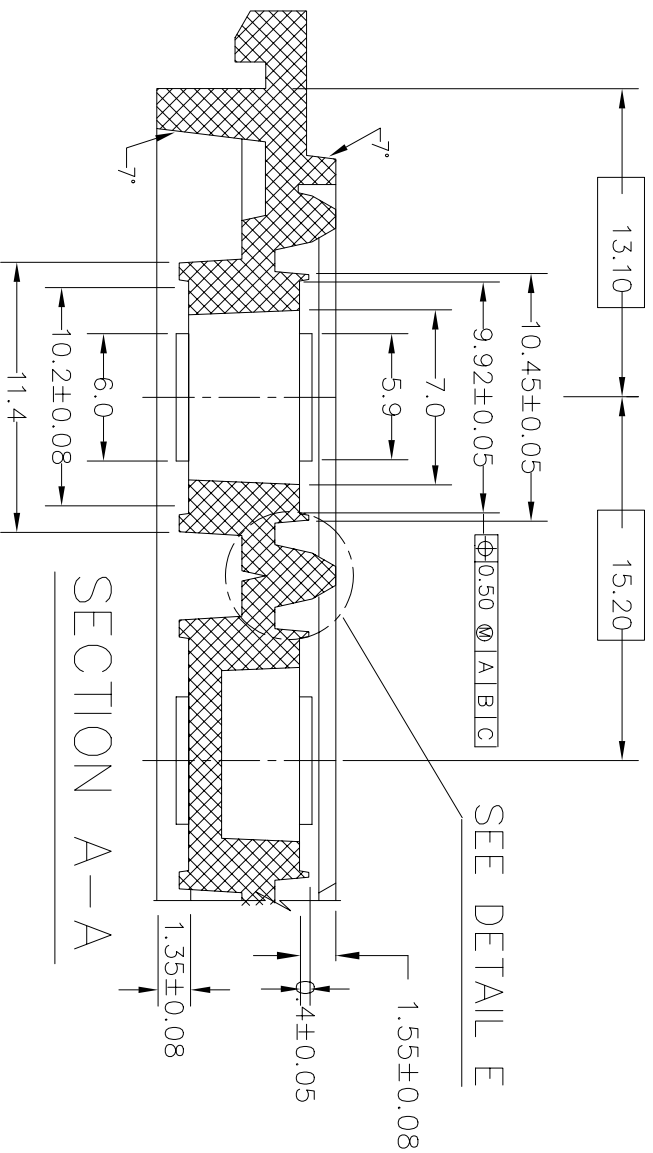

BOTTOM VIEW G

18	P-00953	CHANGE FROM TOPF TO GFP	10 AUG 99
17	P-00897	CHANGE SURFACE RESISTIVITY	2 FEB 99
16	P-00651	CANCEL COLOR REQUIREMENT	16 OCT 97
15	P-00556	ADD DETAIL S AS MARKING	15 SEP 95
14	P-00546	DELETED "ASSEMBLED IN SINGAPORE"	1 SEP 95
13	P-00461	CHANGE "LOW TEMP." TO "75C MAX."	11 JAN 95
REVNO.	ECN #	DESCRIPTION	DATE

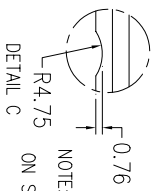
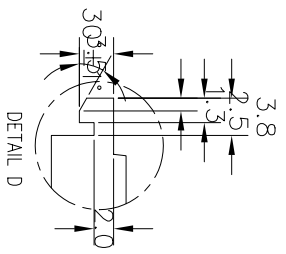
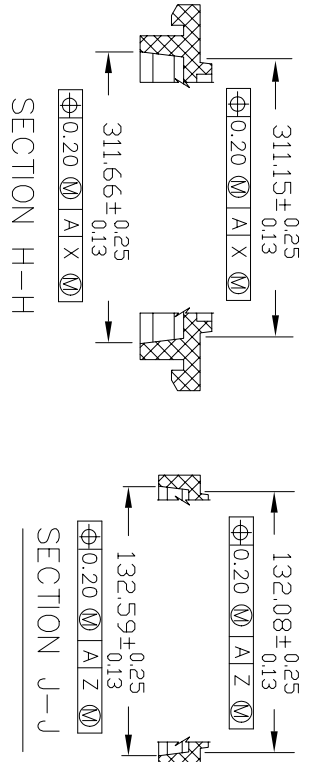
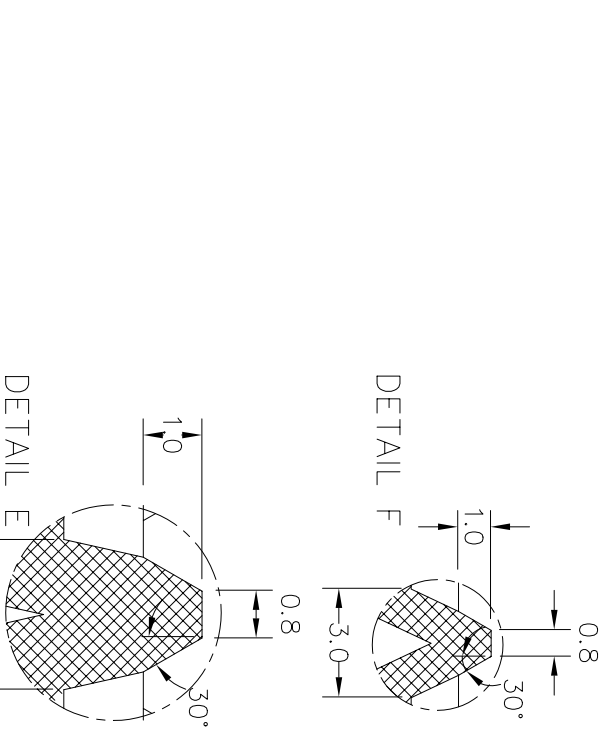

THIS DOCUMENT CONTAINS INFORMATION PROPRIETARY TO PEAK PLASTIC & METAL PRODUCTS INTERNATIONAL. LIMITED REPRODUCTION DISCLOSURE OR USE OF THIS DOCUMENT IS EXPRESSLY PROHIBITED EXCEPT OTHERWISE AGREED UPON IN WRITING.

DRAWN BY :	BUSH	PAGE 2 OF 2
CHECKED BY :		DATE : 10 AUG 99
APPROVED BY :		DATE : 10 AUG 99
APPROVED BY :		DATE : 10 AUG 99
DO NOT SCALE DRAWING		CODE : CSA00556

CUSTOMER : **PEAK**  
 PEAK PLASTIC & METAL PRODUCTS INT'L LTD.  
 TITLE : ND 1010 1.4 0820 6 REV.A  
 DWG NO. : ND 1010 1.4 0820 6 REV.A  
 REV. 18