

MEW1000 Series

2W, Wide Input Range SIP, Single & Dual Output DC/DC Converters



Key Features



- Efficiency up to 80%
- 1500VDC Isolation
- MTBF > 1,000,000 Hours
- 4:1 Wide Input Range
- Low Cost
- Remote On/Off Control
- Low Ripple and Noise
- Temperature Performance -40°C to $+75^{\circ}\text{C}$
- UL 94V-0 Package Material
- Internal SMD Construction

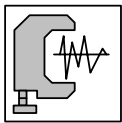

Low Noise

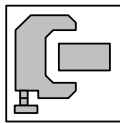

Low Profile

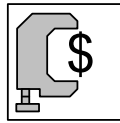

Low Cost

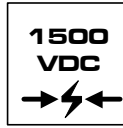

I/O Isolation

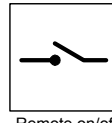

Remote on/off

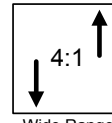

Wide Range

Minmax's MEW1000-Series power modules are low-profile dc-dc converters that operate over input voltage ranges of 9–36VDC and 18–75VDC which provide precisely regulated output voltages of 3.3V, 5V, 12V, 15V, $\pm 5\text{V}$, $\pm 12\text{V}$ and $\pm 15\text{VDC}$.

The MEW1000 series is an excellent selection for data communication equipments, mobile battery driven equipments, distributed power systems, telecommunication equipments, mixed analog/digital subsystems, process/machine control equipments, computer peripheral systems and industrial robot systems.

The modules have a maximum power rating of 2W and a typical full-load efficiency of 80%, continuous short circuit, 30mV output ripple, built-in filtering for both input and output minimize the need for external filtering.

Absolute Maximum Ratings

Parameter		Min.	Max.	Unit
Input Surge Voltage (1000 mS)	24VDC Input Models	-0.7	50	VDC
	48VDC Input Models	-0.7	100	VDC
Lead Temperature (1.5mm from case for 10 Sec.)		---	260	$^{\circ}\text{C}$
Internal Power Dissipation		---	2,500	mW

Exceeding the absolute maximum ratings of the unit could cause damage. These are not continuous operating ratings.

Environmental Specifications

Parameter	Conditions	Min.	Max.	Unit
Operating Temperature	Ambient	-40	+75	$^{\circ}\text{C}$
Operating Temperature	Case	-40	+90	$^{\circ}\text{C}$
Storage Temperature		-55	+105	$^{\circ}\text{C}$
Humidity		---	95	%
Cooling	Free-Air Convection			

Model Selection Guide

Model Number	Input Voltage	Output Voltage	Output Current		Input Current		Reflected Ripple Current	Efficiency
			Max.	Min.	@Max. Load	@No Load		@Max. Load
	VDC	VDC	mA	mA	mA (Typ.)	mA (Typ.)	mA (Typ.)	% (Typ.)
MEW1021	24 (9 ~ 36)	3.3	500	125	97	20	300	71
MEW1022		5	400	100	110			76
MEW1023		12	167	42	106			79
MEW1024		15	134	33	105			80
MEW1025		±5	±200	±50	114			73
MEW1026		±12	±83	±21	108			77
MEW1027		±15	±67	±17	106			79
MEW1031	48 (18 ~ 75)	3.3	500	125	49	15	600	70
MEW1032		5	400	100	58			72
MEW1033		12	167	42	54			78
MEW1034		15	134	33	54			78
MEW1035		±5	±200	±50	60			70
MEW1036		±12	±83	±21	55			76
MEW1037		±15	±67	±17	55			76

Capacitive Load

Models by Vout	3.3V	5V	12V	15V	±5V #	±12V #	±15V #	Unit
Maximum Capacitive Load	2200	1000	170	110	470	100	47	uF

For each output

Input Fuse Selection Guide

24V Input Models	48V Input Models
350mA Slow – Blow Type	135mA Slow – Blow Type

Input Specifications

Parameter	Model	Min.	Typ.	Max.	Unit
Start Voltage	24V Input Models	4.5	6	8.5	VDC
	48V Input Models	8.5	12	17	
Under Voltage Shutdown	24V Input Models	---	---	8	VDC
	48V Input Models	---	---	16	
Reverse Polarity Input Current	All Models	---	---	0.5	A
Short Circuit Input Power		---	---	1500	mW
Input Filter		Capacitor type			

MEW1000 Series

Output Specifications

Parameter	Conditions	Min.	Typ.	Max.	Unit
Output Voltage Accuracy		---	±1.0	±2.0	%
Output Voltage Balance	Dual Output, Balanced Loads	---	±1.0	±2.0	%
Line Regulation	Vin=Min. to Max.	---	±0.3	±0.5	%
Load Regulation	Io=25% to 100%	---	±0.5	±0.75	%
Ripple & Noise (20MHz)		---	30	50	mV P-P
Ripple & Noise (20MHz)	Over Line, Load & Temp.	---	---	75	mV P-P
Ripple & Noise (20MHz)		---	---	15	mV rms
Over Power Protection		120	---	---	%
Transient Recovery Time	25% Load Step Change	---	100	300	uS
Transient Response Deviation		---	±3	±5	%
Temperature Coefficient		---	±0.01	±0.02	%/°C
Output Short Circuit	Continuous				

General Specifications

Parameter	Conditions	Min.	Typ.	Max.	Unit
Isolation Voltage Rated	60 Seconds	1500	---	---	VDC
Isolation Voltage Test	Flash Tested for 1 Second	1650	---	---	VDC
Isolation Resistance	500VDC	1000	---	---	MΩ
Isolation Capacitance	100KHz, 1V	---	250	500	pF
Switching Frequency		---	300	---	KHz
MTBF	MIL-HDBK-217F @ 25°C, Ground Benign	1000	---	---	K Hours

Remote On/Off Control

Parameter	Conditions	Min.	Typ.	Max.	Unit
Supply On	Under 0.6 VDC or Open Circuit, drops down to 0VDC by 2mV/°C				
Supply Off		2.9	---	15	VDC
Device Standby Input Current		---	1	3	mA
Control Input Current (on)	Vin = 0V	---	---	-1	mA
Control Input Current (off)	Vin = 5.0V	---	---	1	mA
Control Common	Referenced to Negative Input				

Notes:

1. Specifications typical at Ta=+25°C, resistive load, nominal input voltage, rated output current unless otherwise noted.
2. Transient recovery time is measured to within 1% error band for a step change in output load of 75% to 100%.
3. Ripple & Noise measurement bandwidth is 0-20 MHz.
4. These power converters require a minimum output loading to maintain specified regulation.
5. Operation under no-load conditions will not damage these modules; however, they may not meet all specifications listed.
6. All DC/DC converters should be externally fused on the front end for protection.
7. Other input and output voltage may be available, please contact factory.
8. Specifications subject to change without notice.

Block Diagram

Single Output

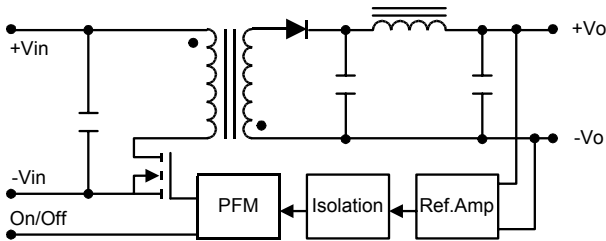

Dual Output

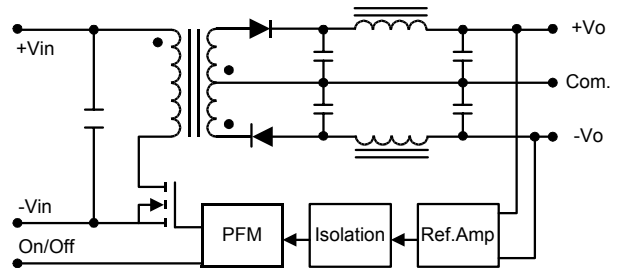

Input Voltage Transient Rating

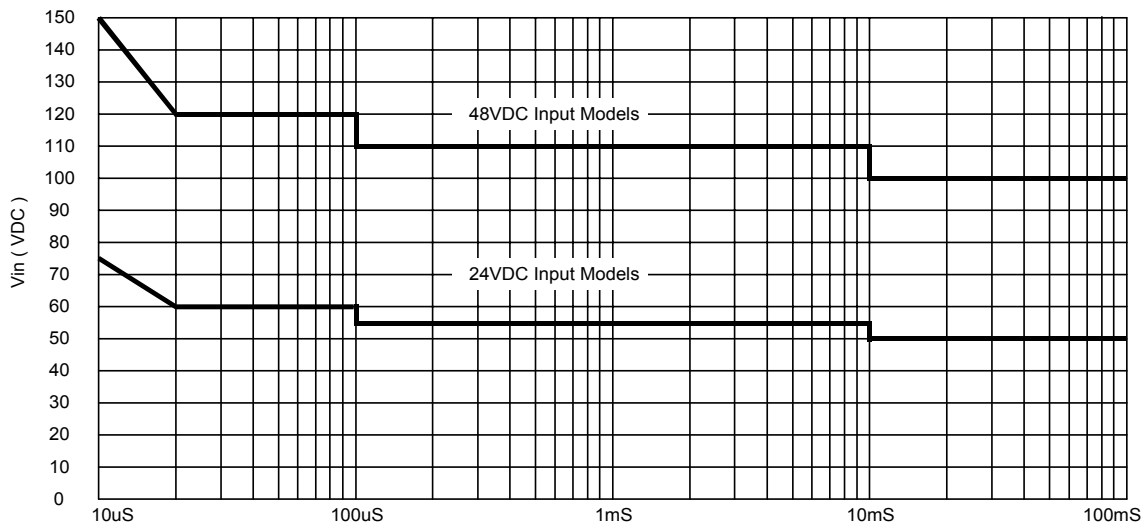

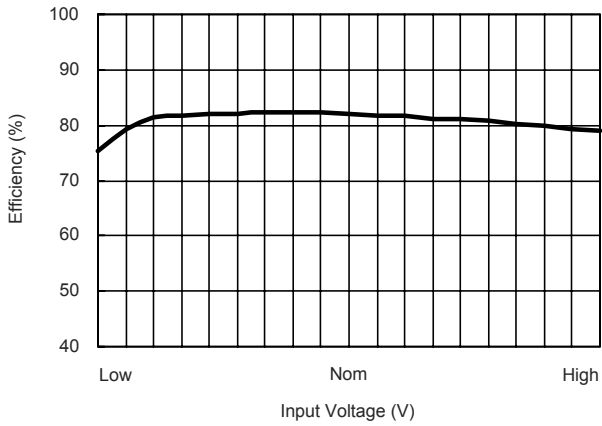

Efficiency vs Input Voltage (Single Output)

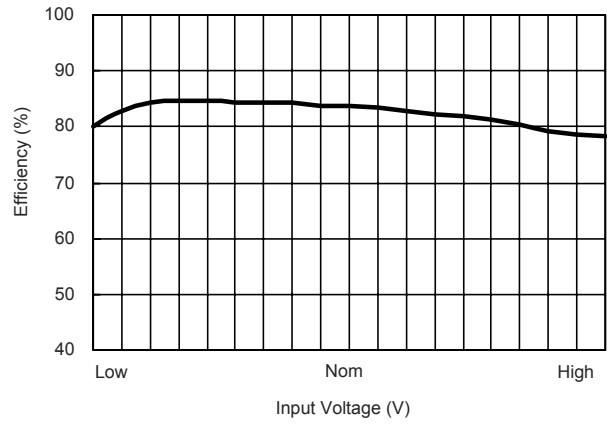

Efficiency vs Input Voltage (Dual Output)

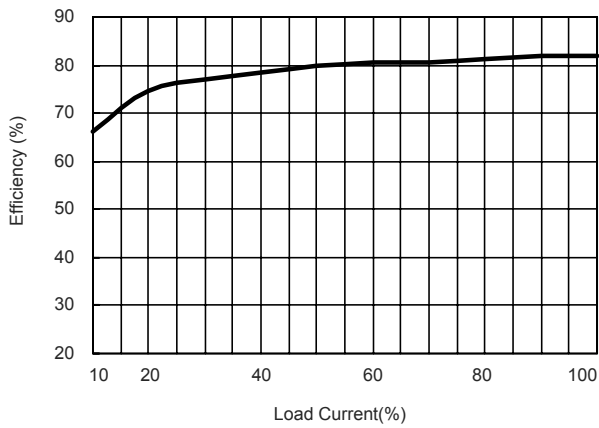

Efficiency vs Output Load (Single Output)

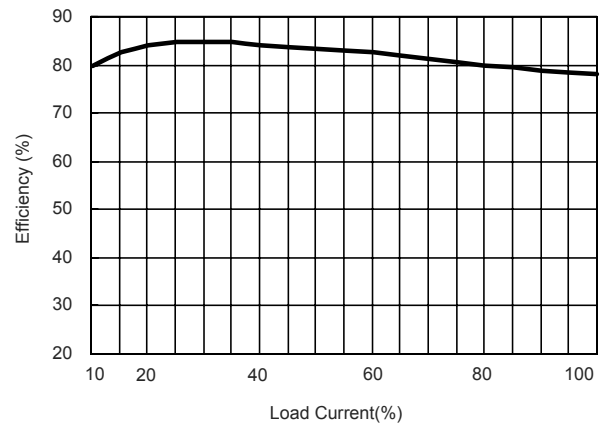

Efficiency vs Output Load (Dual Output)

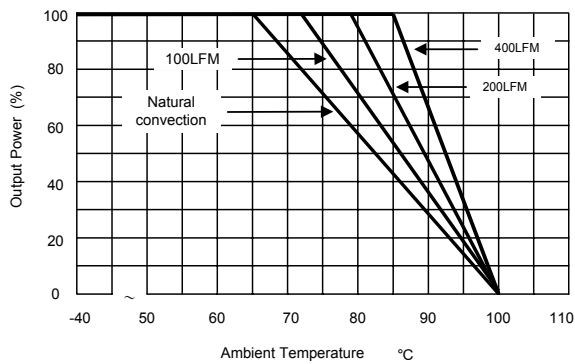

Derating Curve

Test Configurations

Input Reflected-Ripple Current Test Setup

Input reflected-ripple current is measured with an inductor L_{in} (4.7 μ H) and C_{in} (220 μ F, ESR < 1.0 Ω at 100 kHz) to simulated source impedance.

Capacitor C_{in} , offsets possible battery impedance.

Current ripple is measured at the input terminals of the module, measurement bandwidth is 0–500KHz.

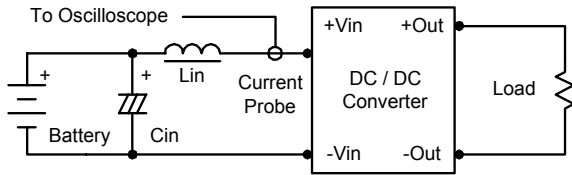

Peak-to-Peak Output Noise Measurement Test

Use a C_{out} 0.47 μ F ceramic capacitor.

Scope measurement should be made by using a BNC socket, measurement bandwidth is 0–20 MHz. Position the load between 50 mm and 75 mm from the DC/DC Converter.

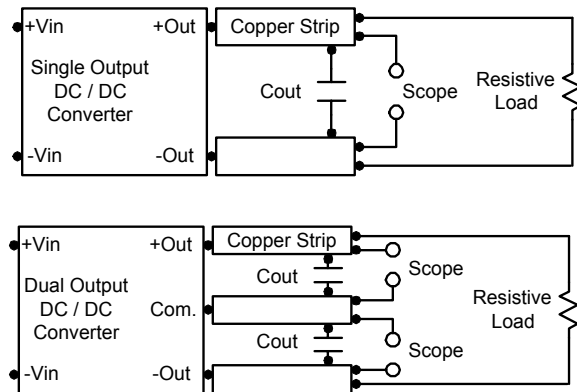

Design & Feature Considerations

Remote On/Off

Negative logic remote on/off turns the module off during a logic high voltage on the remote on/off pin, and on during a logic low.

To turn the power module on and off, the user must supply a switch to control the voltage between the on/off terminal and the $-V_{in}$ terminal.

The switch can be an open collector or equivalent.

A logic high is 2.9V to 15V.

A logic low is under 0.6 VDC or open circuit, drops down to 0VDC by 2mV/°C

The maximum sink current at on/off terminal during a logic low is 1 mA.

The maximum allowable leakage current of the switch at on/off terminal =(under 0.6VDC or open circuit) is 1mA.

Maximum Capacitive Load

The MEW1000 series has limitation of maximum connected capacitance on the output.

The power module may operate in current limiting mode during start-up, affecting the ramp-up and the startup time.

The maximum capacitance can be found in the data sheet.

Overcurrent Protection

To provide protection in a fault (output overload) condition, the unit is equipped with internal current limiting circuitry and can endure current limiting for an unlimited duration. At the point of current-limit inception, the unit shifts from voltage control to current control. The unit operates normally once the output current is brought back into its specified range.

Input Source Impedance

The power module should be connected to a low ac-impedance input source. Highly inductive source impedances can affect the stability of the power module.

In applications where power is supplied over long lines and output loading is high, it may be necessary to use a capacitor on the input to insure startup.

By using a good quality low Equivalent Series Resistance (ESR < 1.0 Ω at 100 kHz) capacitor of a 1.5 μ F for the 24V and 48V devices, capacitor mounted close to the power module helps ensure stability of the unit.

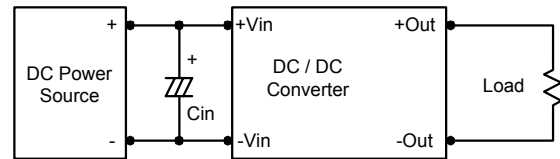

Output Ripple Reduction

A good quality low ESR capacitor placed as close as practicable across the load will give the best ripple and noise performance.

To reduce output ripple, it is recommended that 3.3 μ F capacitors are used on output.

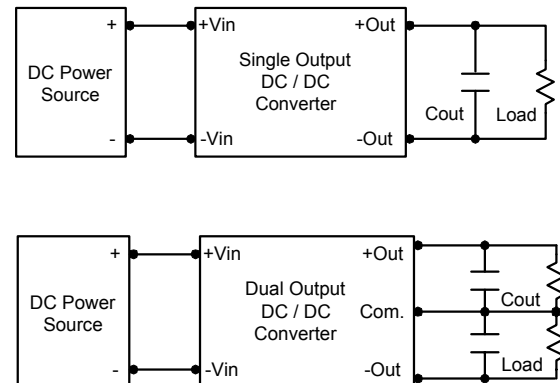

Thermal Considerations

Many conditions affect the thermal performance of the power module, such as orientation, airflow over the module, and board spacing. To avoid exceeding the maximum temperature rating of the components inside the power module, the case temperature must be kept below 90°C.

The derating curves were determined from measurements obtained in an experimental apparatus.

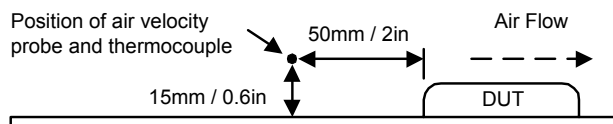

Mechanical Dimensions

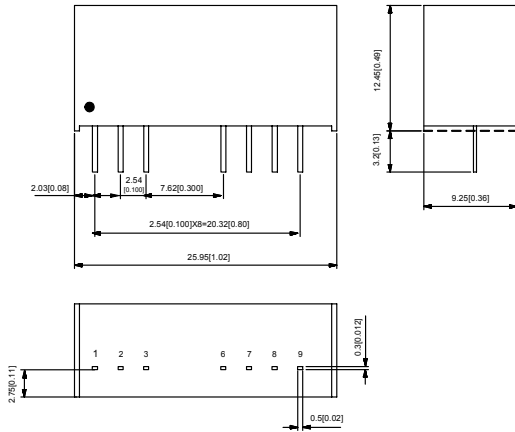

Physical Characteristics

- Case Size** : 25.95x9.25x12.45 mm
: 1.02x0.36x0.49 inches
- Case Material** : Non-Conductive Black Plastic
- Weight** : 6.5g
- Flammability** : UL94V-0

Tolerance	Millimeters	Inches
	X.X±0.25	X.XX±0.01
	X.XX±0.13	X.XXX±0.005
Pin	±0.05	±0.002

Pin Connections

Pin	Single Output	Dual Output
1	-Vin	-Vin
2	+Vin	+Vin
3	Remote On/Off	Remote On/Off
6	+Vout	+Vout
7	NC	Common
8	NC	NC
9	-Vout	-Vout

NC: No Connection