

RoHS Compliant Product
A suffix of "-C" specifies halogen & lead-free

FEATURES

- Low Turn-on Voltage
- Low Forward Voltage
- Very Low Capacitance
Less Than 5.0pF @ 0V
- For high speed switching application, circuit protection

MECHANICAL DATA

- Case: SOT-323, Molded Plastic
- Terminals: Solderable per MIL-STD-202, Method 208
- Polarity: See Diagrams Below
- Weight: 0.006 grams (approx.)
- Mounting Position: Any

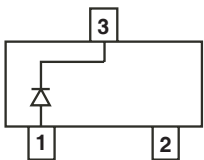
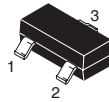
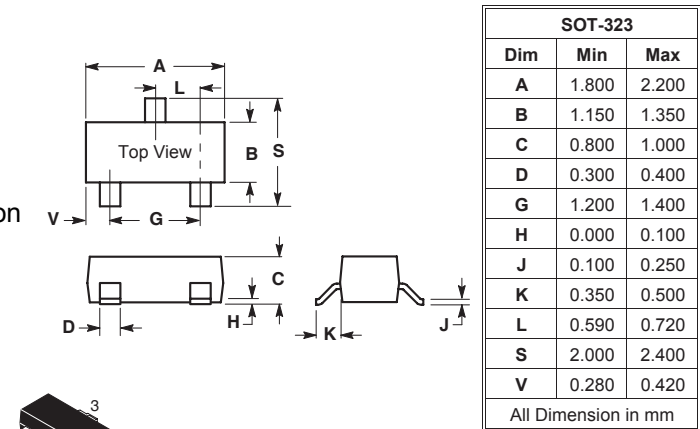

BAS40W Marking: 43

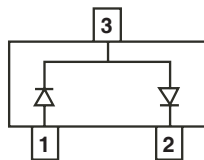

BAS40-04W Marking: 44

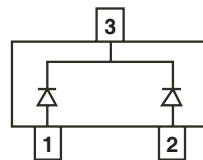

BAS40-05W Marking: 45

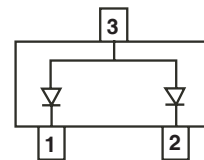

BAS40-06W Marking: 46

ABSOLUTE MAXIMUM RATINGS at Ta = 25°C

Parameter	Symbol	Ratings	Unit
Reverse Voltage	V_R	40	V
Forward Continuous Current	I_F	200	mA
Single Forward Current, $t \leq 10$ ms	I_{FSM}	600	mA
Thermal Resistance (Note 1) Junction-to-Ambient (Note 2)	$R_{\theta JA}$	508 311	°C/W
Forward Power Dissipation @ $T_A = 25^\circ\text{C}$ Derate above 25°C	P_F	325 1.8	mW mW / °C
Junction, Storage Temperature	T_J, T_{STG}	-55 ~ +150	°C

ELECTRICAL CHARACTERISTICS (at Ta = 25°C unless otherwise specified)

Parameters	Symbol	Min.	Max.	Unit	Test Conditions
Reverse Breakdown Voltage	$V_{(BR)R}$	40	-	V	$I_R = 10 \mu\text{A}$
Reverse Current	I_R	-	200	nA	$V_R = 30\text{V}$
Forward Voltage	V_{F1}	-	380	mV	$I_F = 1\text{mA}$
	V_{F2}	-	1000	mV	$I_F = 40\text{mA}$
Diode Capacitance	C_{TOT}	-	5.0	pF	$V_R = 0, f=1\text{MHz}$
Reverse Recovery Time	t_{RR}	-	5	nS	$I_{RR} = 1 \text{ mA}, I_R=I_F=10\text{mA}, R_L=100\Omega$

RATINGS AND CHARACTERISTIC CURVES

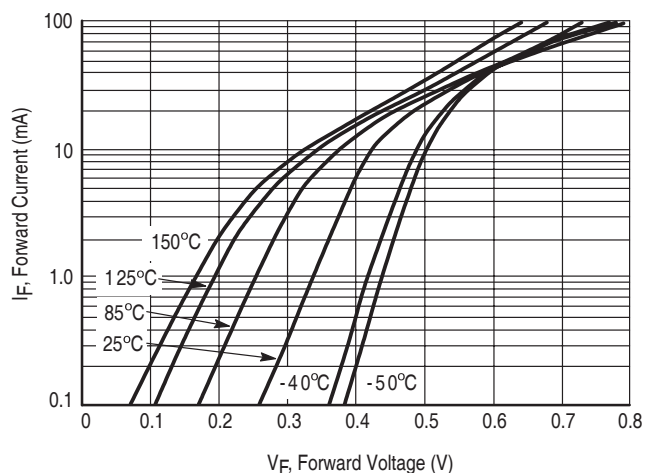

Figure 1. Typical Forward Voltage

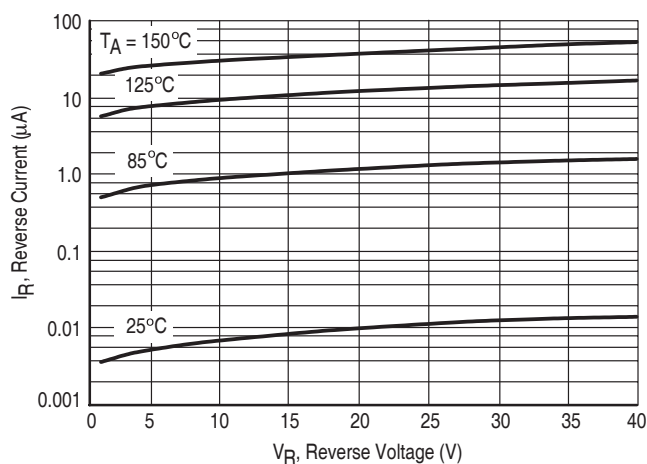

Figure 2. Reverse Current versus Reverse Voltage

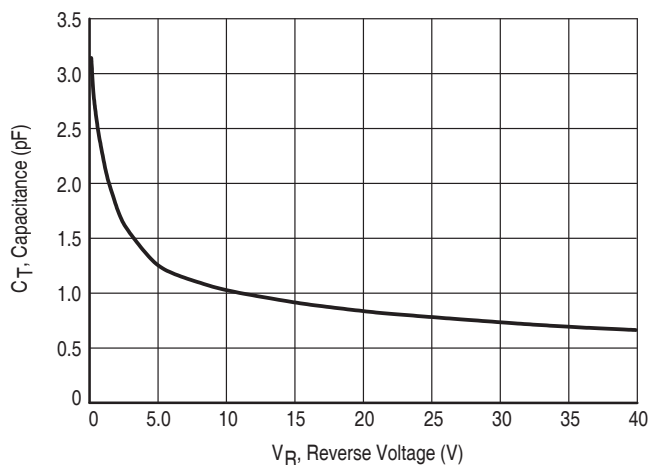

Figure 3. Typical Capacitance