

Silicon NPN Power Transistors

2SC3638

DESCRIPTION

- With TO-3PN package
- High voltage ,high speed
- High reliability

APPLICATIONS

- Ultrahigh-definition CRT display horizontal deflection output applications

PINNING

PIN	DESCRIPTION
1	Base
2	Collector;connected to mounting base
3	Emitter

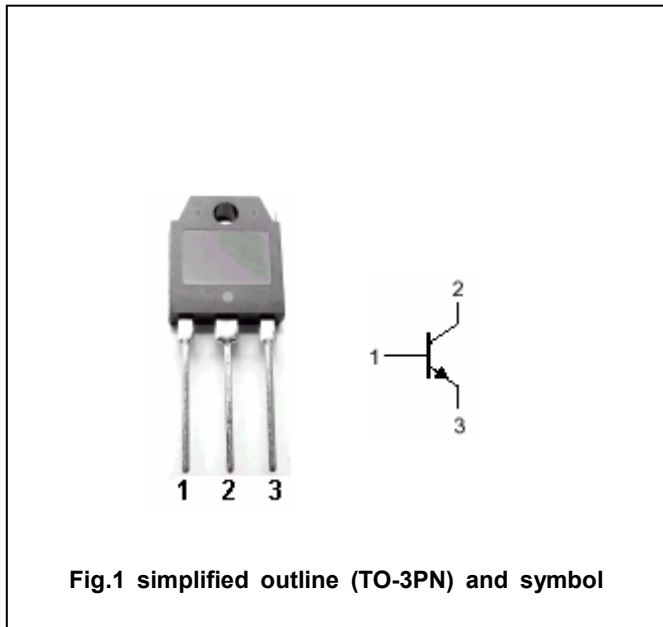

Fig.1 simplified outline (TO-3PN) and symbol

Absolute maximum ratings(Ta=□)

SYMBOL	PARAMETER	CONDITIONS	VALUE	UNIT
V _{CBO}	Collector-base voltage	Open emitter	900	V
V _{CEO}	Collector-emitter voltage	Open base	500	V
V _{EBO}	Emitter-base voltage	Open collector	7	V
I _C	Collector current		15	A
I _{CM}	Collector current-peak		25	A
P _C	Collector power dissipation	T _C =25□	100	W
T _j	Junction temperature		150	□
T _{stg}	Storage temperature		-55~150	□

Silicon NPN Power Transistors

2SC3638

CHARACTERISTICS

T_j=25 °C unless otherwise specified

SYMBOL	PARAMETER	CONDITIONS	MIN	TYP.	MAX	UNIT
V _{CE0(SUS)}	Collector-emitter sustaining voltage	I _C =100mA ; I _B =0	500			V
V _{CEsat}	Collector-emitter saturation voltage	I _C =7A ; I _B =1.4A			2.0	V
V _{BEsat}	Base-emitter saturation voltage	I _C =7A ; I _B =1.4A			1.5	V
I _{CBO}	Collector cut-off current	V _{CB} =500V ; I _E =0			10	μA
I _{CES}	Collector cut-off current	V _{CE} =900V ; R _{BE} =0			0.5	mA
I _{EBO}	Emitter cut-off current	V _{EB} =5V ; I _C =0			1.0	mA
h _{FE}	DC current gain	I _C =1.4A ; V _{CE} =5V	8			

Switching times

t _s	Storage time	V _{CC} =200V ; I _C =7A ; I _{B1} =1.4A ; I _{B2} =-2.8A			3.0	μs
t _f	Fall time			0.1	0.2	μs

Silicon NPN Power Transistors

2SC3638

PACKAGE OUTLINE

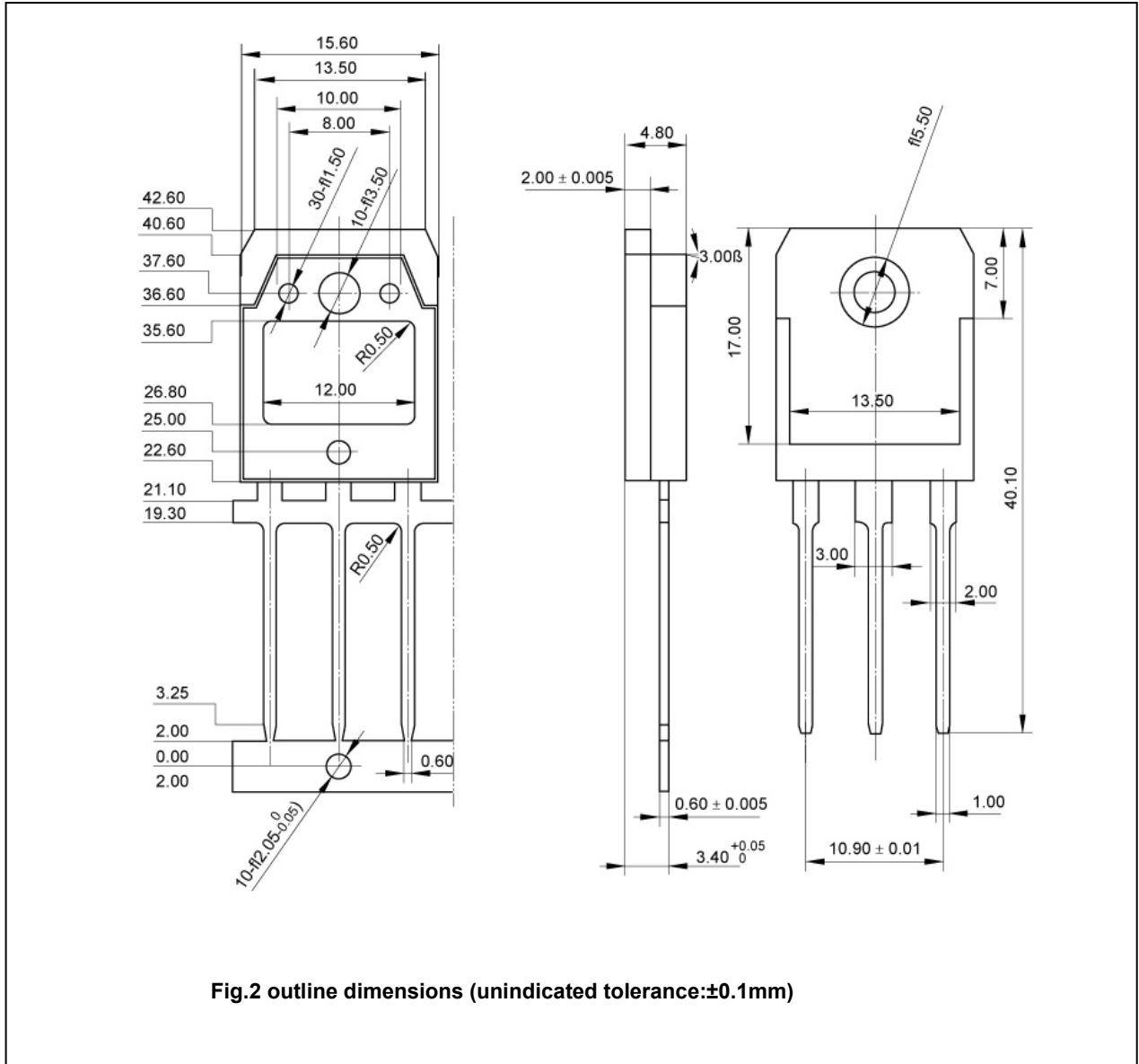

Silicon NPN Power Transistors

2SC3638

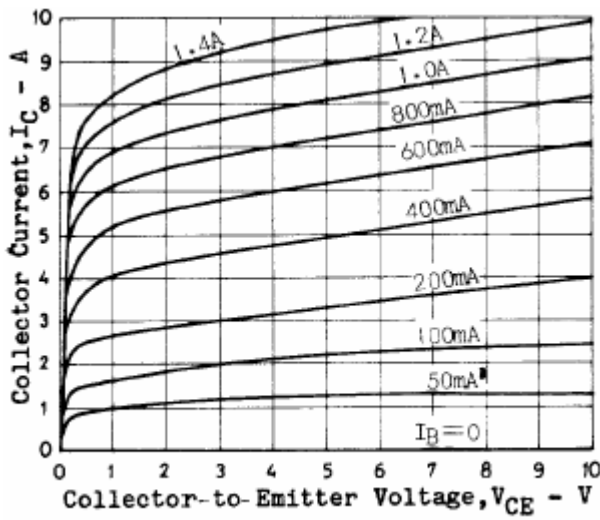

Fig.3 Static Characteristic

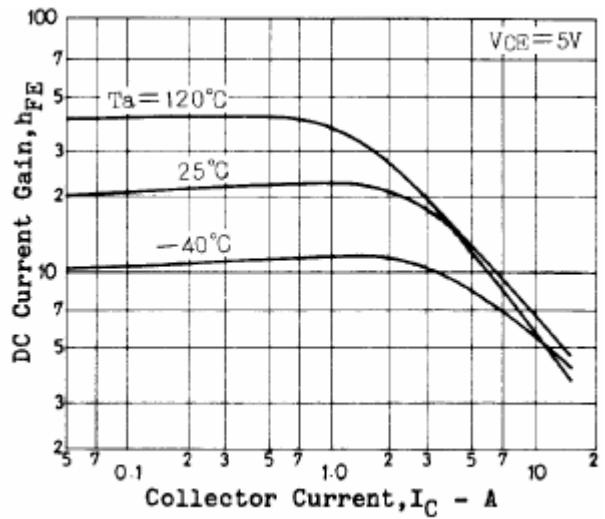

Fig.4 DC current Gain

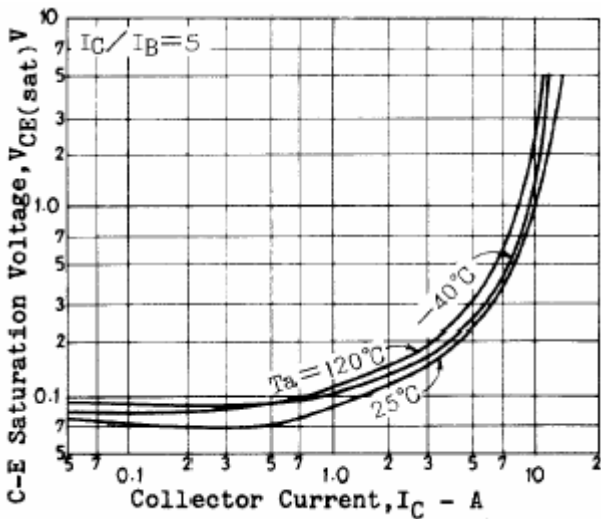

Fig.5 Collector-Emitter Saturation Voltage

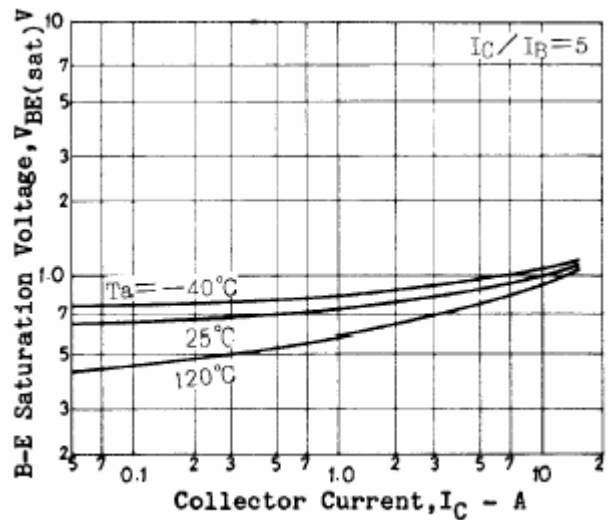

Fig.6 Base-Emitter Saturation Voltage

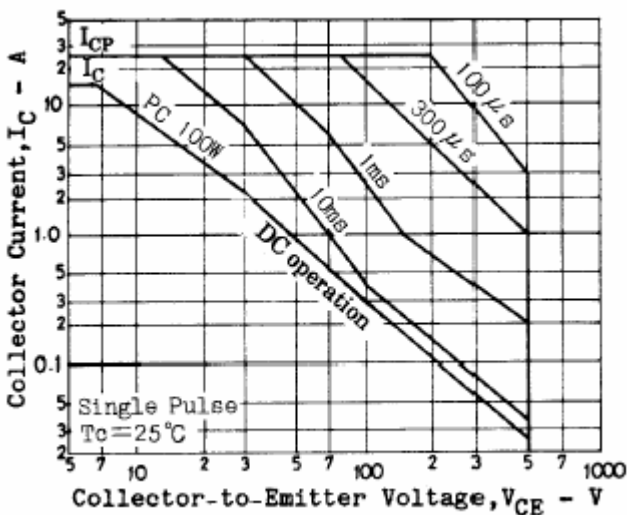

Fig.7 Safe Operating Area