

High Efficiency 1.5X charge Pump For White LEDs Backlighting

FEATURES

- 1MHz Switching Frequency
- 2.7V to 5.5V Input Voltage Range
- Low Shutdown Current: $\leq 1\mu\text{A}$
- Regulated 20mA Full-Scale Output Current
- 32-Position Linear Scale with Digital Control
- High Accuracy Brightness Matching
- 33% Less Input Current Than Doubler Charge Pump
- No Inductors Required
- Build-in Soft-Start
- Current Limit and Over Temperature Protection
- 12-Pin DFN Package

APPLICATIONS

- Cellular Phones
- PDAs
- Digital Still Cameras
- Handheld Devices
- White LED Backlighting

GENERAL DESCRIPTION

The AIC1843 provides 4 LED current source outputs with regulated constant current for uniform intensity. The AIC1843 is the low noise, constant frequency charge pump DC/DC converter that uses 1.5X conversion to increase efficiency in white LED applications. The devices can be used to produce current levels up to 20mA for each output from a 2.7V to 5.5V input. Low external parts counts (two $1\mu\text{F}$ flying capacitors and two small bypass capacitors at V_{IN} , and OUT) make the AIC1843 ideal for small, battery-powered applications.

EN/SET interface is used to enable, disable and set the LED current for a 32 level logic scale LED brightness control. Built-in current limiting, with thermal shutdown provides protection to the AIC1843 against fault conditions. Automatic soft-start circuitry prevents excessive inrush current during start-up. 1MHz high switching frequency is enable to use tiny external components.

The AIC1843 is available in a 12-pin thin DFN package.

TYPICAL APPLICATION CIRCUIT

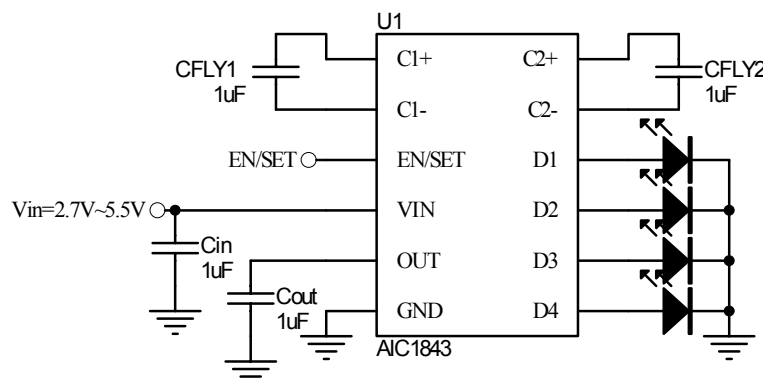

ORDERING INFORMATION

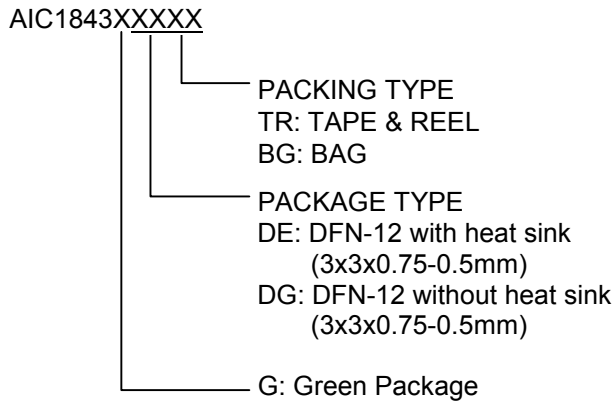

Example: AIC1843GDETR
 → in Green Package DFN-12 With Heat Sink Package and Tape & Reel Packing Type

AIC1843GDGTR
 → in Green Package DFN-12 Without Heat Sink Package and Tape & Reel Packing Type

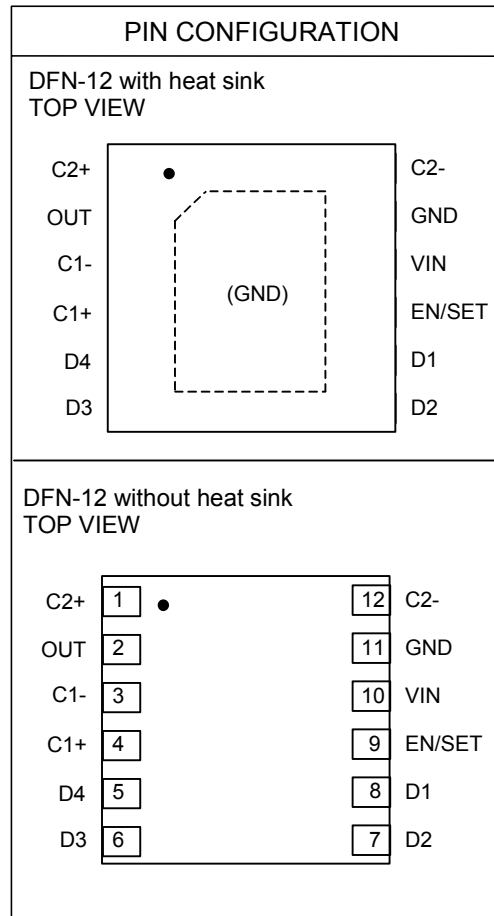

ABSOLUTE MAXIMUM RATINGS

VIN Voltage	6.0V
OUT pin Voltage.....	6.0V
EN/SET pin Voltage	6.0V
Operating Temperature Range	-40°C to 85°C
Junction Temperature	125°C
Storage Temperature Range	-65°C to 150°C
Lead Temperature (Soldering 10s).....	260°C
Thermal Resistance Junction to Ambient $R\theta_{JA}$ (Assume no ambient airflow, mounted on PCB)	
DFN-12 with heatsink.....	50°C /W
DFN-12 without heatsink.....	90°C /W

Absolute Maximum Ratings are those values beyond which the life of a device may be impaired.

■ ELECTRICAL CHARACTERISTICS

($V_{IN}=3.6V$, $EN/SET = IN$, $C_{IN} = C1 = C2 = C_{OUT} = 1 \mu F$, $T_A=25^\circ C$, Unless otherwise specified.)

(Note1)

PARAMETER	TEST CONDITIONS	MIN.	TYP.	MAX.	UNITS
Operating Voltage		2.7		5.5	V
Undervoltage-Lockout Threshold	V_{IN} falling	2.25	2.45	2.60	V
Undervoltage-Lockout Hysteresis			120		mV
Operating Current	Active, No Load Current		1	2	mA
Shutdown Current	$EN = 0$			1	μA
Output Current		18	20	22	mA
Output Current Line Regulation	$3.0V \leq V_{IN} \leq 5.5V$	-1.5		1.5	%/V
LED to LED Current Matching (Note2)			3	7	%
Soft-Start Time			400		μs
Switching Frequency		0.75	1	1.25	MHz
Enable Threshold Low	$V_{IN} = 2.7V$ to $5.5V$			0.5	V
Enable Threshold High	$V_{IN} = 2.7V$ to $5.5V$	1.4			V
EN/SET Low Time		0.3		75	μs
Minimum EN/SET High Time			50		ns
EN/SET Off Timeout			300	500	μs
EN/SET Input Leakage	$V_{IN} = 5.5V$	-1		1	μA
Thermal Shutdown Threshold			150		$^\circ C$
Thermal Shutdown Hysteresis			25		$^\circ C$

Note 1: Specifications are production tested at $T_A=25^\circ C$. Specifications over the $-40^\circ C$ to $85^\circ C$ operating temperature range are assured by design, characterization and correlation with Statistical Quality Controls (SQC).

Note 2: Current matching define: $(I_{LED1}-I_{LED2}) / (I_{LED1}+I_{LED2})$, between any two outputs

■ TYPICAL PERFORMANCE CHARACTERISTICS

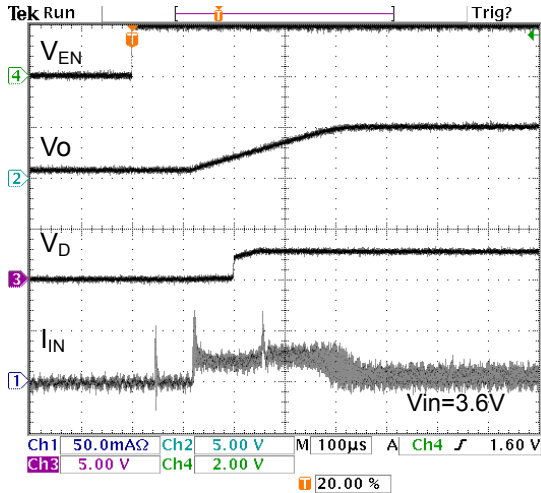

Fig1: Enable Transient Response

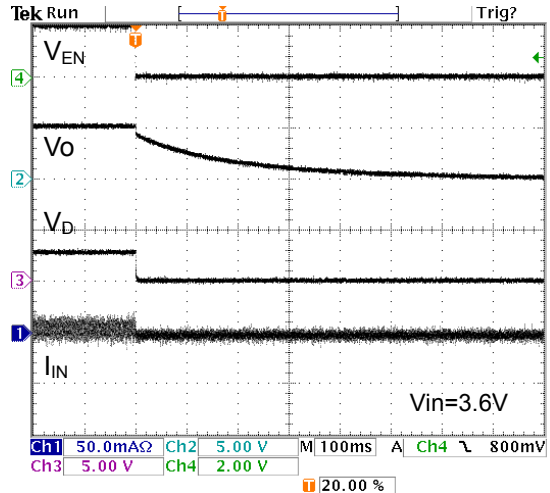

Fig2: Shutdown Timeout

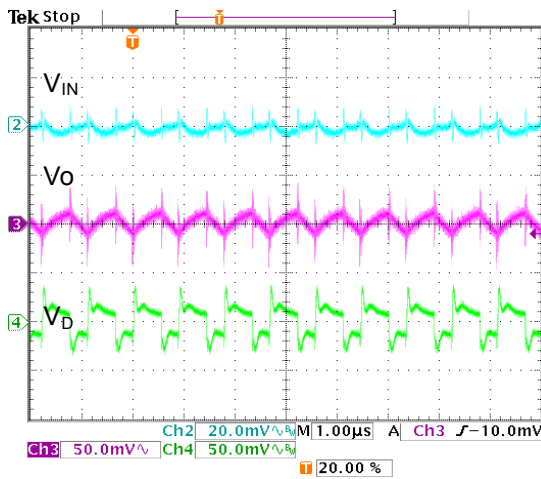

Fig3: 40mA load at Vin=3.0V

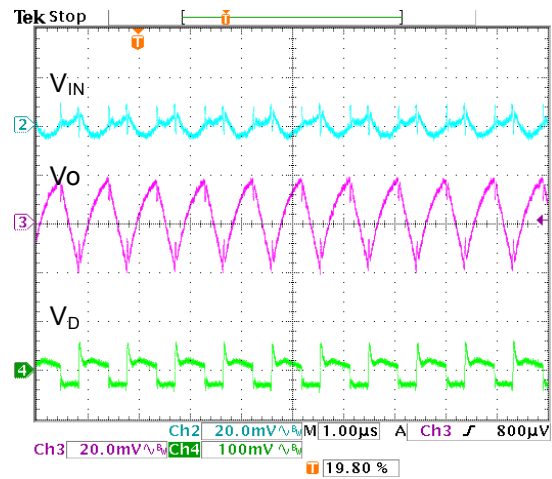

Fig4: 80mA load at Vin=3.0V

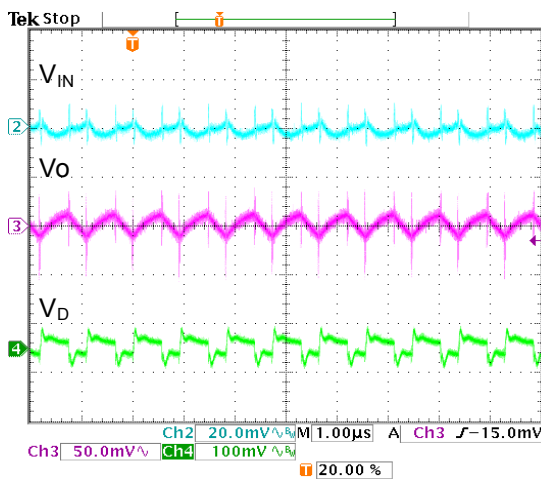

Fig5: 40mA load at Vin=3.6V

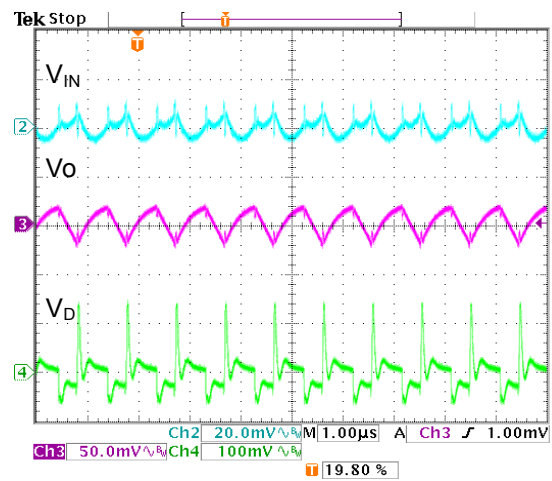

Fig6: 80mA load at Vin=3.6V

■ TYPICAL PERFORMANCE CHARACTERISTICS (Continued)

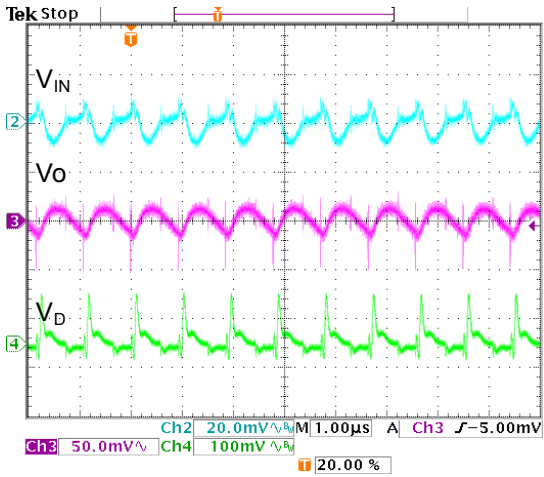

Fig7: 40mA load at Vin=4.2V

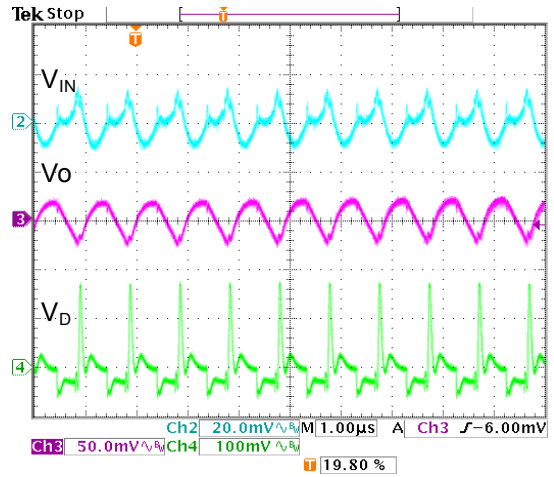

Fig8: 80mA load at Vin=4.2V

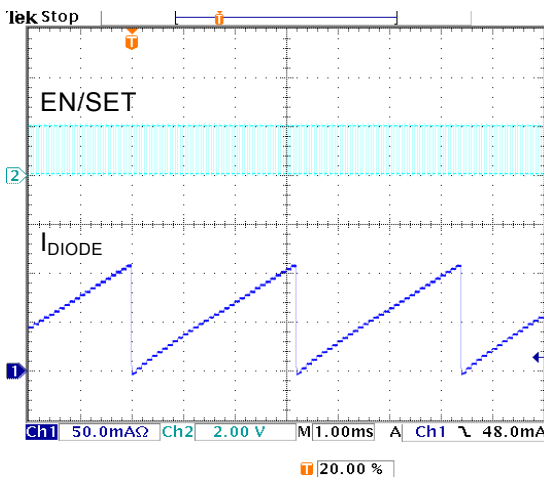

Fig6: EN/SET Pin 10kHz Clock Transient

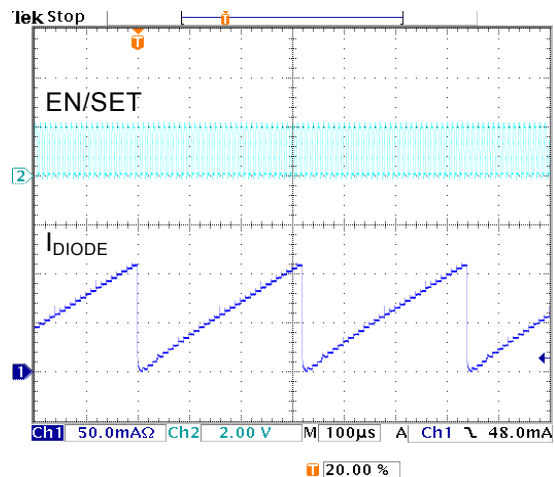

Fig7: EN/SET Pin 100kHz Clock Transient

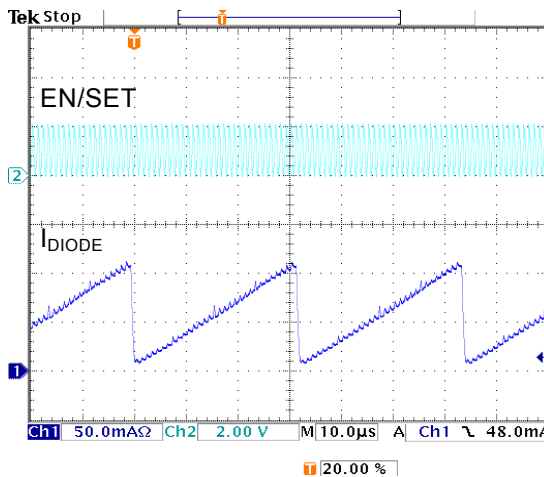

Fig8: EN/SET Pin 1MHz Clock Transient

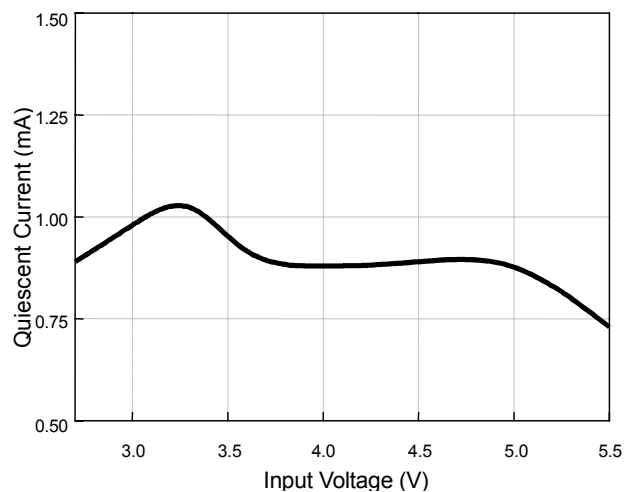

Fig12: Quiescent Current vs. Input Voltage

■ TYPICAL PERFORMANCE CHARACTERISTICS (Continued)

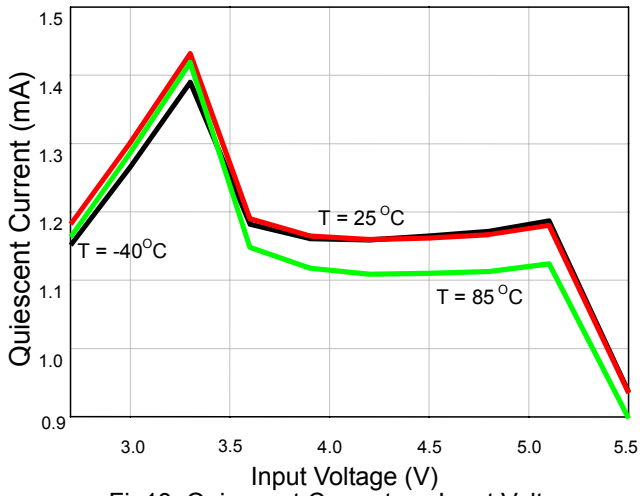

Fig13: Quiescent Current vs. Input Voltage

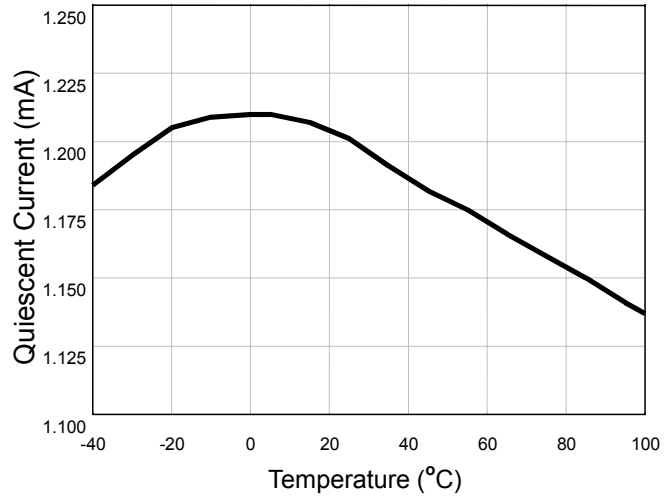

Fig14: Quiescent Current vs. Temperature

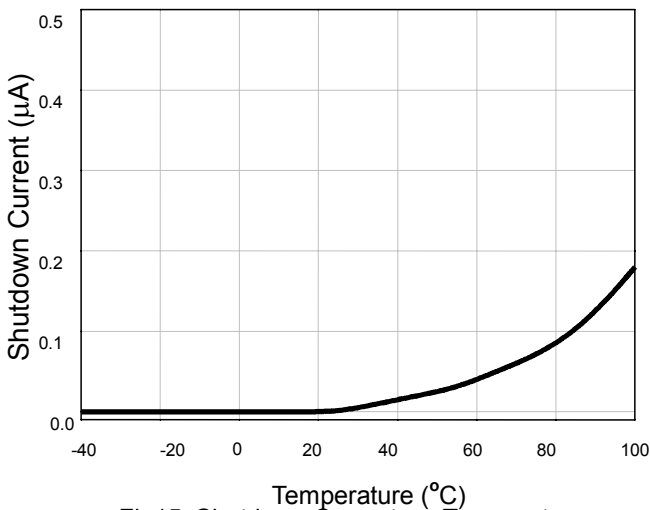

Fig15: Shutdown Current vs. Temperature

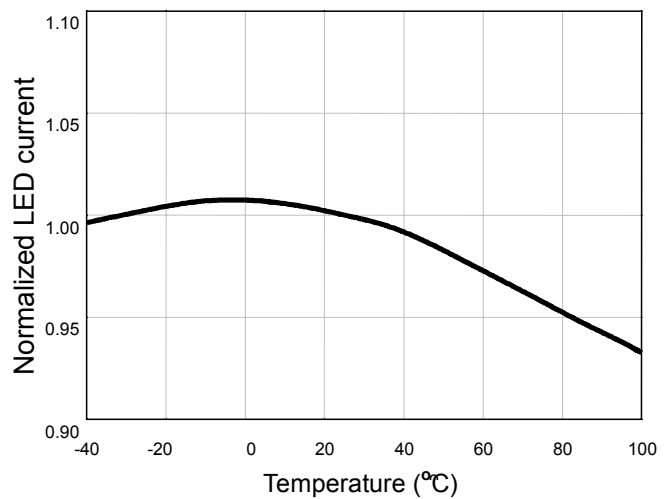

Fig16: Normalized LED Current vs. Temperature

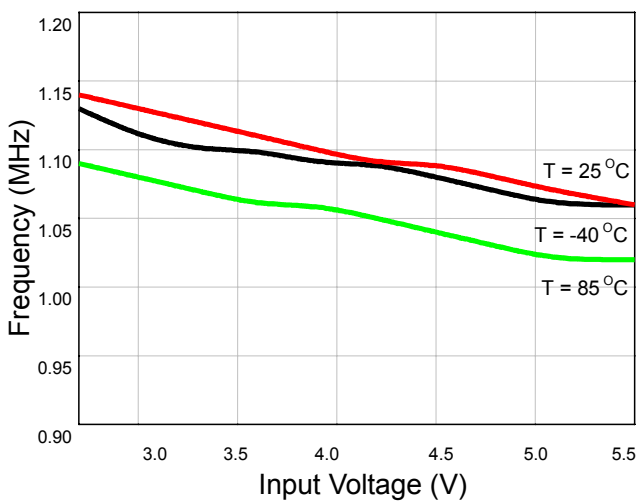

Fig17: Frequency vs. Input Voltage

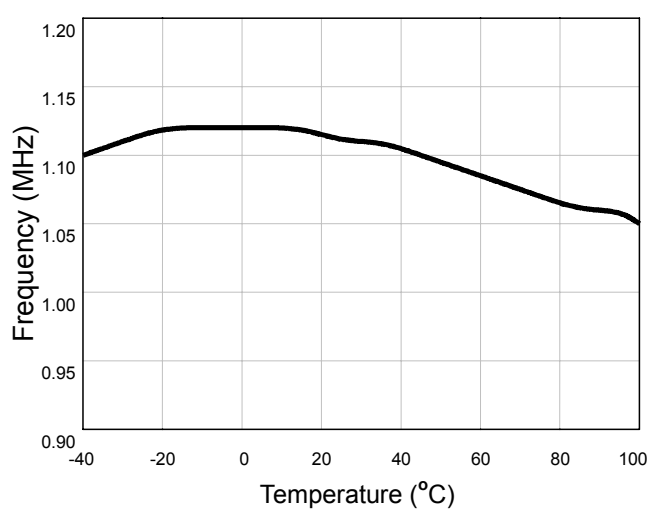

Fig18: Frequency vs. Temperature

■ TYPICAL PERFORMANCE CHARACTERISTICS (Continued)

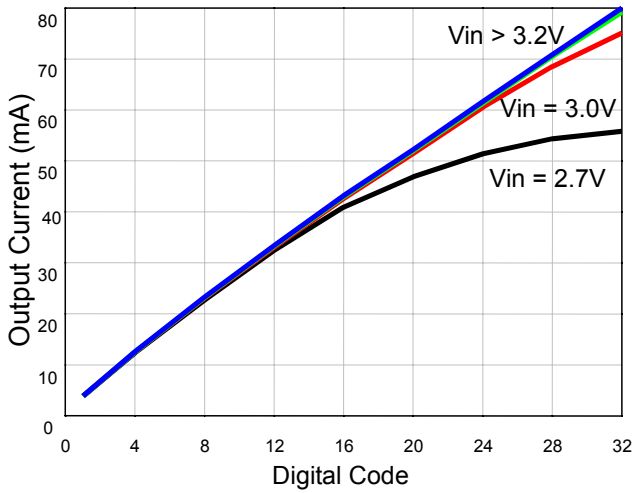

Fig19: 32 Levels Current Setting with 4 LEDs

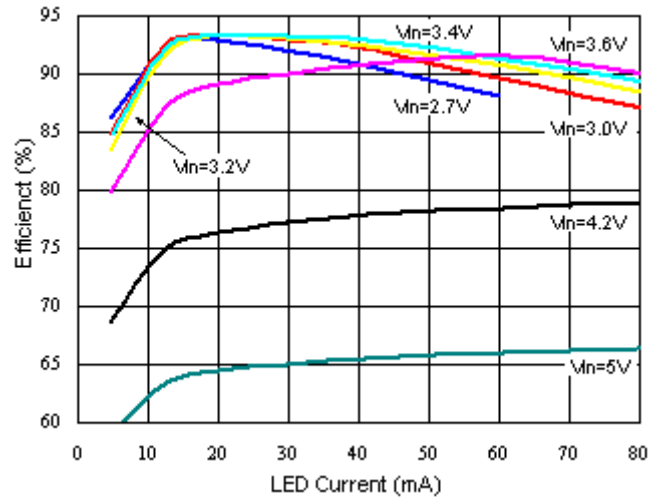

Fig20: Efficiency vs. Supply Current

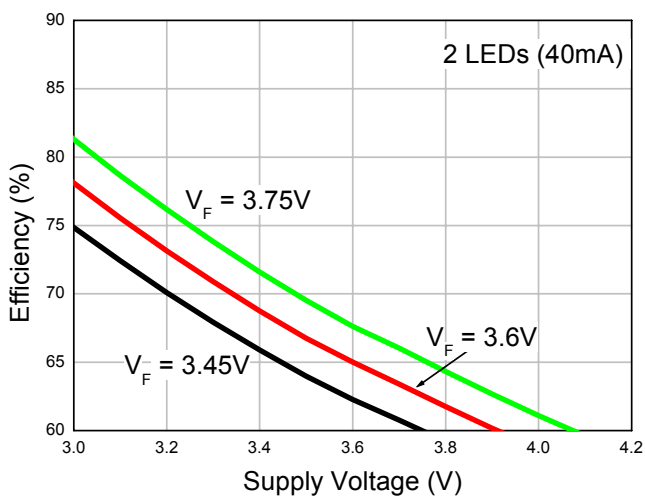

Fig21: Efficiency vs. Supply Voltage

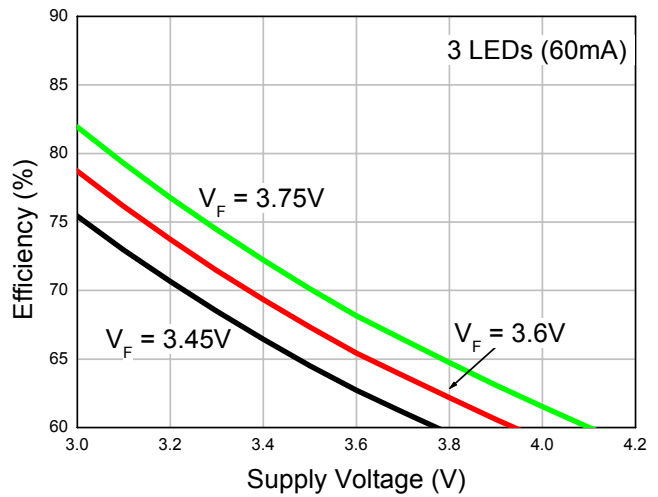

Fig22: Efficiency vs. Supply Voltage

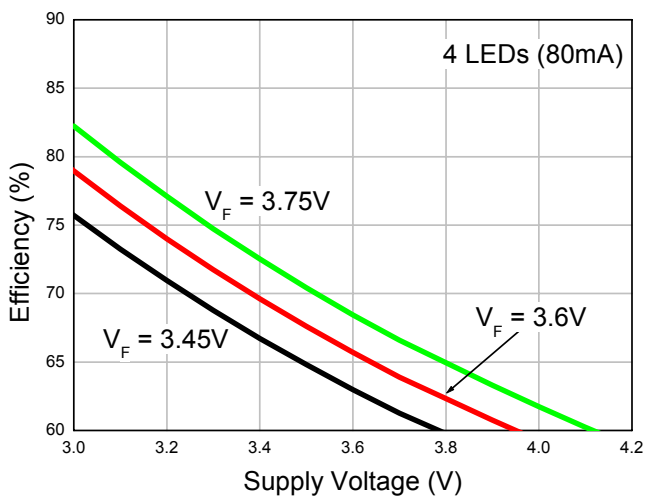
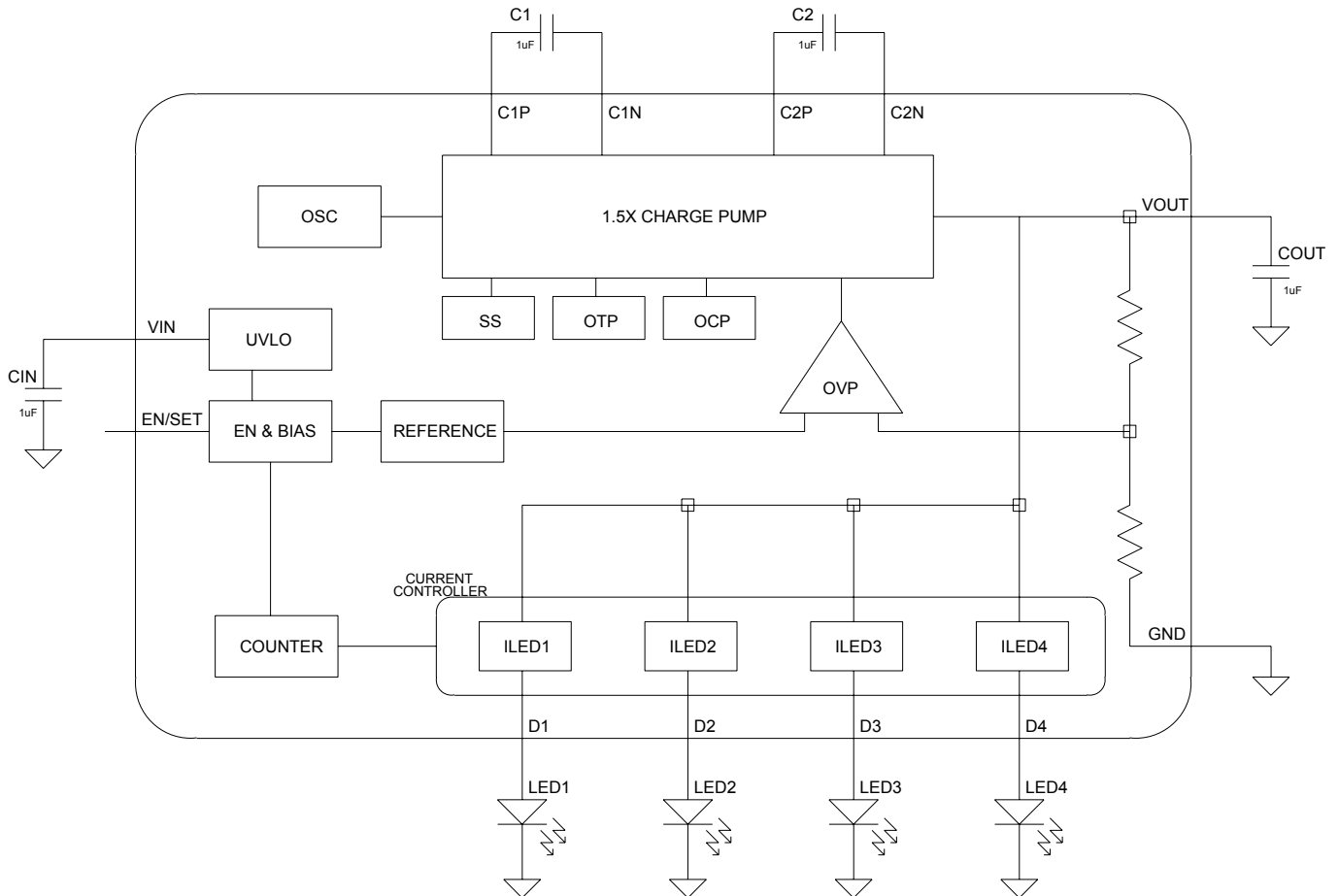

Fig23: Efficiency vs. Supply Voltage

■ BLOCK DIAGRAM



■ PIN DESCRIPTIONS

- D1: Current source output.
- D2: Current source output.
- D3: Current source output.
- D4: Current source output.
- C1+: Flying capacitor 1 positive terminal.
- C1-: Flying capacitor 1 negative terminal.
- C2+: Flying capacitor 2 positive terminal.
- C2-: Flying capacitor 2 negative terminal.
- OUT: Charge pump output. For the best

performance, OUT should bypass a 1 μ F (min.) low ESR ceramic capacitor with the shortest distance to ground.

GND: Ground. Connect GND as close as possible to system ground and to the ground of the input bypass capacitor.

VIN: Input supply voltage. Bypass a 1 μ F (min.) low ESR ceramic capacitor to GND as close to device as possible. The input voltage range is 2.7V to 5.5V.

EN/SET: Enable and current set pin.

■ APPLICATION INFORMATION

Operation

The AIC1843 is a high efficiency 1.5X charge pumps intended for WLED backlighting. This kind of converter uses capacitors to store and transfer energy. Since the capacitors can't change to the voltage level abruptly, the voltage ratio of V_{OUT} to V_{IN} is limited. Capacitive voltage conversion is obtained by switching a capacitor periodically. Refer to Fig. 20, during the “on” state of internal clock, Q₁, Q₄ and Q₇ are closed, which charges C_{FLY1} and C_{FLY2} to $1/2V_{IN}$ level. During the “off” state, Q₂, Q₃, Q₅ and Q₆ are closed. The output voltage is V_{IN} plus V_{CFLY} , that is, $1.5V_{IN}$.

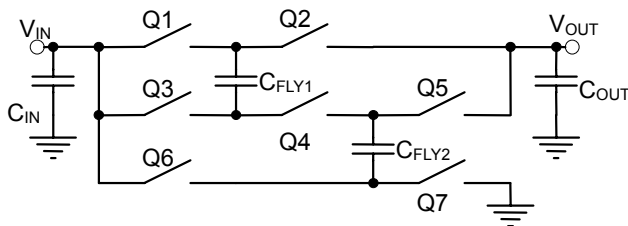

Fig. 20 The circuit of 1.5X charge pump

The AIC1843 only requires one $1\mu\text{F}$ ceramic capacitor for C_{IN} , one $1\mu\text{F}$ ceramic capacitor for C_{OUT} and two $1\mu\text{F}$ ceramic capacitors for the charge pump flying capacitors.

Efficiency

The efficiency of AIC1843 for ideal 1.5X charge pump can be simply defined as:

$$\eta = \frac{P_{OUT}}{P_{IN}} = \frac{V_{OUT} \times I_{OUT}}{V_{IN} \times I_{IN}} = \frac{V_{OUT} \times I_{OUT}}{V_{IN} \times 1.5I_{OUT}} = \frac{V_{OUT}}{1.5V_{IN}}$$

The actual efficiency will decrease as the result from internal switching loss.

WLED Current Level Setting

The AIC1843 D1 to D4 are constant current outputs which source up to 20mA respectively to drive four WLEDs. The LED current is set via serial interface by the EN/SET pin, which is based on a digital scale. The interface records rising edges of the EN/SET pin, and counts them into 32 current level settings where each code is 0.625mA greater than previous code. Code 1 is the lowest current scale, 0.625mA, and Code 32 is full scale, 20mA. The LED current appears linear with each increasing code. The first rising edge enables the device and sets the LED output current to the lowest setting level, 0.625mA. After 32nd clock, the LED output returns to state 1. The EN/SET pin has to remain high to keep the LED output current to programmed level when the final clock is input.

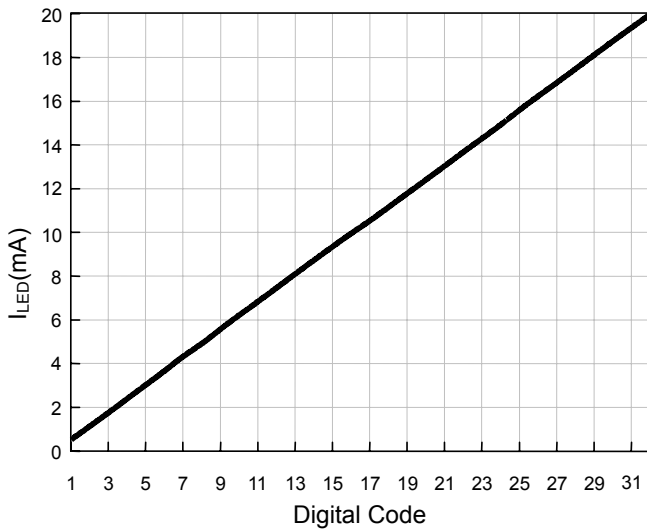

Code	WLED Current	Code	WLED Current
1	0.625	17	10.625
2	1.250	18	11.250
3	1.875	19	11.875
4	2.500	20	12.500
5	3.125	21	13.125
6	3.750	22	13.750
7	4.375	23	14.375
8	5.000	24	15.000
9	5.625	25	15.625
10	6.250	26	16.250
11	6.875	27	16.875
12	7.500	28	17.500
13	8.125	29	18.125
14	8.750	30	18.750
15	9.375	31	19.375
16	10.000	32	20.000

EN/SET Interface

The EN/SET timing is as the diagram shown below. The first rising edge enables the device and sets the LED output current to the lowest setting level. The AIC1843 reaches full capacity after typically 400us soft start time. During the soft start period, multiple clock pulses may be inserted, they will be missed cause the counter of EN/SET interface will work after soft start time.

The 2nd pulse should be later than 1st pulse for a soft start time at least to maintain a correct LED output current level. The counter can be clocked up to 1MHz, so the intermediate scales are not visible. The EN/SET has to hold high to keep the output LED current to programmed level when the final clock is input. When the EN/SET keeps a low for the t_{SHDN} timeout period or longer, the AIC1843 is shutdown.

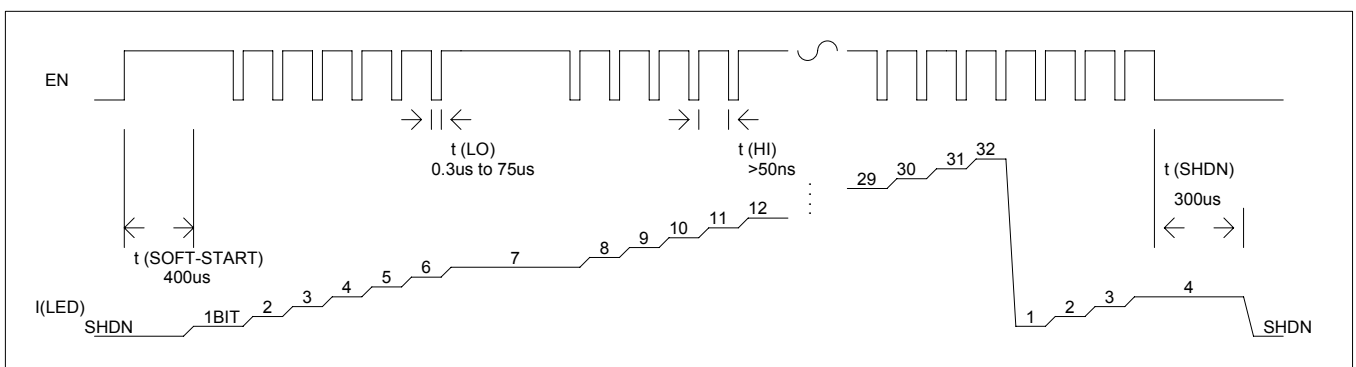

Current Setting Diagram

Open-Circuit Protection

In any cases of open output circuit, the LEDs are disconnected from the circuit or the LEDs are failed, etc., the output voltage will limit approximately to 5V.

Thermal Protection

When the temperature of device exceeds approximately 150°C, the thermal protection will shut the switching down and the temperature will reduce afterwards. Once the temperature drops below approximately 125°C, the charge pump switching circuit will re-start. Even though all four outputs shorted to ground at maximum 80mA, the die temperature will not increase sufficiently to enable the thermal protection resulting from its low thermal resistance.

Capacitor Selection

Four external capacitors, C_{IN} , C_{OUT} , C_{FLY1} , and C_{FLY2} , determine AIC1843 performances. Optimum performance can be obtained by using low ESR ceramic capacitors. A 1uF ceramic capacitor for all four capacitors is recommended

for general application.

To reduce noise and ripple, low ESR ceramic capacitor is recommended for C_{IN} and C_{OUT} . The value of C_{OUT} determines the amount of output ripple voltage. An output capacitor with larger value results in smaller ripple. C_{FLY} is critical for the charge pump which affects turn on time. The larger C_{FLY} is, the higher output current obtains. However, large C_{IN} and C_{OUT} are required when large C_{FLY} applies. The ratio of C_{IN} (as well as C_{OUT}) to C_{FLY} should be approximately 1:1 to 10:1.

Layout Considerations

Due to the switching frequency and high transient current of AIC1843, careful consideration of PCB layout is necessary. The C_{IN} should be connected as close to the IC as possible. The ground of C_{IN} and C_{OUT} should be placed as close as possible. To achieve the best performance of AIC1843, minimize the distance between every two components and also minimize every connection length with a maximum trace width. Make sure each device connects to immediate ground plane.

Application Example

I. When using the AIC1843 to drive fewer than four LEDs, keep current output float. The

corresponding LED current still enables.

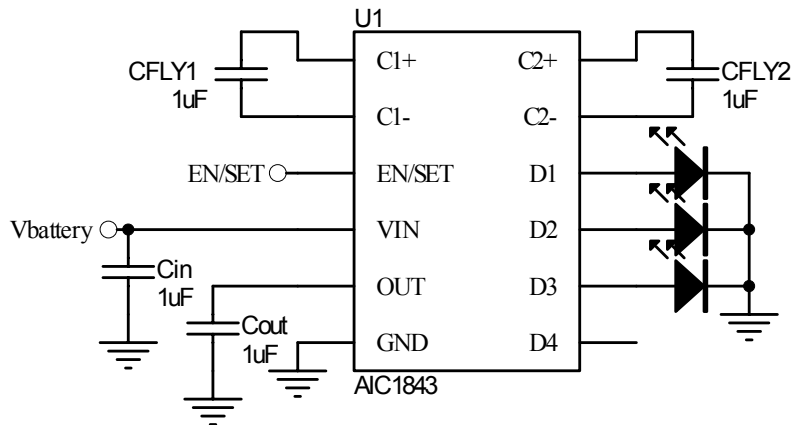

II. Any combination of output may be connected in parallel to deliver a single power output to drive a LED module. The maximum output current is the sum of parallel-connected

current source. This feature is useful to drive pre-wire LED backlight modules, which is connected in parallel structure circuit.

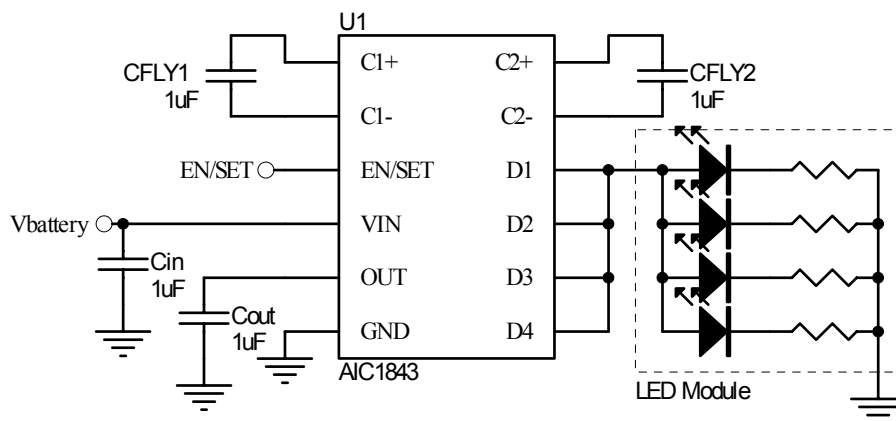

PHYSICAL DIMENSIONS (unit: mm)

- DFN-12 with heat sink (3x3x0.75-0.5mm)

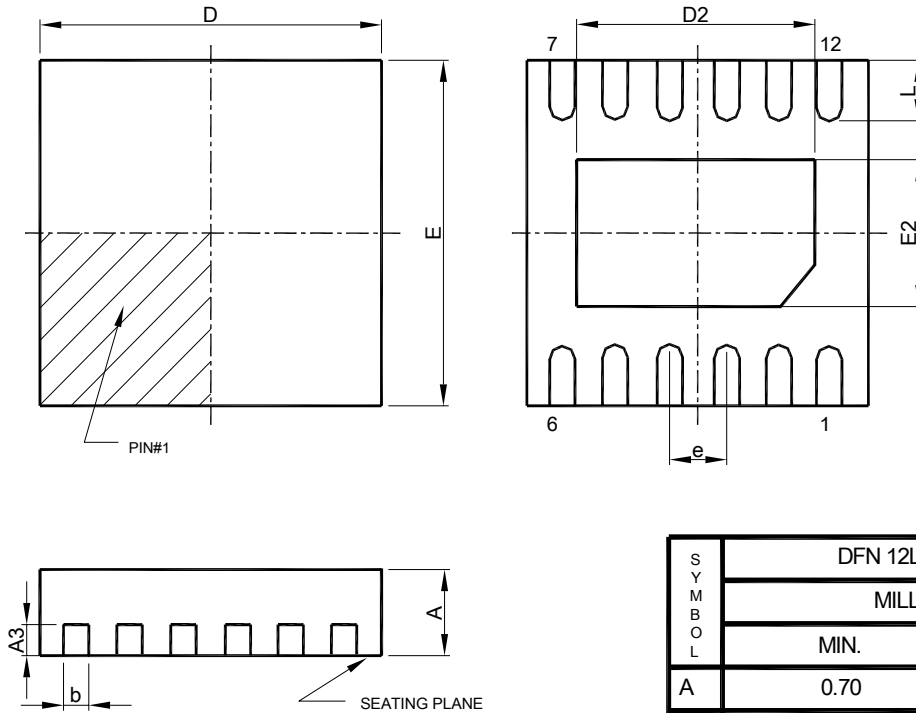

SYMBOL	DFN 12L-3x3x0.75-0.5mm	
	MILLIMETERS	
	MIN.	MAX.
A	0.70	0.80
A3	0.20 BSC	
b	0.18	0.30
D	2.90	3.10
D2	2.20	2.40
E	2.90	3.10
E2	1.60	1.80
e	0.50 BSC	
L	0.35	0.45

Note :

1. DIMENSION AND TOLERANCING CONFORM TO ASME Y14.5M-1994.
2. CONTROLLING DIMENSIONS : MILLIMETER , CONVERTED INCH DIMENSION ARE NOT NECESSARILY EXACT.

- **DFN-12 without heat sink (3x3x0.75-0.5mm)**

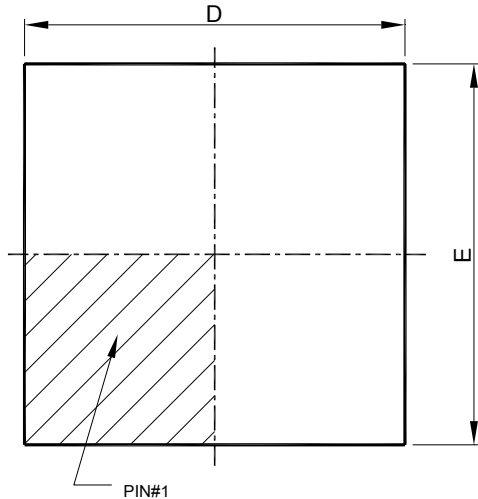

TOP VIEW

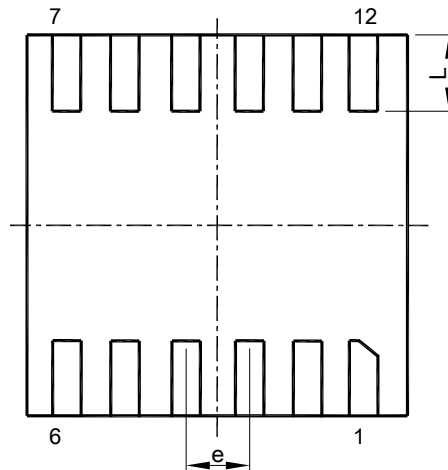

BOTTOM VIEW

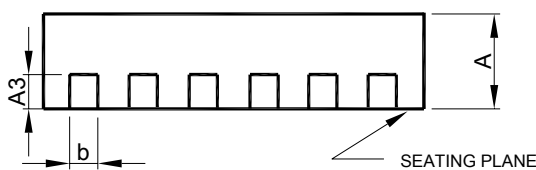

SIDE VIEW

SYMBOL	DFN 12L-3x3x0.75-0.5mm (Without Heat Sink)	
	MILLIMETERS	
	MIN.	MAX.
A	0.70	0.80
A3	0.203 BSC	
b	0.20	0.30
D	2.90	3.10
E	2.90	3.10
e	0.500 BSC	
L	0.60	0.70

Note : 1. DIMENSION AND TOLERANCING CONFORM TO ASME Y14.5M-1994.
 2. CONTROLLING DIMENSIONS : MILLIMETER , CONVERTED INCH DIMENSION ARE NOT NECESSARILY EXACT.

Note:

Information provided by AIC is believed to be accurate and reliable. However, we cannot assume responsibility for use of any circuitry other than circuitry entirely embodied in an AIC product; nor for any infringement of patents or other rights of third parties that may result from its use. We reserve the right to change the circuitry and specifications without notice.

Life Support Policy: AIC does not authorize any AIC product for use in life support devices and/or systems. Life support devices or systems are devices or systems which, (i) are intended for surgical implant into the body or (ii) support or sustain life, and whose failure to perform, when properly used in accordance with instructions for use provided in the labeling, can be reasonably expected to result in a significant injury to the user.