



PRODUCT SPECIFICATION

Model No : CSLO-U34SHR1-QA0R

Descriptions:
■ LED Type : Superbright Lamp
■ LED Package : Oval LED Lamp
■ Emitting Color : Red
■ Viewing Angle : 110°/40°
■ Stopper



CUSTOMER APPROVED SIGNATURES	APPROVED BY	CHECKED BY	PREPARED BY

CHINA SEMICONDUCTOR CORPORATION
Address: 2FL. NO.909, Chung-Cheng Road,
Chung-Ho City Taipei Hsien, Taiwan.

Tel: 886-2-2223-9696
Fax: 886-2-2223-9377

OPTO PLUS TECHNOLOGIES CO.,LTD
Address: 696 Shun jiang Rd., Ji Shan St. Shaoxing,
ZheJiang, China

Tel: 86-0575-88623888
Fax: 86-0575-88623112



Model No : CSLO-U34SHR1-QA0R

■ Features -

1. Low Power Consumption.
2. High Luminous Output
3. High Reliability and Solid Performance
4. Optimal Optical/Mechanical Design
5. Rohs Compliant

■ Device Selection Guide -

Part No.	Chip		LED Lens
	Material	Emitted Color	
CSLO-U34SHR1-QA0R	AlInGaP	Red	Red Diffused

■ Package Outline Dimensions -

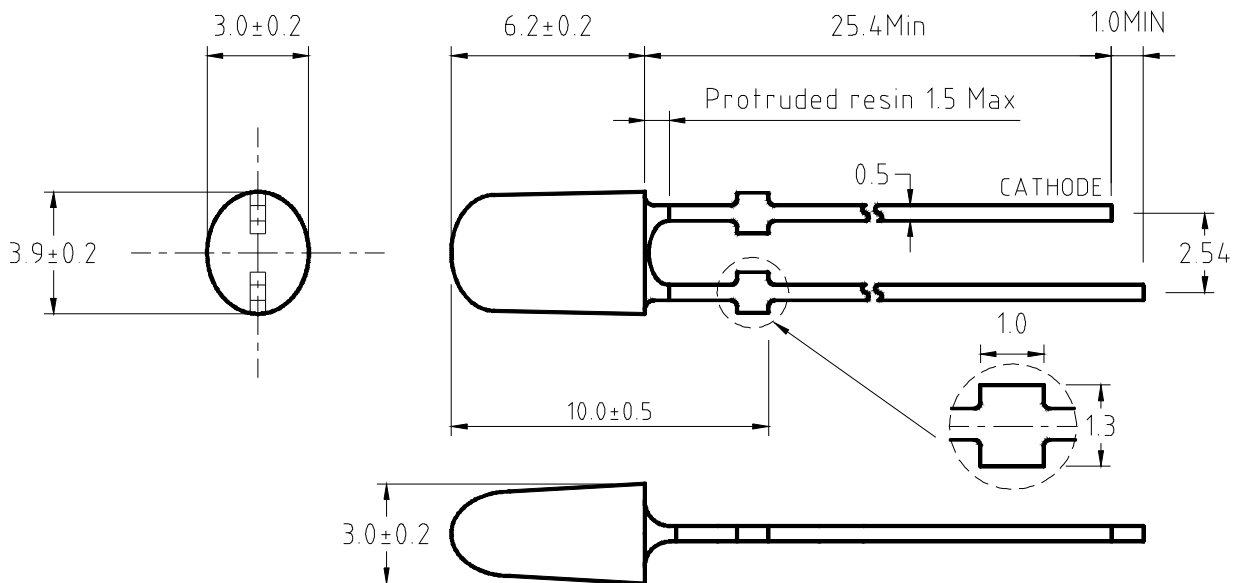

* Tolerance : $\pm \frac{0.01}{0.25}$ Unit : $\pm \frac{\text{inch}}{\text{mm}}$



Model No : CSLO-U34SHR1-QA0R

■ Absolute Maximum Rating -

(Ta=25°C)

Parameter	Symbol	Rating	Unit
Power Dissipation	Pd	120	mW
Forward Current (DC)	IF	50	mA
Peak Forward Current *	IFP	100	mA
Reverse Voltage	VR	5	V
Operating Temp.	Topr	-30 ~ +85	°C
Storage Temp.	Tstg	-40 ~ +100	°C
Lead Soldering Temperature	Tsol	Max. 260°C for 5 sec Max. (3mm from the epoxy bulb)	

* Pulse width \leq 0.1 msec. duty \leq 1/10

■ Electro-optical Characteristics -

(Ta=25°C)

Parameter	Symbol	Min.	Typ.	Max.	Unit	Condition
Forward Voltage	VF	-----	2.1	2.4	V	IF=20mA
Luminous Intensity	Iv	680	800	1900	mcd	
Dominant Wavelength	λ_d	615	525	635	nm	
Peak Wavelength	λ_p	-----	635	-----	nm	
Spectral Half Width	$\Delta\lambda_{1/2}$	-----	15	-----	nm	
Viewing Angle	$2\theta_{1/2}$	-----	110(X) 40(Y)	-----	deg	
Reverse Current	IR	-----	-----	50	μ A	VR=5V



Model No : CSLO-U34SHR1-QA0R

■ Luminous Intensity Rank Limits ($I_F = 20\text{mA}$)

unit : mcd

Code	Part No. CSLO-U34SHR1-QA0R	
	min.	max.
N	680	880
P	880	1150
Q	1150	1500
R	1500	1900

■ Color Rank Limits ($I_F = 20\text{mA}$)

unit : nm

Code	Part No. CSLO-U34SHR1-QA0R	
	min.	max.
1	615	620
2	620	625
3	625	630
4	630	635

Notes:

1. Tolerance of measurement of luminous intensity :±15%
2. Tolerance of measurement of Color Coordinates :±0.01
3. Tolerance of measurement of forward voltage :±0.05v
4. All data are measured by CSC's test equipment.
5. One delivery will include several color rank, VF rank and Iv ranks of the products.
6. The quantity-ratio of the ranks is decided by CSC.
7. Please confirm with CSC salesman,if your request different form standard specification.



Model No : CSLO-U34SHR1-QA0R

Typical Electrical / Optical Characteristics Curves -

(Ta = 25°C Unless Otherwise Noted)

Forward Current vs. Forward Voltage

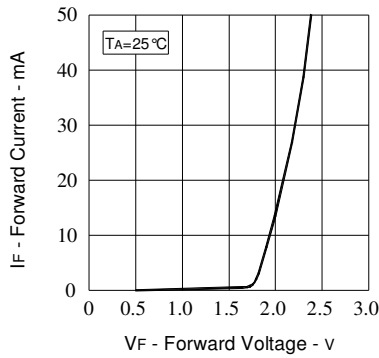

Relative Intensity vs. Forward Current

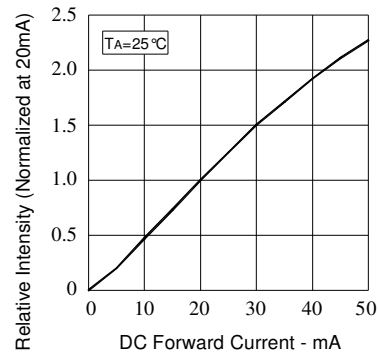

Forward Current vs. Ambient Temperature

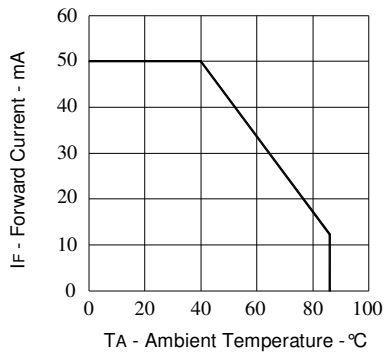

Relative Intensity vs. Wavelength

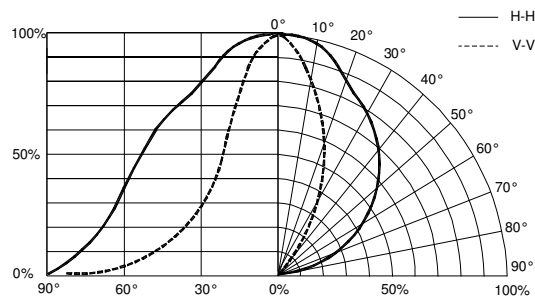
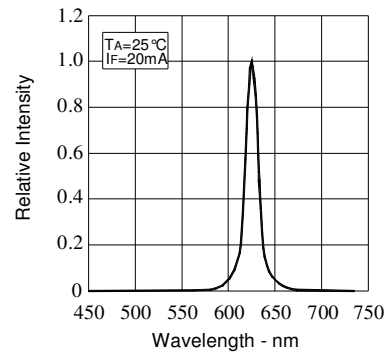
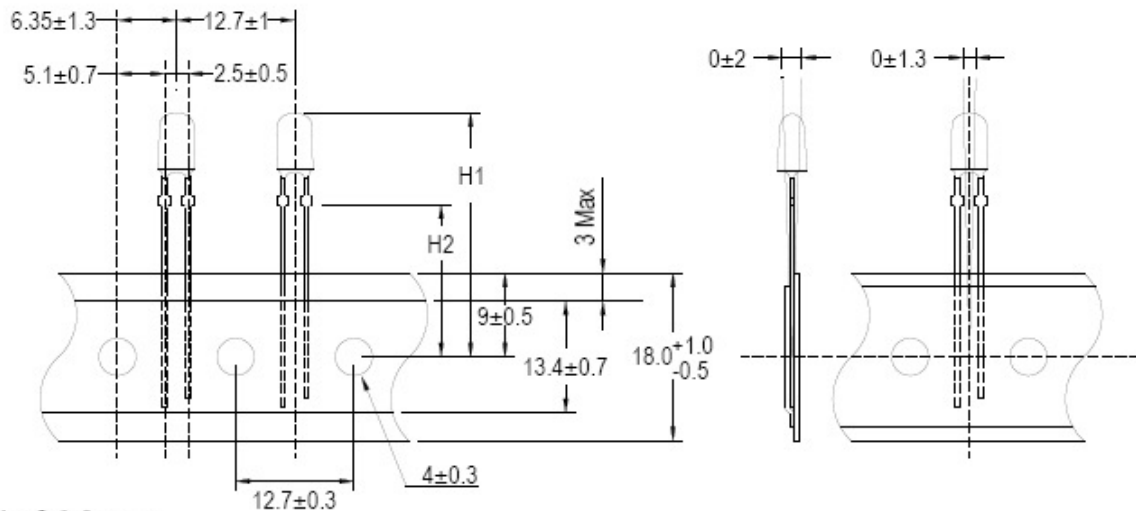

Fig 6. Relative Luminous Intensity vs. Radiation Angle



Model No : CSLO-U34SHR1-QA0R

Taping Dimensions



H1=26.0mm

H2=16.0mm

1. The cumulative tolerance for pitch of the sprocket holes is ± 1 mm per 20 pitches
2. The cathode side must be drawn out first
3. The minimum order quantity for taped LEDs is 10K pieces

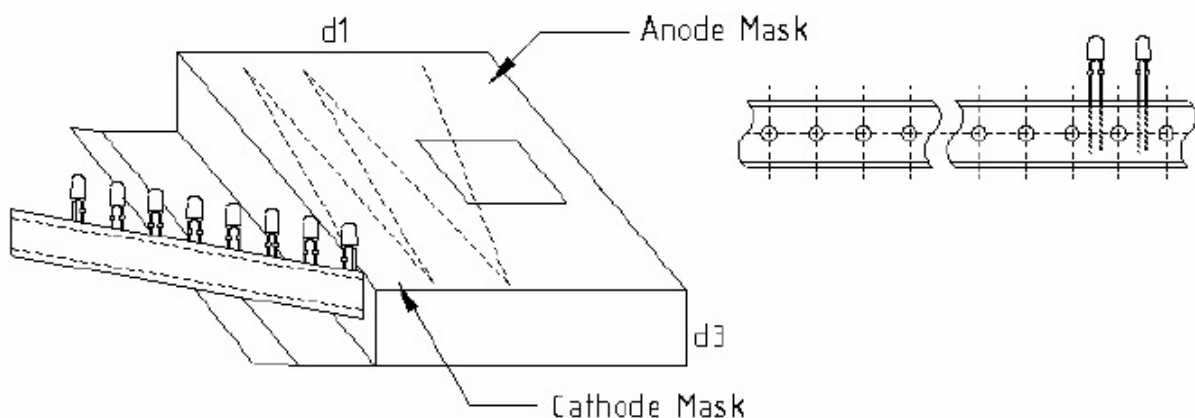

d1=285mm

d3= 50mm

1. The tape is folded every 25 elements
2. At each end of the tape there is an empty length of equal to more than 10 elements spacing of tape
3. The cathode side must be drawn out first



Model No : CSLO-U34SHR1-QA0R

■ Precautions For Use -

1. Recommended Soldering conditions

Wave Soldering

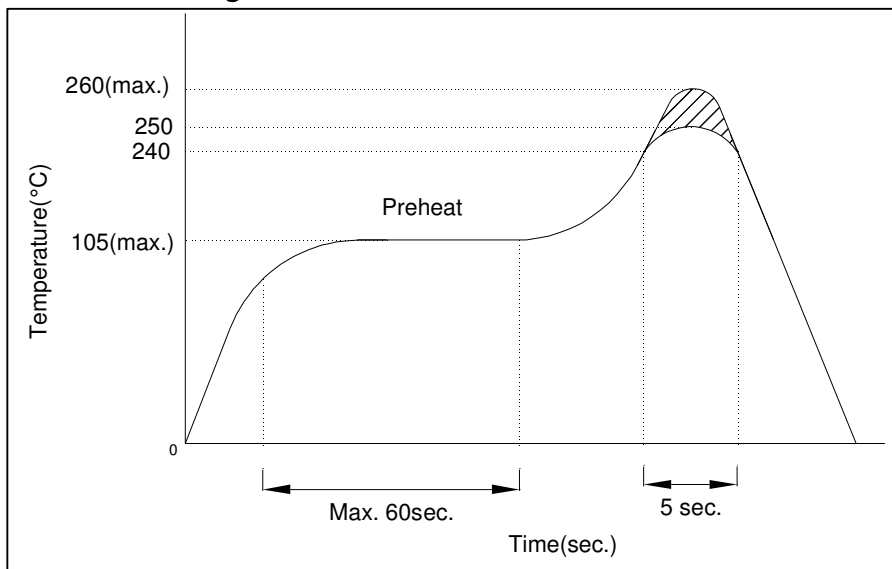

2. Soldering Iron

Basic SPEC. is ≤ 5 sec. When 260°C . If temperature is higher, time should be shorter ($+10^{\circ}\text{C} \rightarrow -1$ sec.). Power dissipation of iron should be smaller than 15W, and temperature should be controllable. Surface temperature of the device should be under 230°C .

3. Static Electricity

- a. Static electricity or surge voltage damages LEDs..

It is recommended that a wrist band or an anti-electrostatic glove be used when handling the LEDs.

- b. All devices, equipment and machinery must be properly grounded. It is recommended that measures be taken against surge voltage to the equipment that mounts the LEDs.

Note: The specifications are subject to change without notice. Please contact us for updated information.