

1. PART NO. EXPRESSION :

PDC0504100MZ F

(a) (b) (c) (d)(e)(f)

(a) Series code

(b) Dimension code

(c) Inductance code : 100 = 10uH

(d) Tolerance code : K = ±10%, M = ±20%

(e) X, Y, Z : Standard part

(f) F : Lead Free

2. CONFIGURATION & DIMENSIONS :

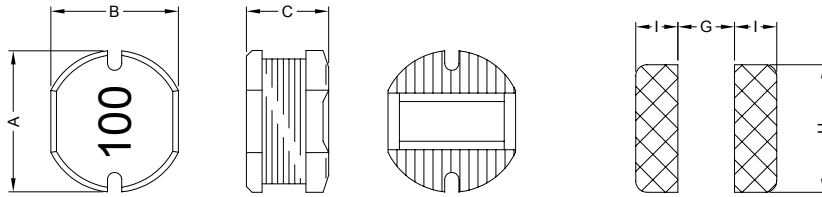

PCB Pattern

Unit : mm

A	B	C	G	H	I
5.8±0.3	5.2±0.3	4.50±0.35	1.70 Ref.	5.50 Ref.	2.15 Ref.

3. SCHEMATIC :

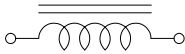

4. MATERIALS :

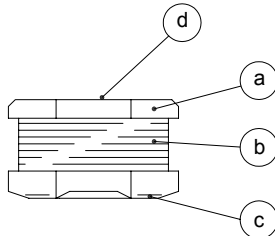

(a) Core : DR Ferrite Core

(b) Wire : Enamelled Copper Wire

(c) Terminal : Ag+Cu+Ni+Sn

(d) Ink : Bon Margue

5. GENERAL SPECIFICATION :

- a) Temp. rise : 40°C Max.
- b) Rated current : Base on temp. rise & $\Delta L/L0A = 10\%$ Max.
- c) Storage temp. : -40°C to +125°C
- d) Operating temp. : -40°C to +85°C
- e) Resistance to solder heat : 260°C.10 secs



RoHS Compliant

NOTE : Specifications subject to change without notice. Please check our website for latest information.

01.05.2008



SUPERWORLD ELECTRONICS (S) PTE LTD

6. ELECTRICAL CHARACTERISTICS :

Part No.	Inductance (μ H)	Test Frequency (Hz)	RDC (Ω) Max.	IDC (A) Max.
PDC05041R0MZF	1.0 \pm 20%	7.96M	0.015	5.90
PDC05041R2MZF	1.2 \pm 20%	7.96M	0.020	5.20
PDC05041R5MZF	1.5 \pm 20%	7.96M	0.025	4.70
PDC05041R8MZF	1.8 \pm 20%	7.96M	0.030	4.00
PDC05042R2MZF	2.2 \pm 2.0%	7.96M	0.035	3.80
PDC05042R7MZF	2.7 \pm 2.0%	7.96M	0.040	3.40
PDC05043R3MZF	3.3 \pm 20%	7.96M	0.045	3.30
PDC05043R9MZF	3.9 \pm 20%	7.96M	0.050	2.90
PDC05044R7MZF	4.7 \pm 20%	7.96M	0.060	2.80
PDC05045R6MZF	5.6 \pm 20%	7.96M	0.070	2.40
PDC05046R8MZF	6.8 \pm 20%	7.96M	0.080	2.10
PDC05048R2MZF	8.2 \pm 20%	7.96M	0.090	2.00
PDC0504100MZF	10 \pm 20%	2.52M	0.100	1.44
PDC0504120MZF	12 \pm 20%	2.52M	0.120	1.40
PDC0504150MZF	15 \pm 20%	2.52M	0.140	1.30
PDC0504180MZF	18 \pm 20%	2.52M	0.150	1.23
PDC0504220MZF	22 \pm 20%	2.52M	0.180	1.11
PDC0504270MZF	27 \pm 20%	2.52M	0.200	0.97
PDC0504330KZF	33 \pm 10%	2.52M	0.230	0.88
PDC0504390KZF	39 \pm 10%	2.52M	0.320	0.80
PDC0504470KZF	47 \pm 10%	2.52M	0.370	0.72
PDC0504560KZF	56 \pm 10%	2.52M	0.420	0.68
PDC0504680KZF	68 \pm 10%	2.52M	0.460	0.61
PDC0504820KZF	82 \pm 10%	2.52M	0.600	0.58
PDC0504101KZF	100 \pm 10%	1V/1K	0.700	0.52
PDC0504121KZF	120 \pm 10%	1V/1K	0.930	0.48
PDC0504151KZF	150 \pm 10%	1V/1K	1.100	0.40
PDC0504181KZF	180 \pm 10%	1V/1K	1.380	0.38
PDC0504221KZF	220 \pm 10%	1V/1K	1.570	0.35



RoHS Compliant

NOTE : Specifications subject to change without notice. Please check our website for latest information.

01.05.2008



SUPERWORLD ELECTRONICS (S) PTE LTD

7. CHARACTERISTICS CURVES :

@ TEMP. RISE VS. DC SUPERPOSITION RESPONSE CURVE

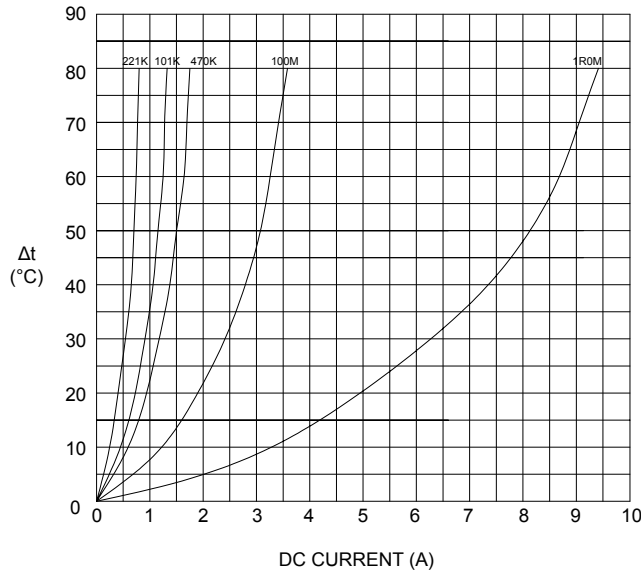

@ INDUCTANCE VS. FREQUENCY RESPONSE CURVE

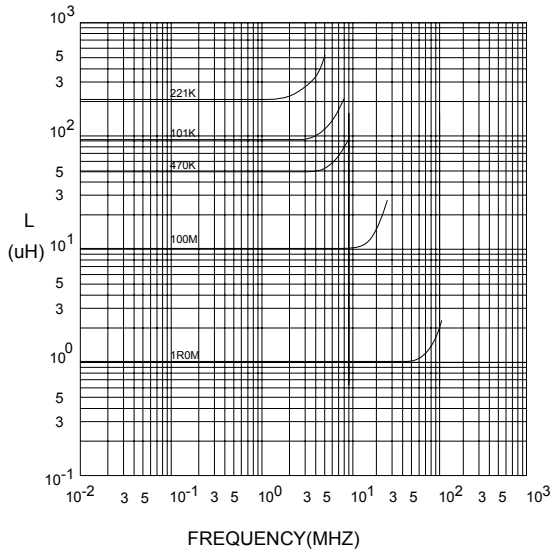

@ INDUCTANCE VS. DC SUPERPOSITION RESPONSE CURVE

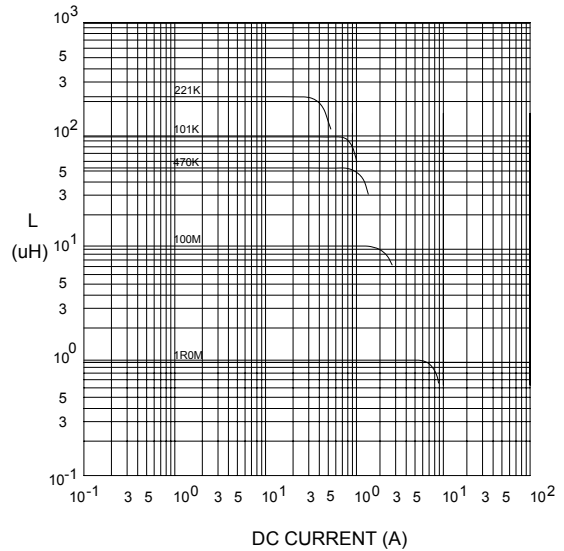

NOTE : Specifications subject to change without notice. Please check our website for latest information.



RoHS Compliant

01.05.2008



SUPERWORLD ELECTRONICS (S) PTE LTD

RECOMMENDED SOLDERING CONDITIONS REFLOW SOLDERINGS

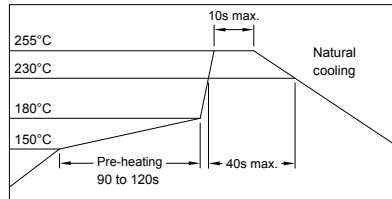

8. PACKAGING INFORMATION :

(1) CONFIGURATION

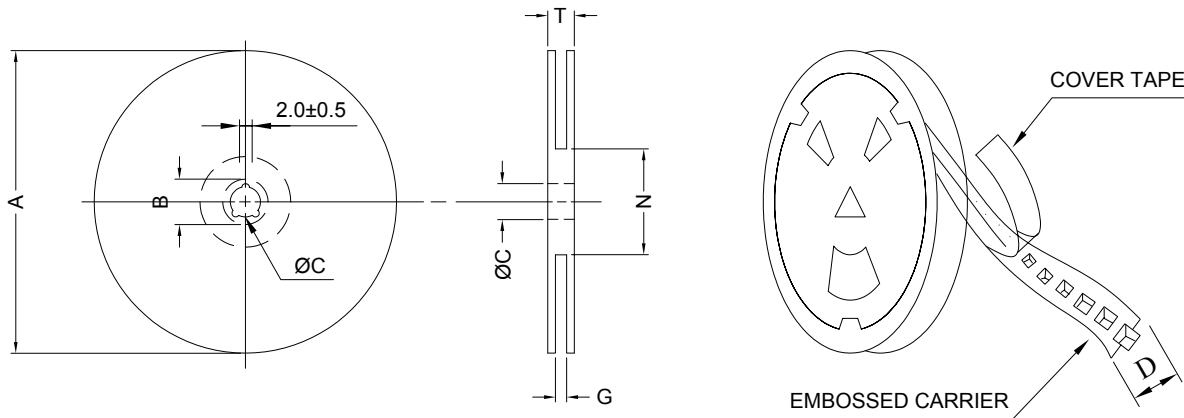

* CARRIER TAPE WIDTH : D

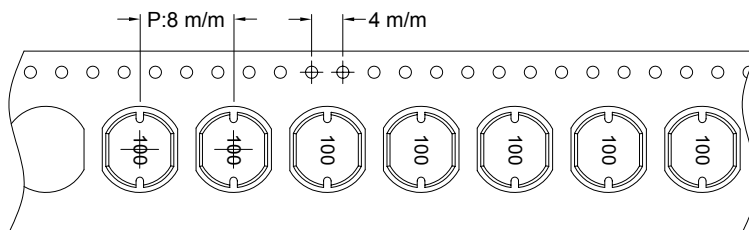

(2) DIMENSIONS

Unit:m/m

STYLE	A	B	C	D	G	N	T
13 - 12	330	21±0.8	13±0.5	12	14 ⁺⁰	50 ⁻⁰	18.4

(3) QTY & G.W. PER PACKAGE

SERIES	INNER : REEL			OUTER : CARTON		
	Q'TY (PCS)	G.W. (gw)	STYLE	Q'TY (PCS)	G.W. (Kg)	SIZE (cm)
PDC0504	1500	1180	13 - 12	12000	13.0	40 x 40 x 24



RoHS Compliant

NOTE : Specifications subject to change without notice. Please check our website for latest information.

01.05.2008



SUPERWORLD ELECTRONICS (S) PTE LTD

