



### Features

- ◇ For IF SAW filter
- ◇ High attenuation
- ◇ Single-ended operation
- ◇ No matching required for operation at 50Ω
- ◇ Dual In-line Package
- ◇ RoHS compliant (2002/95/EC), Pb-free

### Specifications

Parameter	Unit	Minimum	Typical	Maximum
Center Frequency	MHz	69.96	70	70.04
Insertion Loss	dB	-	22.5	25
1 dB Bandwidth	MHz	4.75	4.78	-
3 dB Bandwidth	MHz	-	4.94	-
40 dB Bandwidth	MHz	-	5.58	5.62
Passband Variation	dB	-	0.8	1
Absolute Delay	usec	-	3.75	-
Group Delay( $f_0 \pm 2$ MHz)	nsec	-	190	250
Ultimate Rejection	dB	40	45	-
Material Temperature coefficient	KHz/°C	-6.58		
Substrate Material	-	YZ LN		
Ambient Temperature	°C	25		
Operating Temperature Range	°C	-40	-	+85
Storage Temperature Range	°C	-45	-	+105
DC Voltage	V	0		
Input Power	dBm	-	-	10
ESD Class	-	1		
Package Size	DIP3512 (35.0x12.8x4.7mm <sup>3</sup> )			

#### Notes:

1. All specifications are based on the test circuit shown;
2. In production, all specifications are measured by Agilent Network analyzer and full 2 port calibration at room temperature;
3. Electrical margin has been built into the design to account for the variations due to temperature drift and manufacturing tolerances;
4. This is the optimum impedance in order to achieve the performance show.



**SIPAT Co., Ltd.**  
( CETC No.26 Research Institute )  
#14 Nanping Huayuan Road,  
Chongqing, China, 400060

Part Number	LBN70A47		
Rev. Date	2007-12-25		
Ver.	1.0	Page 1/3	

### Matching Configuration



Source/Load Impedance=50 ohm

Notes - Component values may change depending on board layout.

### Package Dimension

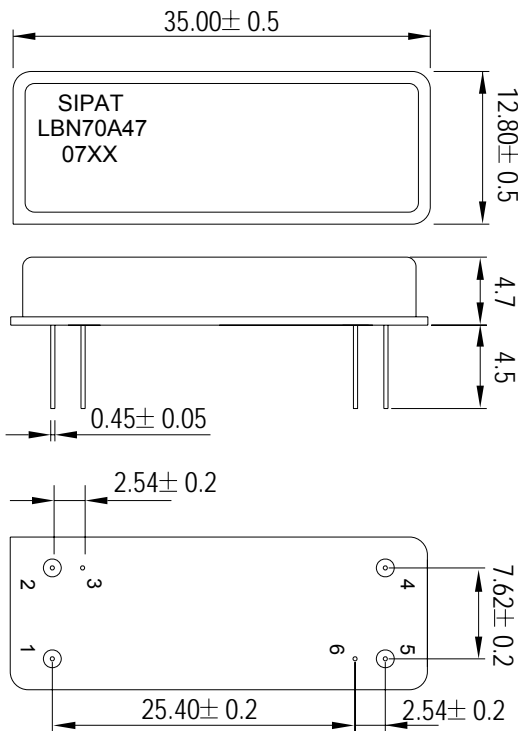

#### Pad Configuration:

Input 1  
 Output 5  
 Ground All Others

#### Marking Configuration:

- 1) SIPAT: Manufacturer Name
- 2) LBN70A47: Part Number
- 3) 07XX: Date Code

Package: DIP3512

Unit: mm



**SIPAT Co., Ltd.**  
 ( CETC No.26 Research Institute )  
 #14 Nanping Huayuan Road,  
 Chongqing, China, 400060

Part Number	LBN70A47	
Rev. Date	2007-12-25	
Ver.	1.0	Page 2/3



Typical Performance

Frequency Respond

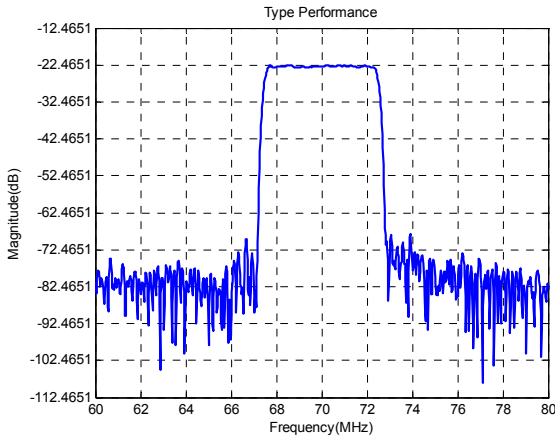

Horizontal: 2MHz/Div Vertical: 10dB/Div

Passband Respond

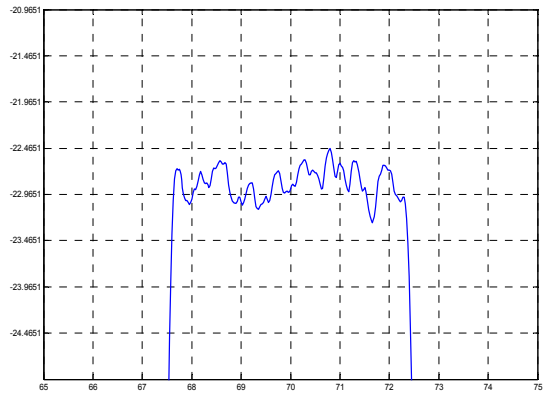

Horizontal: 1MHz/Div Vertical: 0.5dB/Div

Group Delay Variation( $f_0 \pm 2\text{MHz}$ )

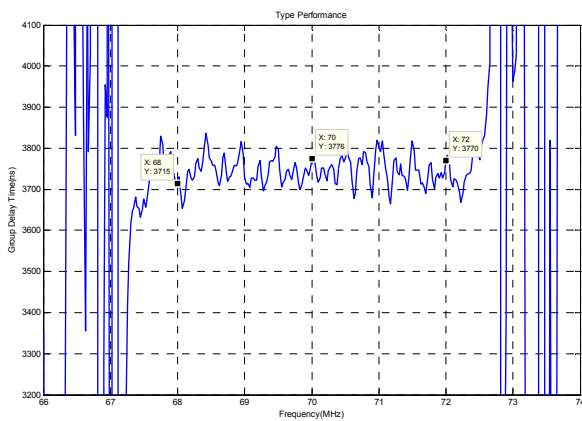

Horizontal: 1MHz/Div Vertical: 100ns/Div

Phase Linearity( $f_0 \pm 2\text{MHz}$ )

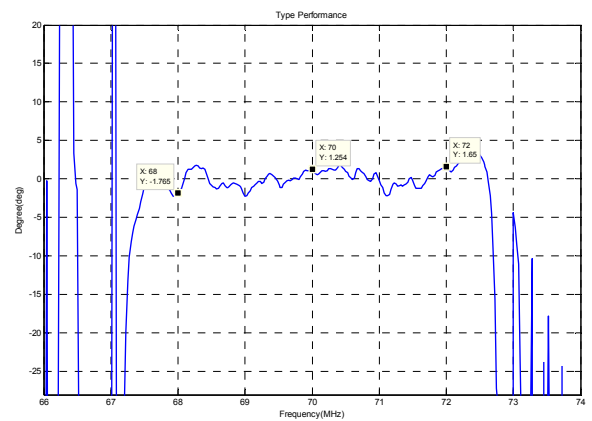

Horizontal: 1MHz/Div Vertical: 5deg/Div

Smith Chart S11

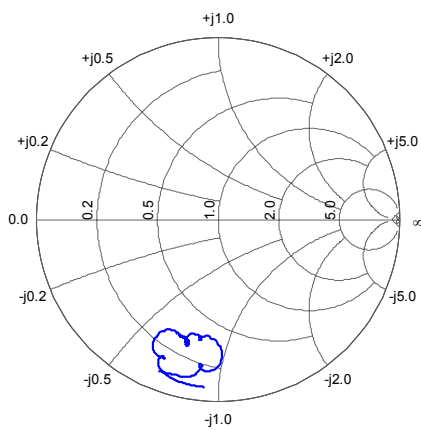

Smith Chart S22

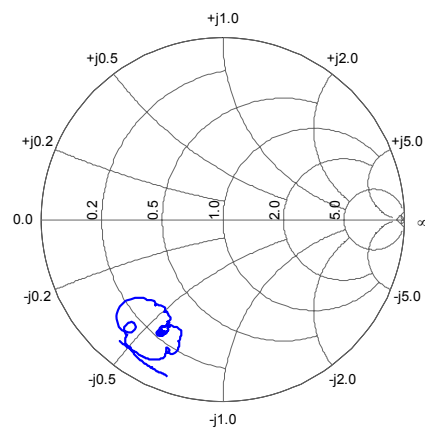

SIPAT Co., Ltd.  
( CETC No.26 Research Institute )  
#14 Nanping Huayuan Road,  
Chongqing, China, 400060

Part Number	LBN70A47	
Rev. Date	2007-12-25	
Ver.	1.0	Page 3/3