

## Features

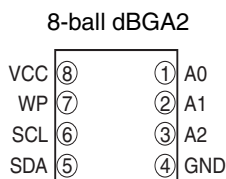
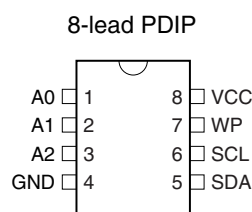
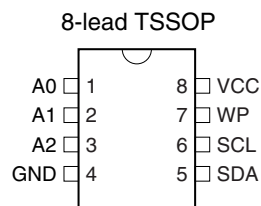
- Low-voltage and Standard-voltage Operation
  - 1.8v ( $V_{CC} = 1.8V$  to 3.6V)
  - 2.5v ( $V_{CC} = 2.5V$  to 5.5V)
- Internally Organized 65,536 x 8
- Two-wire Serial Interface
- Schmitt Triggers, Filtered Inputs for Noise Suppression
- Bidirectional Data Transfer Protocol
- 1 MHz (2.5V, 5.5V), 400 kHz (1.8V) Compatibility
- Write Protect Pin for Hardware and Software Data Protection
- 128-byte Page Write Mode (Partial Page Writes Allowed)
- Self-timed Write Cycle (5 ms Max)
- High Reliability
  - Endurance: 1,000,000 Write Cycles
  - Data Retention: 40 Years
- Lead-free/Halogen-free Devices
- 8-lead PDIP, 8-lead JEDEC SOIC, 8-lead EIAJ SOIC, 8-lead TSSOP, 8-ball dBGAA2, and 8-lead Ultra Thin Small Array (SAP) Packages
- Die Sales: Wafer Form, Waffle Pack and Bumped Die

## Description

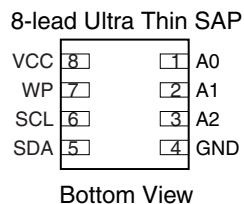
The AT24C512B provides 524,288 bits of serial electrically erasable and programmable read only memory (EEPROM) organized as 65,536 words of 8 bits each. The device's cascadable feature allows up to eight devices to share a common two-wire bus. The device is optimized for use in many industrial and commercial applications where low-power and low-voltage operation are essential. The devices are available in space-saving 8-pin PDIP, 8-lead JEDEC SOIC, 8-lead EIAJ SOIC, 8-lead TSSOP, 8-ball dBGAA2 and 8-lead Ultra Thin SAP packages. In addition, the entire family is available in 1.8V (1.8V to 3.6V) and 2.5V (2.5V to 5.5V) versions.

**Table 0-1.** Pin Configurations

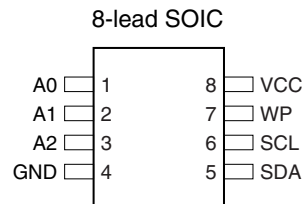
Pin Name	Function
A0–A2	Address Inputs
SDA	Serial Data
SCL	Serial Clock Input
WP	Write Protect



Bottom View



Bottom View



## Two-wire Serial EEPROM

512K (65,536 x 8)

## AT24C512B

with Three Device Address Inputs

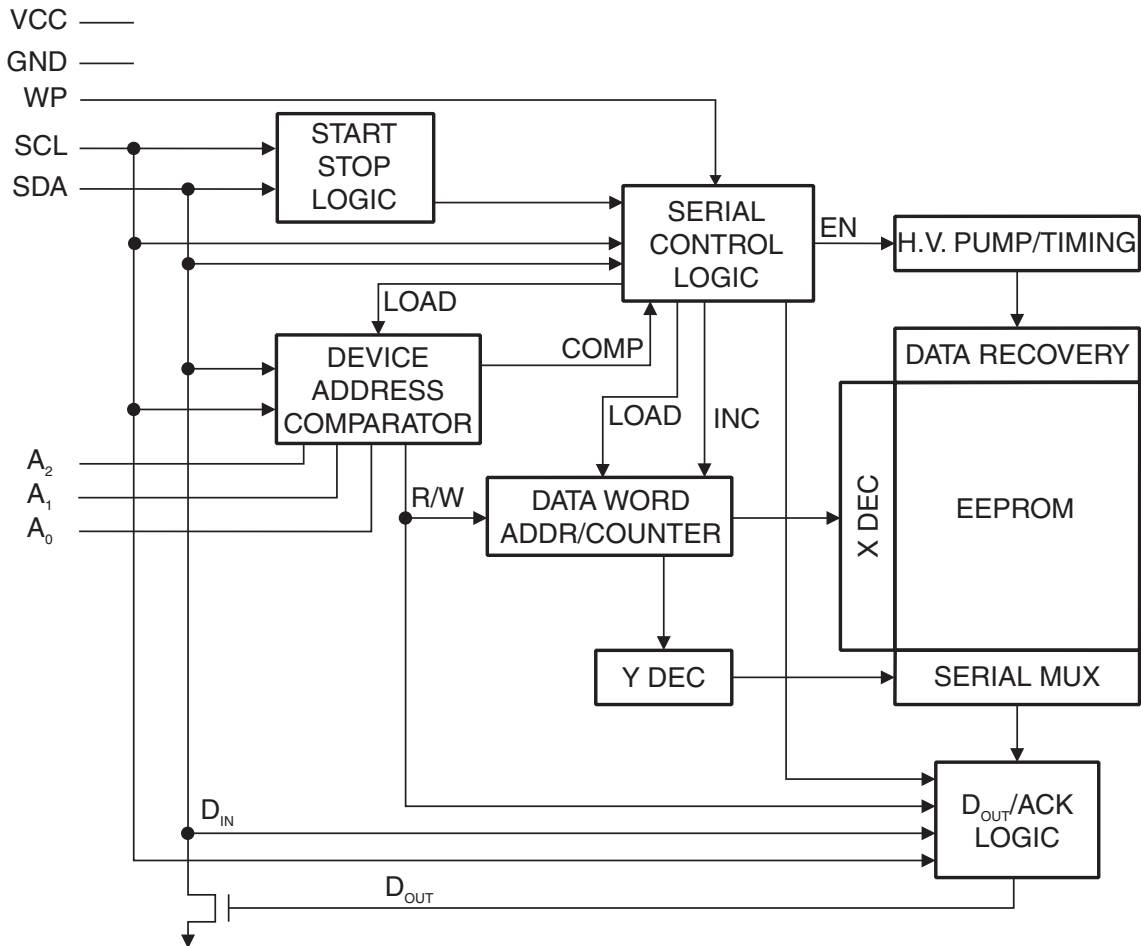


## Absolute Maximum Ratings\*

Operating Temperature .....	-55°C to +125°C
Storage Temperature .....	-65°C to +150°C
Voltage on Any Pin with Respect to Ground .....	-1.0V to +7.0V
Maximum Operating Voltage .....	6.25V
DC Output Current.....	5.0 mA

\*NOTICE: Stresses beyond those listed under “Absolute Maximum Ratings” may cause permanent damage to the device. This is a stress rating only and functional operation of the device at these or any other conditions beyond those indicated in the operational sections of this specification is not implied. Exposure to absolute maximum rating conditions for extended periods may affect device reliability.

Figure 0-1. Block Diagram



## 1. Pin Description

**SERIAL CLOCK (SCL):** The SCL input is used to positive edge clock data into each EEPROM device and negative edge clock data out of each device.

**SERIAL DATA (SDA):** The SDA pin is bidirectional for serial data transfer. This pin is open-drain driven and may be wire-ORed with any number of other open-drain or open collector devices.

**DEVICE/PAGE ADDRESSES (A2, A1, A0):** The A2, A1, and A0 pins are device address inputs that are hardwired (directly to GND or to Vcc) for compatibility with other AT24Cxx devices. When the pins are hardwired, as many as eight 512K devices may be addressed on a single bus system. (Device addressing is discussed in detail under “Device Addressing,” page 8.) A device is selected when a corresponding hardware and software match is true. If these pins are left floating, the A2, A1, and A0 pins will be internally pulled down to GND. However, due to capacitive coupling that may appear during customer applications, Atmel® recommends always connecting the address pins to a known state. When using a pull-up resistor, Atmel recommends using 10kΩ or less.

**WRITE PROTECT (WP):** The write protect input, when connected to GND, allows normal write operations. When WP is connected directly to Vcc, all write operations to the memory are inhibited. If the pin is left floating, the WP pin will be internally pulled down to GND. However, due to capacitive coupling that may appear during customer applications, Atmel recommends always connecting the WP pins to a known state. When using a pull-up resistor, Atmel recommends using 10kΩ or less.



## 2. Memory Organization

**AT24C512B, 512K SERIAL EEPROM:** The 512K is internally organized as 512 pages of 128-bytes each. Random word addressing requires a 16-bit data word address.

**Table 2-1.** Pin Capacitance<sup>(1)</sup>

Applicable over recommended operating range from:  $T_A = 25^\circ\text{C}$ ,  $f = 1.0\text{ MHz}$ ,  $V_{CC} = +1.8\text{V}$  to  $+5.5\text{V}$

Symbol	Test Condition	Max	Units	Conditions
$C_{I/O}$	Input/Output Capacitance (SDA)	8	pF	$V_{I/O} = 0\text{V}$
$C_{IN}$	Input Capacitance ( $A_0$ , $A_1$ , SCL)	6	pF	$V_{IN} = 0\text{V}$

Note: 1. This parameter is characterized and is not 100% tested.

**Table 2-2.** DC Characteristics

Applicable over recommended operating range from:  $T_{AI} = -40^\circ\text{C}$  to  $+85^\circ\text{C}$ ,  $V_{CC} = +1.8\text{V}$  to  $+5.5\text{V}$  (unless otherwise noted)

Symbol	Parameter	Test Condition		Min	Typ	Max	Units
$V_{CC1}$	Supply Voltage			1.8		3.6	V
$V_{CC2}$	Supply Voltage			2.5		5.5	V
$I_{CC}$	Supply Current	$V_{CC} = 5.0\text{V}$	READ at 400 kHz			2.0	mA
$I_{CC}$	Supply Current	$V_{CC} = 5.0\text{V}$	WRITE at 400 kHz			3.0	mA
$I_{SB1}$	Standby Current	$V_{CC} = 1.8\text{V}$	$V_{IN} = V_{CC}$ or $V_{SS}$			1.0	$\mu\text{A}$
		$V_{CC} = 3.6\text{V}$				3.0	$\mu\text{A}$
$I_{SB2}$	Standby Current	$V_{CC} = 2.5\text{V}$	$V_{IN} = V_{CC}$ or $V_{SS}$			2.0	$\mu\text{A}$
		$V_{CC} = 5.5\text{V}$				6.0	$\mu\text{A}$
$I_{LI}$	Input Leakage Current	$V_{IN} = V_{CC}$ or $V_{SS}$			0.10	3.0	$\mu\text{A}$
$I_{LO}$	Output Leakage Current	$V_{OUT} = V_{CC}$ or $V_{SS}$			0.05	3.0	$\mu\text{A}$
$V_{IL}$	Input Low Level <sup>(1)</sup>			-0.6		$V_{CC} \times 0.3$	V
$V_{IH}$	Input High Level <sup>(1)</sup>			$V_{CC} \times 0.7$		$V_{CC} + 0.5$	V
$V_{OL1}$	Output Low Level	$V_{CC} = 1.8\text{V}$	$I_{OL} = 0.15\text{ mA}$			0.2	V
$V_{OL2}$	Output Low Level	$V_{CC} = 3.0\text{V}$	$I_{OL} = 2.1\text{ mA}$			0.4	V

Note: 1.  $V_{IL}$  min and  $V_{IH}$  max are reference only and are not tested.

**Table 2-3.** AC Characteristics (Industrial Temperature)

Applicable over recommended operating range from  $T_{AI} = -40^{\circ}\text{C}$  to  $+85^{\circ}\text{C}$ ,  $V_{CC} = +1.8\text{V}$  to  $+5.5\text{V}$ ,  $CL = 100\text{ pF}$  (unless otherwise noted). Test conditions are listed in Note 2.

Symbol	Parameter	1.8-volt		2.5, 5.0-volt		Units
		Min	Max	Min	Max	
$f_{SCL}$	Clock Frequency, SCL		400		1000	kHz
$t_{LOW}$	Clock Pulse Width Low	1.3		0.4		$\mu\text{s}$
$t_{HIGH}$	Clock Pulse Width High	0.6		0.4		$\mu\text{s}$
$t_i$	Noise Suppression Time <sup>(1)</sup>		100		50	ns
$t_{AA}$	Clock Low to Data Out Valid	0.05	0.9	0.05	0.55	$\mu\text{s}$
$t_{BUF}$	Time the bus must be free before a new transmission can start <sup>(1)</sup>	1.3		0.5		$\mu\text{s}$
$t_{HD,STA}$	Start Hold Time	0.6		0.25		$\mu\text{s}$
$t_{SU,STA}$	Start Set-up Time	0.6		0.25		$\mu\text{s}$
$t_{HD,DAT}$	Data In Hold Time	0		0		$\mu\text{s}$
$t_{SU,DAT}$	Data In Set-up Time	100		100		ns
$t_R$	Inputs Rise Time <sup>(1)</sup>		0.3		0.3	$\mu\text{s}$
$t_F$	Inputs Fall Time <sup>(1)</sup>		300		100	ns
$t_{SU,STO}$	Stop Set-up Time	0.6		0.25		$\mu\text{s}$
$t_{DH}$	Data Out Hold Time	50		50		ns
$t_{WR}$	Write Cycle Time		5		5	ms
Endurance <sup>(1)</sup>	25°C, Page Mode, 3.3V	1,000,000				Write Cycles

Notes: 1. This parameter is ensured by characterization only.

2. AC measurement conditions:

$R_L$  (connects to  $V_{CC}$ ): 1.3 k $\Omega$  (2.5V, 5V), 10 k $\Omega$  (1.8V)

Input pulse voltages: 0.3  $V_{CC}$  to 0.7  $V_{CC}$

Input rise and fall times:  $\leq 50\text{ ns}$

Input and output timing reference voltages: 0.5  $V_{CC}$

### 3. Device Operation

**CLOCK and DATA TRANSITIONS:** The SDA pin is normally pulled high with an external device. Data on the SDA pin may change only during SCL low time periods (see [Figure 3-4 on page 8](#)). Data changes during SCL high periods will indicate a start or stop condition as defined below.

**START CONDITION:** A high-to-low transition of SDA with SCL high is a start condition which must precede any other command (see [Figure 3-5 on page 8](#)).

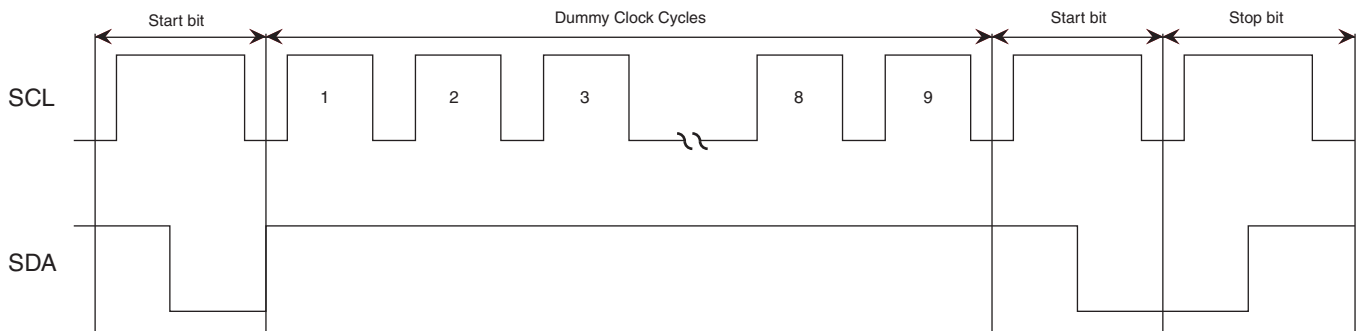
**STOP CONDITION:** A low-to-high transition of SDA with SCL high is a stop condition. After a read sequence, the stop command will place the EEPROM in a standby power mode (see [Figure 3-5 on page 8](#)).

**ACKNOWLEDGE:** All addresses and data words are serially transmitted to and from the EEPROM in 8-bit words. The EEPROM sends a zero during the ninth clock cycle to acknowledge that it has received each word.

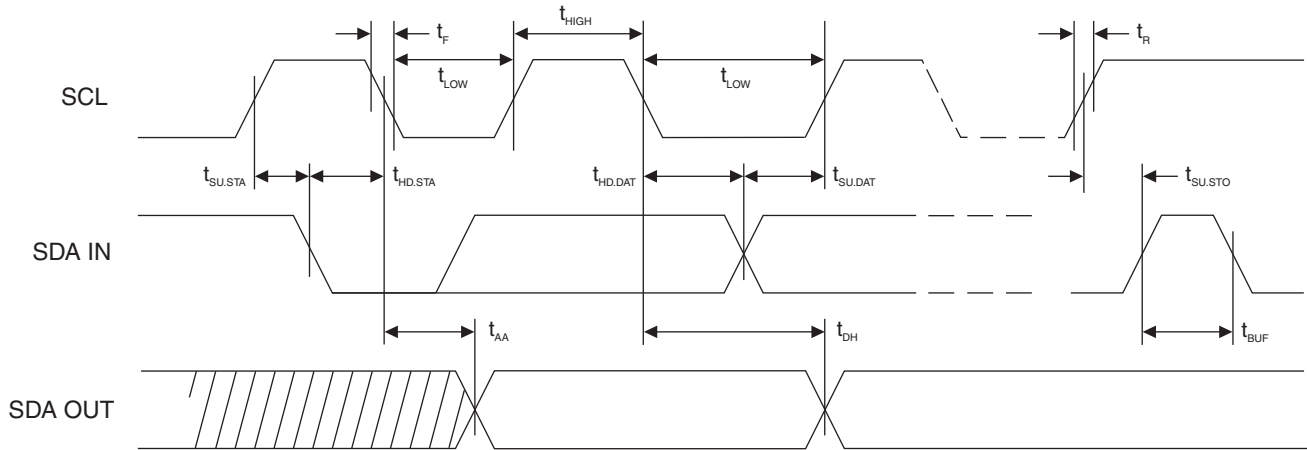
**STANDBY MODE:** The AT24C512B features a low power standby mode which is enabled: a) upon power-up and b) after the receipt of the STOP bit and the completion of any internal operations.

**Software Reset:** After an interruption in protocol, power loss or system reset, any 2-wire part can be protocol reset by following these steps: (a) Create a start bit condition, (b) clock 9 cycles, (c) create another start bit followed by stop bit condition as shown below. The device is ready for next communication after above steps have been completed.

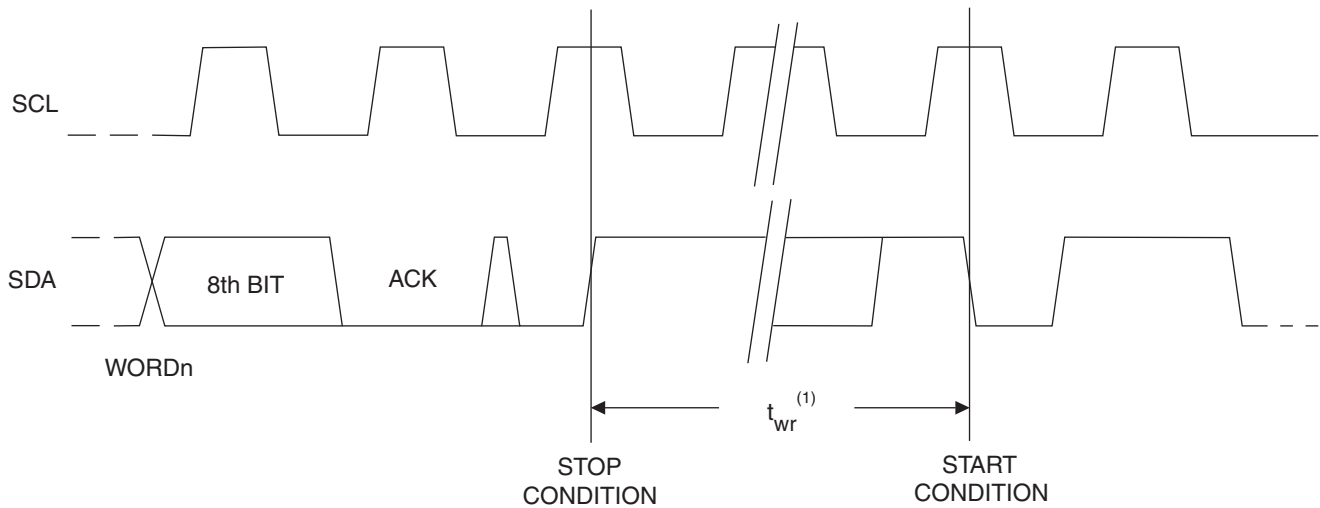
**Figure 3-1. Protocol Reset Condition**



**Figure 3-2.** Bus Timing (SCL: Serial Clock, SDA: Serial Data I/O)

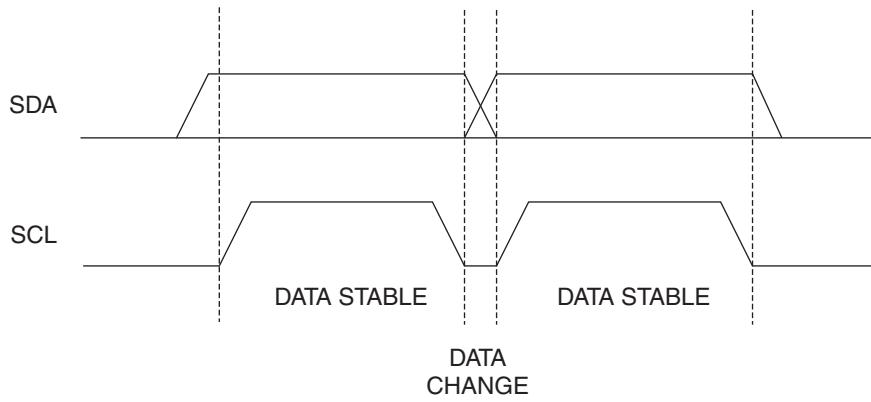


**Figure 3-3.** Write Cycle Timing (SCL: Serial Clock, SDA: Serial Data I/O)

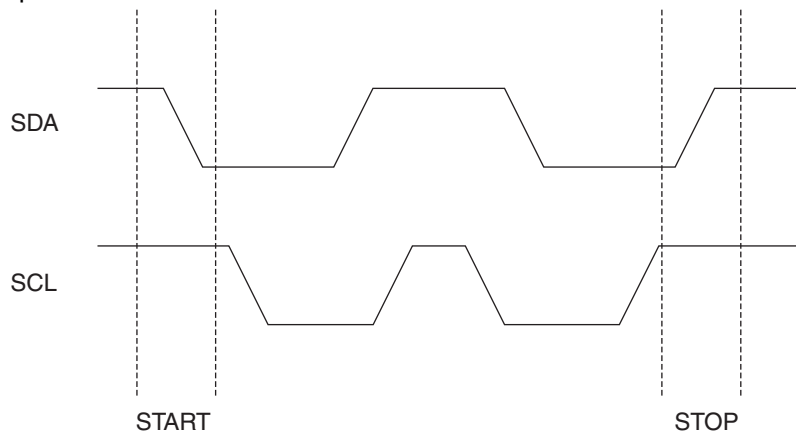


Note: 1. The write cycle time  $t_{WR}$  is the time from a valid stop condition of a write sequence to the end of the internal clear/write cycle.

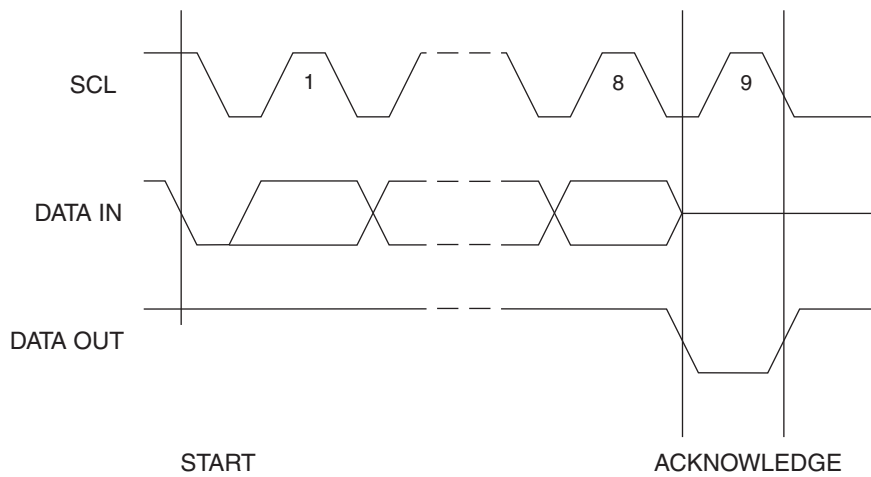
**Figure 3-4.** Data Validity



**Figure 3-5.** Start and Stop Definition



**Figure 3-6.** Output Acknowledge





## 4. Device Addressing

The 512K EEPROM requires an 8-bit device address word following a start condition to enable the chip for a read or write operation (see [Figure 6-1 on page 10](#)). The device address word consists of a mandatory “1”, “0” sequence for the first four most significant bits as shown. This is common to all two-wire EEPROM devices.

The 512K uses the three device address bits A2, A1, A0 to allow as many as eight devices on the same bus. These bits must compare to their corresponding hardwired input pins. The A2, A1 and A0 pins use an internal proprietary circuit that biases them to a logic low condition if the pins are allowed to float.

The eighth bit of the device address is the read/write operation select bit. A read operation is initiated if this bit is high and a write operation is initiated if this bit is low.

Upon a compare of the device address, the EEPROM will output a “0”. If a compare is not made, the device will return to a standby state.

**DATA SECURITY:** The AT24C512B has a hardware data protection scheme that allows the user to Write Protect the whole memory when the WP pin is at  $V_{CC}$ .

## 5. Write Operations

**BYTE WRITE:** A write operation requires two 8-bit data word addresses following the device address word and acknowledgment. Upon receipt of this address, the EEPROM will again respond with a “0” and then clock in the first 8-bit data word. Following receipt of the 8-bit data word, the EEPROM will output a “0”. The addressing device, such as a microcontroller, then must terminate the write sequence with a stop condition. At this time the EEPROM enters an internally-timed write cycle,  $t_{WR}$ , to the nonvolatile memory. All inputs are disabled during this write cycle and the EEPROM will not respond until the write is complete (see [Figure 6-2 on page 10](#)).

**PAGE WRITE:** The 512K EEPROM is capable of 128-byte page writes.

A page write is initiated the same way as a byte write, but the microcontroller does not send a stop condition after the first data word is clocked in. Instead, after the EEPROM acknowledges receipt of the first data word, the microcontroller can transmit up to 127 more data words. The EEPROM will respond with a “0” after each data word received. The microcontroller must terminate the page write sequence with a stop condition (see [Figure 6-3 on page 11](#)).

The data word address lower 7 bits are internally incremented following the receipt of each data word. The higher data word address bits are not incremented, retaining the memory page row location. When the word address, internally generated, reaches the page boundary, the following byte is placed at the beginning of the same page. If more than 128 data words are transmitted to the EEPROM, the data word address will “roll over” and previous data will be overwritten. The address roll over during write is from the last byte of the current page to the first byte of the same page.

**ACKNOWLEDGE POLLING:** Once the internally-timed write cycle has started and the EEPROM inputs are disabled, acknowledge polling can be initiated. This involves sending a start condition followed by the device address word. The Read/Write bit is representative of the operation desired. Only if the internal write cycle has completed will the EEPROM respond with a “0”, allowing the read or write sequence to continue.

## 6. Read Operations

Read operations are initiated the same way as write operations with the exception that the Read/Write select bit in the device address word is set to “1”. There are three read operations: current address read, random address read and sequential read.

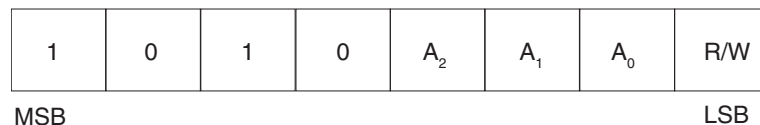
**CURRENT ADDRESS READ:** The internal data word address counter maintains the last address accessed during the last read or write operation, incremented by “1”. This address stays valid between operations as long as the chip power is maintained. The address roll over during read is from the last byte of the last memory page, to the first byte of the first page.

Once the device address with the Read/Write select bit set to “1” is clocked in and acknowledged by the EEPROM, the current address data word is serially clocked out. The microcontroller does not respond with an input “0” but does generate a following stop condition (see [Figure 6-4 on page 11](#)).

**RANDOM READ:** A random read requires a “dummy” byte write sequence to load in the data word address. Once the device address word and data word address are clocked in and acknowledged by the EEPROM, the microcontroller must generate another start condition. The microcontroller now initiates a current address read by sending a device address with the Read/Write select bit high. The EEPROM acknowledges the device address and serially clocks out the data word. The microcontroller does not respond with a “0” but does generate a following stop condition (see [Figure 6-5 on page 11](#)).

**SEQUENTIAL READ:** Sequential reads are initiated by either a current address read or a random address read. After the microcontroller receives a data word, it responds with an acknowledge. As long as the EEPROM receives an acknowledge, it will continue to increment the data word address and serially clock out sequential data words. When the memory address limit is reached, the data word address will roll over and the sequential read will continue. The sequential read operation is terminated when the microcontroller does not respond with a “0” but does generate a following stop condition (see [Figure 6-6 on page 11](#)).

**Figure 6-1.** Device Address



**Figure 6-2.** Byte Write

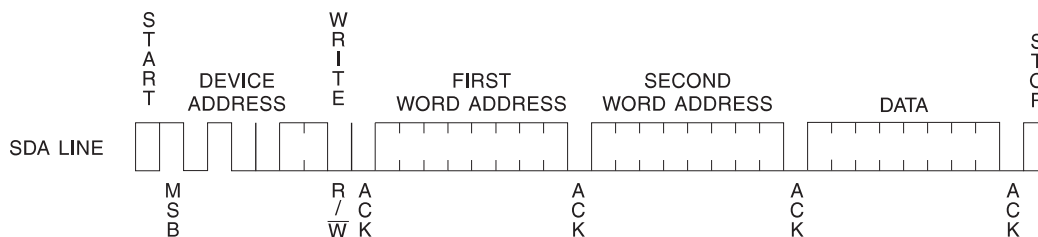


Figure 6-3. Page Write

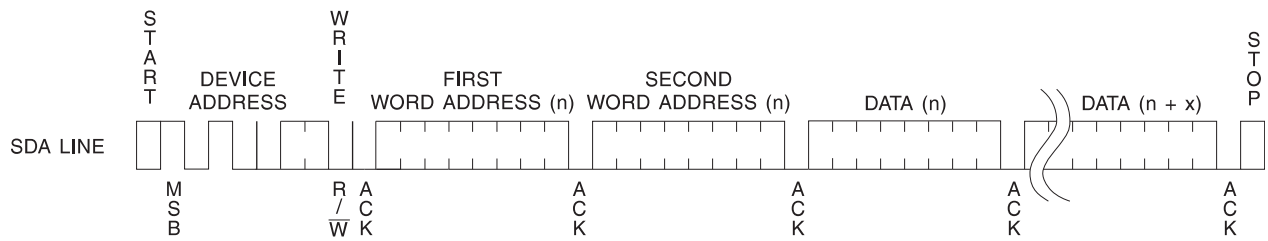


Figure 6-4. Current Address Read

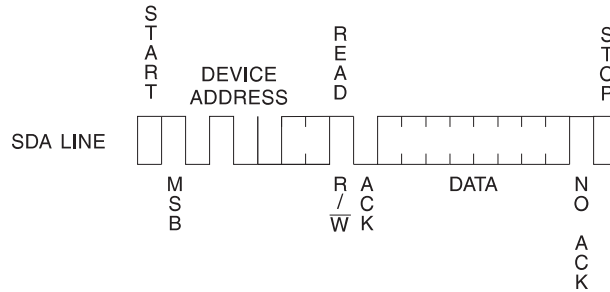


Figure 6-5. Random Read

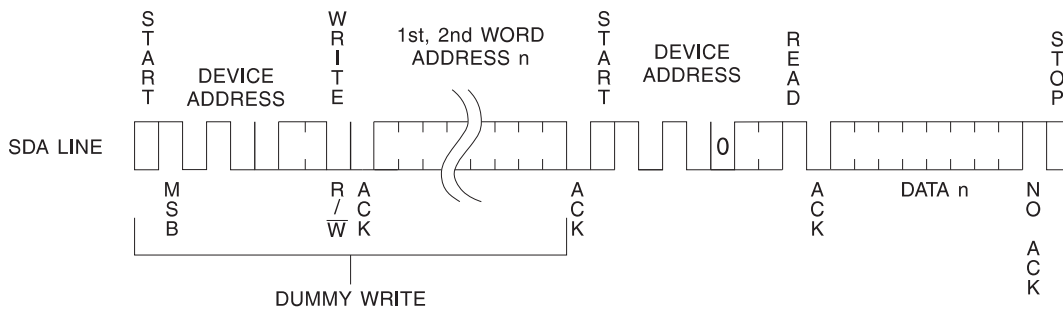
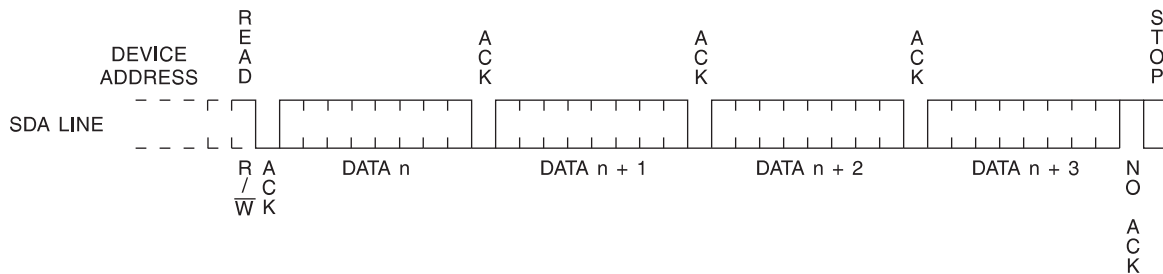


Figure 6-6. Sequential Read





## Ordering Information

Ordering Code	Voltage	Package	Operation Range
AT24C512B-PU (Bulk form only)	1.8	8P3	Lead-free/Halogen-free/ Industrial Temperature (-40°C to 85°C)
AT24C512B-PU25 (Bulk form only)	2.5	8P3	
AT24C512BN-SH-B <sup>(1)</sup> (NiPdAu Lead Finish)	1.8	8S1	
AT24C512BN-SH-T <sup>(2)</sup> (NiPdAu Lead Finish)	1.8	8S1	
AT24C512BN-SH25-B <sup>(1)</sup> (NiPdAu Lead Finish)	2.5	8S1	
AT24C512BN-SH25-T <sup>(2)</sup> (NiPdAu Lead Finish)	2.5	8S1	
AT24C512BW-SH-B <sup>(1)</sup> (NiPdAu Lead Finish)	1.8	8S2	
AT24C512BW-SH-T <sup>(2)</sup> (NiPdAu Lead Finish)	1.8	8S2	
AT24C512BW-SH25-B <sup>(1)</sup> (NiPdAu Lead Finish)	2.5	8S2	
AT24C512BW-SH25-T <sup>(2)</sup> (NiPdAu Lead Finish)	2.5	8S2	
AT24C512B-TH-B <sup>(1)</sup> (NiPdAu Lead Finish)	1.8	8A2	
AT24C512B-TH-T <sup>(2)</sup> (NiPdAu Lead Finish)	1.8	8A2	
AT24C512B-TH25-B <sup>(1)</sup> (NiPdAu Lead Finish)	2.5	8A2	
AT24C512B-TH25-T <sup>(2)</sup> (NiPdAu Lead Finish)	2.5	8A2	
AT24C512BY7-YH-T <sup>(2)</sup> (NiPdAu Lead Finish)	1.8	8Y7	
AT24C512BY7-YH25-T <sup>(2)</sup> (NiPdAu Lead Finish)	2.5	8Y7	
AT24C512BU2-UU-T <sup>(2)</sup>	1.8	8U2-1	Industrial Temperature (-40°C to 85°C)
AT24C512B-W-11 <sup>(3)</sup>	1.8	Die Sale	

- Notes:
1. “-B” denotes bulk
  2. “-T” denotes tape and reel. SOIC = 4K per reel. TSSOP and dBGAA2 = 5K per reel. SAP = 3K per reel. EIAJ = 2K per reel.
  3. Available in tape and reel, and wafer form; order as SL788 for inkless wafer form. Bumped die available upon request. Please contact Serial Interface Marketing.

Package Type	
<b>8P3</b>	8-lead, 0.300" Wide, Plastic Dual In-line Package (PDIP)
<b>8S1</b>	8-lead, 0.150" Wide, Plastic Gull Wing Small Outline Package (JEDEC SOIC)
<b>8S2</b>	8-lead, 0.200" Wide Plastic Gull Wing Small Outline Package (EIAJ SOIC)
<b>8A2</b>	8-lead, 4.4 mm Body, Plastic Thin Shrink Small Outline Package (TSSOP)
<b>8Y7</b>	8-lead, 6.00 mm x 4.90 mm Body, Ultra Thin, Dual Footprint, Non-leaded, Small Array Package (SAP)
<b>8U2-1</b>	8-ball, die Ball Grid Array Package (dBGAA2)
Options	
<b>-1.8</b>	Low-voltage (1.8V to 3.6V)
<b>-2.5</b>	Low-voltage (2.5V to 5.5V)

## 7. Part marking scheme:

### 7.1 8-PDIP(1.8V)

**TOP MARK**

								Seal Year		
								Seal Week		
---	---	---	---	---	---	---	---			
A	T	M	L	U	Y	W	W			
---	---	---	---	---	---	---	---			
2	F	B		1						
---	---	---	---	---	---	---	---			
*	Lot Number									
---	---	---	---	---	---	---	---			

Pin 1 Indicator (Dot)

Y = SEAL YEAR		WW = SEAL WEEK	
6: 2006	0: 2010	02 =	Week 2
7: 2007	1: 2011	04 =	Week 4
8: 2008	2: 2012	:: : :	::: : :
9: 2009	3: 2013	:: : :	::: : ::
		50 =	Week 50
		52 =	Week 52

Lot Number to Use ALL Characters in Marking

**BOTTOM MARK**

No Bottom Mark

### 7.2 8-PDIP(2.5V)

**TOP MARK**

								Seal Year		
								Seal Week		
---	---	---	---	---	---	---	---			
A	T	M	L	U	Y	W	W			
---	---	---	---	---	---	---	---			
2	F	B		2						
---	---	---	---	---	---	---	---			
*	Lot Number									
---	---	---	---	---	---	---	---			

Pin 1 Indicator (Dot)

Y = SEAL YEAR		WW = SEAL WEEK	
6: 2006	0: 2010	02 =	Week 2
7: 2007	1: 2011	04 =	Week 4
8: 2008	2: 2012	:: : :	::: : :
9: 2009	3: 2013	:: : :	::: : ::
		50 =	Week 50
		52 =	Week 52

Lot Number to Use ALL Characters in Marking

**BOTTOM MARK**

No Bottom Mark



### 7.3 8-SOIC(1.8V)

**TOP MARK**

				Seal Year			Seal Week	
A	T	M	L	H	Y	W	W	
2	F	B					1	
* Lot Number								
Pin 1 Indicator (Dot)								

Y = SEAL YEAR		WW = SEAL WEEK	
6: 2006	0: 2010	02 =	Week 2
7: 2007	1: 2011	04 =	Week 4
8: 2008	2: 2012	:: : :::: :	
9: 2009	3: 2013	:: : :::: ::	
		50 =	Week 50
		52 =	Week 52

Lot Number to Use ALL Characters in Marking

**BOTTOM MARK**

No Bottom Mark

### 7.4 8-SOIC(2.5V)

**TOP MARK**

				Seal Year			Seal Week	
A	T	M	L	H	Y	W	W	
2	F	B					2	
* Lot Number								
Pin 1 Indicator (Dot)								

Y = SEAL YEAR		WW = SEAL WEEK	
6: 2006	0: 2010	02 =	Week 2
7: 2007	1: 2011	04 =	Week 4
8: 2008	2: 2012	:: : :::: :	
9: 2009	3: 2013	:: : :::: ::	
		50 =	Week 50
		52 =	Week 52

Lot Number to Use ALL Characters in Marking

**BOTTOM MARK**

No Bottom Mark

7.5 8-TSSOP(1.8V)

TOP MARK

```

    Pin 1 Indicator (Dot)
    |
    |---|---|---|---|
    *  H  Y  W  W
    |---|---|---|---|
    2  F  B  1  *
    |---|---|---|---|
  
```

Y = SEAL YEAR

6:	2006	0:	2010
7:	2007	1:	2011
8:	2008	2:	2012
9:	2009	3:	2013

WW = SEAL WEEK

02 =	Week 2
04 =	Week 4
:: :	:::: :
:: :	:::: ::
50 =	Week 50
52 =	Week 52

BOTTOM MARK

```

    |---|---|---|---|---|---|---|
    C  0  0
    |---|---|---|---|---|---|
    A  A  A  A  A  A  A
    |---|---|---|---|---|---|
    <- Pin 1 Indicator
  
```

Country of origin

7.6 8-TSSOP(2.5V)

TOP MARK

```

    Pin 1 Indicator (Dot)
    |
    |---|---|---|---|
    *  H  Y  W  W
    |---|---|---|---|
    2  F  B  2  *
    |---|---|---|---|
  
```

Y = SEAL YEAR

6:	2006	0:	2010
7:	2007	1:	2011
8:	2008	2:	2012
9:	2009	3:	2013

WW = SEAL WEEK

02 =	Week 2
04 =	Week 4
:: :	:::: :
:: :	:::: ::
50 =	Week 50
52 =	Week 52

BOTTOM MARK

```

    |---|---|---|---|---|---|---|
    C  0  0
    |---|---|---|---|---|---|
    A  A  A  A  A  A  A
    |---|---|---|---|---|---|
    <- Pin 1 Indicator
  
```

Country of origin

## 7.7 8-Ultra Thin SAP (1.8V)

TOP MARK	Seal Year	Y = SEAL YEAR	WW = SEAL WEEK
	Seal Week	6: 2006    0: 2010	02 = Week 2
		7: 2007    1: 2011	04 = Week 4
--- --- --- --- --- --- --- ---		8: 2008    2: 2012	:: : :::: :
A  T  M  L  H  Y  W  W		9: 2009    3: 2013	:: : :::: ::
--- --- --- --- --- --- --- ---			50 = Week 50
2  F  B          1			52 = Week 52
--- --- --- --- --- --- --- ---			
Lot Number			
--- --- --- --- --- --- --- ---			
*			
Pin 1 Indicator (Dot)			

## 7.8 8-Ultra Thin SAP (2.5V)

TOP MARK	Seal Year	Y = SEAL YEAR	WW = SEAL WEEK
	Seal Week	6: 2006    0: 2010	02 = Week 2
		7: 2007    1: 2011	04 = Week 4
--- --- --- --- --- --- --- ---		8: 2008    2: 2012	:: : :::: :
A  T  M  L  H  Y  W  W		9: 2009    3: 2013	:: : :::: ::
--- --- --- --- --- --- --- ---			50 = Week 50
2  F  B          2			52 = Week 52
--- --- --- --- --- --- --- ---			
Lot Number			
--- --- --- --- --- --- --- ---			
*			
Pin 1 Indicator (Dot)			



## 7.8 dBGA2

TOP MARK

```
LINE 1----->    2FBU
LINE 2----->    YMTC
                   |<-- Pin 1 This Corner
```

P = Country of Origin

Y = ONE DIGIT YEAR CODE

4: 2004 7: 2007

5: 2005 8: 2008

6: 2006 9: 2009

M = SEAL MONTH (USE ALPHA DESIGNATOR A-L)

A = JANUARY

B = FEBRUARY

" " " " " " " " " " " "

J = OCTOBER

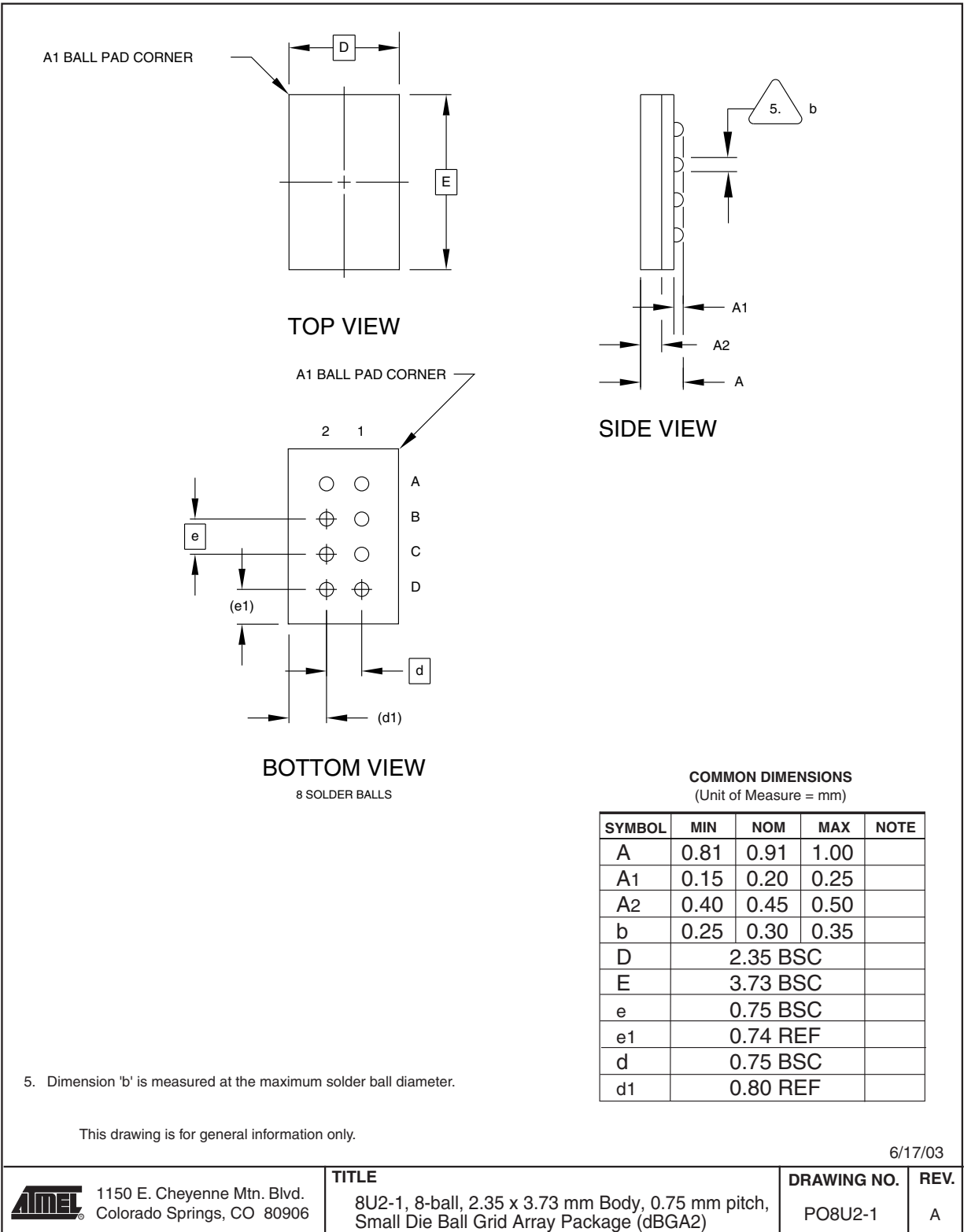
K = NOVEMBER

L = DECEMBER

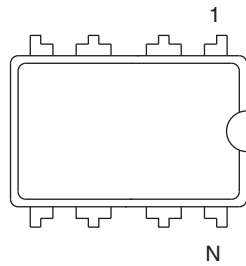
TC = TRACE CODE (ATMEL LOT  
NUMBERS TO CORRESPOND  
WITH ATK TRACE CODE LOG BOOK)

## 8. Package Information

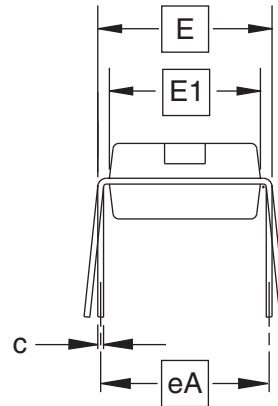
### U2-1 - dBGA2



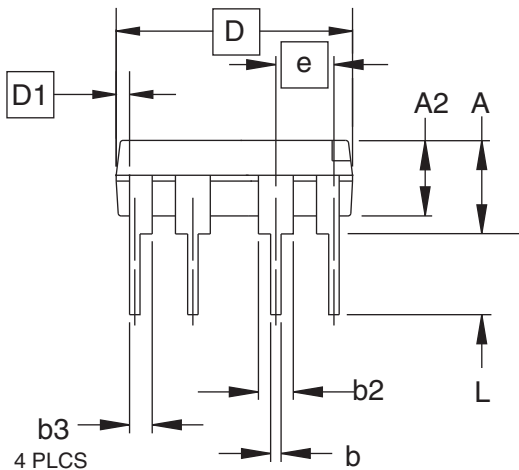
8P3 – PDIP



Top View



End View



Side View

COMMON DIMENSIONS  
(Unit of Measure = inches)

SYMBOL	MIN	NOM	MAX	NOTE
A	–	–	0.210	2
A2	0.115	0.130	0.195	
b	0.014	0.018	0.022	5
b2	0.045	0.060	0.070	6
b3	0.030	0.039	0.045	6
c	0.008	0.010	0.014	
D	0.355	0.365	0.400	3
D1	0.005	–	–	3
E	0.300	0.310	0.325	4
E1	0.240	0.250	0.280	3
e	0.100 BSC			
eA	0.300 BSC			4
L	0.115	0.130	0.150	2

- Notes:
1. This drawing is for general information only; refer to JEDEC Drawing MS-001, Variation BA, for additional information.
  2. Dimensions A and L are measured with the package seated in JEDEC seating plane Gauge GS-3.
  3. D, D1 and E1 dimensions do not include mold Flash or protrusions. Mold Flash or protrusions shall not exceed 0.010 inch.
  4. E and eA measured with the leads constrained to be perpendicular to datum.
  5. Pointed or rounded lead tips are preferred to ease insertion.
  6. b2 and b3 maximum dimensions do not include Dambar protrusions. Dambar protrusions shall not exceed 0.010 (0.25 mm).

01/09/02

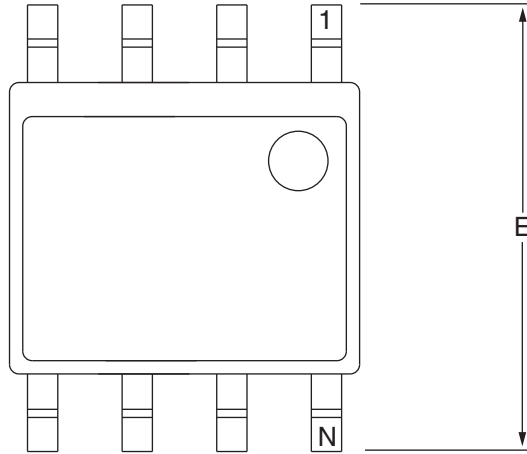
**ATMEL** 2325 Orchard Parkway  
San Jose, CA 95131

**TITLE**  
8P3, 8-lead, 0.300" Wide Body, Plastic Dual  
In-line Package (PDIP)

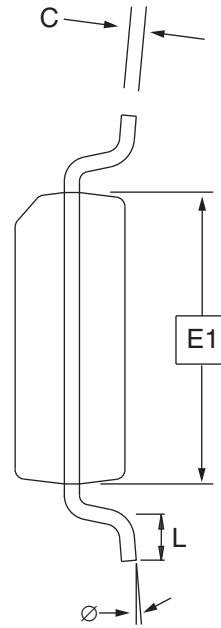
**DRAWING NO.**  
8P3

**REV.**  
B

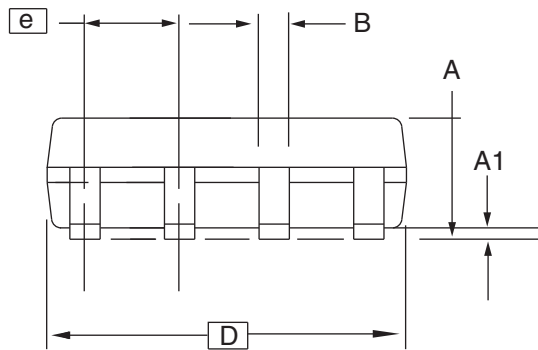
# 8S1 – JEDEC SOIC



Top View



End View



Side View

**COMMON DIMENSIONS**  
(Unit of Measure = mm)

SYMBOL	MIN	NOM	MAX	NOTE
A	1.35	–	1.75	
A1	0.10	–	0.25	
B	0.31	–	0.51	
C	0.17	–	0.25	
D	4.80	–	5.00	
E1	3.81	–	3.99	
E	5.79	–	6.20	
e	1.27 BSC			
L	0.40	–	1.27	
Ø	0°	–	8°	

Note: These drawings are for general information only. Refer to JEDEC Drawing MS-012, Variation AA for proper dimensions, tolerances, datums, etc.

10/7/03



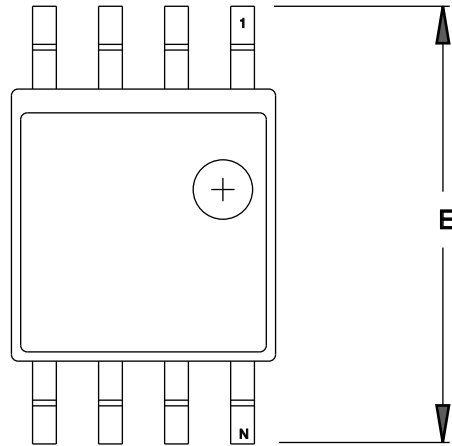
1150 E. Cheyenne Mtn. Blvd.  
Colorado Springs, CO 80906

**TITLE**  
8S1, 8-lead (0.150" Wide Body), Plastic Gull Wing  
Small Outline (JEDEC SOIC)

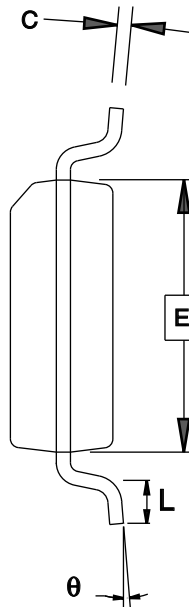
**DRAWING NO.**  
8S1

**REV.**  
B

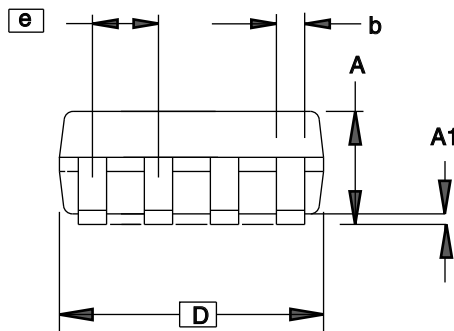
8S2 - EIAJ SOIC



TOP VIEW



END VIEW



SIDE VIEW

COMMON DIMENSIONS  
(Unit of Measure = mm)

SYMBOL	MIN	NOM	MAX	NOTE
A	1.70		2.16	
A1	0.05		0.25	
b	0.35		0.48	5
C	0.15		0.35	5
D	5.13		5.35	
E1	5.18		5.40	2, 3
E	7.70		8.26	
L	0.51		0.85	
$\theta$	0°		8°	
e	1.27 BSC			4

- Notes: 1. This drawing is for general information only; refer to EIAJ Drawing EDR-7320 for additional information.  
 2. Mismatch of the upper and lower dies and resin burrs aren't included.  
 3. It is recommended that upper and lower cavities be equal. If they are different, the larger dimension shall be regarded.  
 4. Determines the true geometric position.  
 5. Values b,C apply to plated terminal. The standard thickness of the plating layer shall measure between 0.007 to .021 mm.

4/7/06



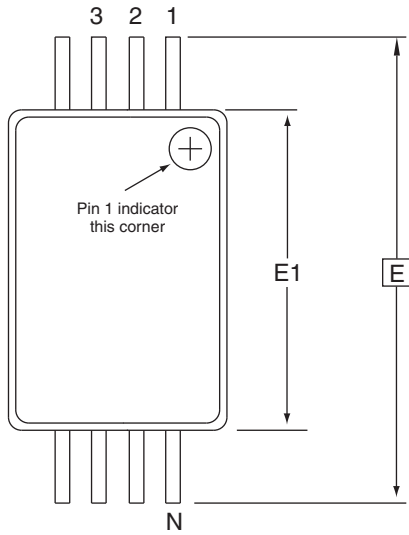
2325 Orchard Parkway  
San Jose, CA 95131

**TITLE**  
8S2, 8-lead, 0.209" Body, Plastic Small  
Outline Package (EIAJ)

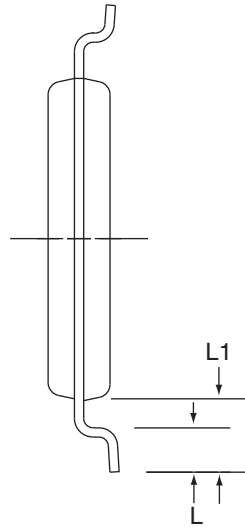
<b>DRAWING NO.</b> 8S2	<b>REV.</b> D
---------------------------	------------------



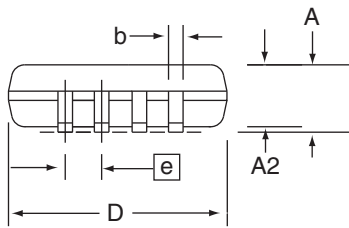
# 8A2 – TSSOP



Top View



End View



Side View

**COMMON DIMENSIONS**  
(Unit of Measure = mm)

SYMBOL	MIN	NOM	MAX	NOTE
D	2.90	3.00	3.10	2, 5
E	6.40 BSC			
E1	4.30	4.40	4.50	3, 5
A	–	–	1.20	
A2	0.80	1.00	1.05	
b	0.19	–	0.30	4
e	0.65 BSC			
L	0.45	0.60	0.75	
L1	1.00 REF			

- Notes:
1. This drawing is for general information only. Refer to JEDEC Drawing MO-153, Variation AA, for proper dimensions, tolerances, datums, etc.
  2. Dimension D does not include mold Flash, protrusions or gate burrs. Mold Flash, protrusions and gate burrs shall not exceed 0.15 mm (0.006 in) per side.
  3. Dimension E1 does not include inter-lead Flash or protrusions. Inter-lead Flash and protrusions shall not exceed 0.25 mm (0.010 in) per side.
  4. Dimension b does not include Dambar protrusion. Allowable Dambar protrusion shall be 0.08 mm total in excess of the b dimension at maximum material condition. Dambar cannot be located on the lower radius of the foot. Minimum space between protrusion and adjacent lead is 0.07 mm.
  5. Dimension D and E1 to be determined at Datum Plane H.

5/30/02

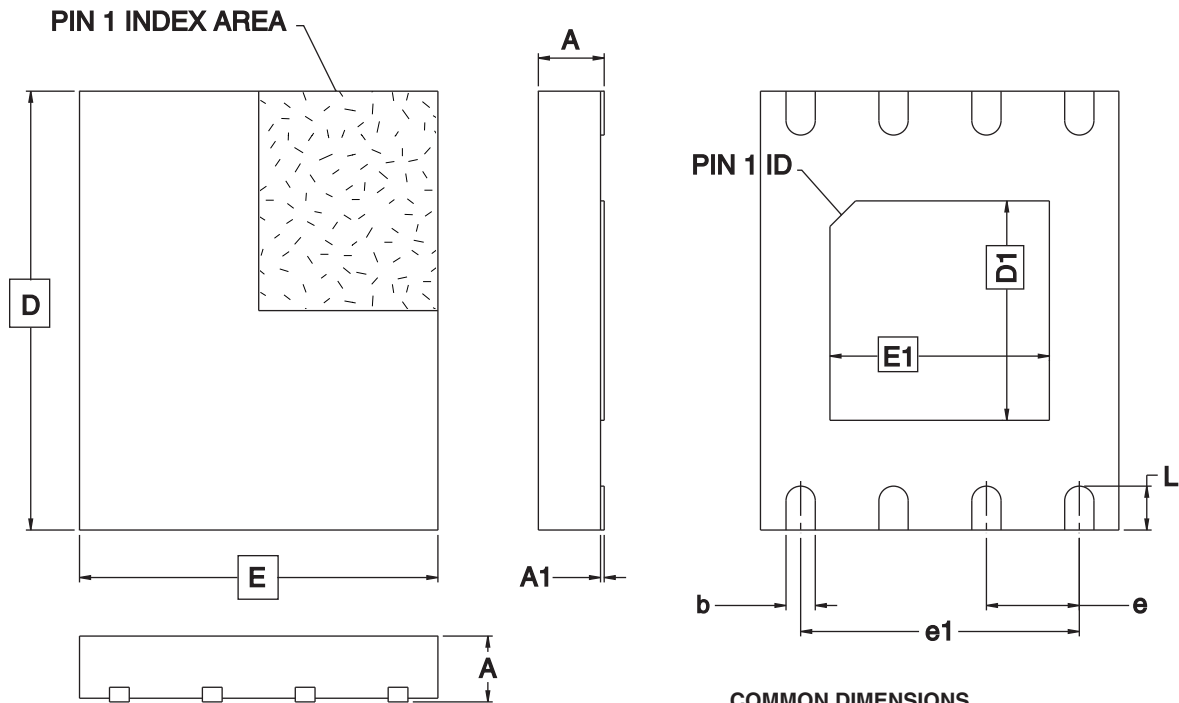
2325 Orchard Parkway  
San Jose, CA 95131

**TITLE**  
**8A2**, 8-lead, 4.4 mm Body, Plastic  
Thin Shrink Small Outline Package (TSSOP)

**DRAWING NO.**  
8A2

**REV.**  
B

8Y7 – UTSAP



COMMON DIMENSIONS  
(Unit of Measure = mm)

SYMBOL	MIN	NOM	MAX	NOTE
A	–	–	0.60	
A1	0.00	–	0.05	
D	5.80	6.00	6.20	
E	4.70	4.90	5.10	
D1	3.30	3.40	3.50	
E1	3.90	4.00	4.10	
b	0.35	0.40	0.45	
e	1.27 TYP			
e1	3.81 REF			
L	0.50	0.60	0.70	

10/13/05



1150 E. Cheyenne Mtn. Blvd.  
Colorado Springs, CO 80906

TITLE

8Y7, 8-lead (6.00 x 4.90 mm Body) Ultra-Thin SOIC Array  
Package (UTSAP) Y7

DRAWING NO.

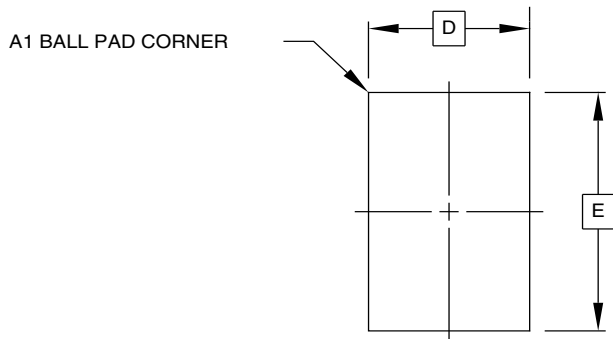
8Y7

REV.

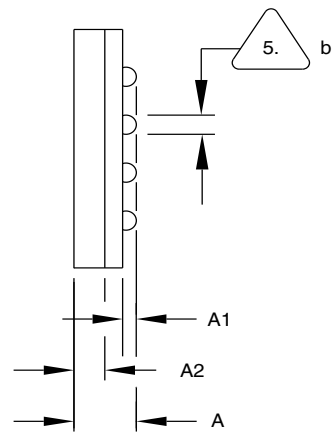
B



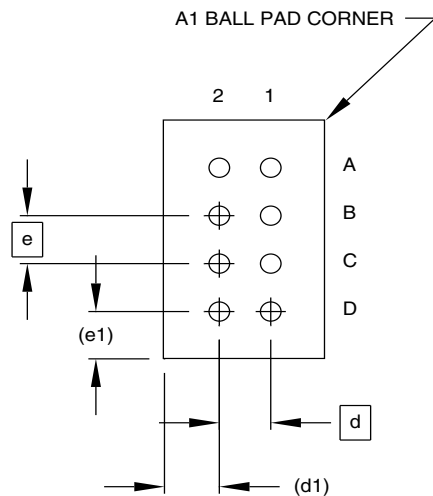
# 8U2-1 – dBGA2



TOP VIEW



SIDE VIEW



BOTTOM VIEW

8 SOLDER BALLS

COMMON DIMENSIONS  
(Unit of Measure = mm)

SYMBOL	MIN	NOM	MAX	NOTE
A	0.81	0.91	1.00	
A1	0.15	0.20	0.25	
A2	0.40	0.45	0.50	
b	0.25	0.30	0.35	
D	2.35 BSC			
E	3.73 BSC			
e	0.75 BSC			
e1	0.74 REF			
d	0.75 BSC			
d1	0.80 REF			

5. Dimension 'b' is measured at the maximum solder ball diameter.

This drawing is for general information only.

6/17/03



1150 E. Cheyenne Mtn. Blvd.  
Colorado Springs, CO 80906

TITLE

8U2-1, 8-ball, 2.35 x 3.73 mm Body, 0.75 mm pitch,  
Small Die Ball Grid Array Package (dBGA2)

DRAWING NO.

PO8U2-1

REV.

A



## Revision History

Doc. Rev.	Date	Comments
5297A	1/2008	AT24C512B product with date code 2008 work week 14 (814) or later supports 5Vcc operation Initial document release



## Headquarters

---

**Atmel Corporation**  
2325 Orchard Parkway  
San Jose, CA 95131  
USA  
Tel: 1(408) 441-0311  
Fax: 1(408) 487-2600

## International

---

**Atmel Asia**  
Room 1219  
Chinachem Golden Plaza  
77 Mody Road Tsimshatsui  
East Kowloon  
Hong Kong  
Tel: (852) 2721-9778  
Fax: (852) 2722-1369

**Atmel Europe**  
Le Krebs  
8, Rue Jean-Pierre Timbaud  
BP 309  
78054 Saint-Quentin-en-  
Yvelines Cedex  
France  
Tel: (33) 1-30-60-70-00  
Fax: (33) 1-30-60-71-11

**Atmel Japan**  
9F, Tonetsu Shinkawa Bldg.  
1-24-8 Shinkawa  
Chuo-ku, Tokyo 104-0033  
Japan  
Tel: (81) 3-3523-3551  
Fax: (81) 3-3523-7581

## Product Contact

---

**Web Site**  
[www.atmel.com](http://www.atmel.com)

**Technical Support**  
[s\\_eeeprom@atmel.com](mailto:s_eeeprom@atmel.com)

**Sales Contact**  
[www.atmel.com/contacts](http://www.atmel.com/contacts)

**Literature Requests**  
[www.atmel.com/literature](http://www.atmel.com/literature)

---

**Disclaimer:** The information in this document is provided in connection with Atmel products. No license, express or implied, by estoppel or otherwise, to any intellectual property right is granted by this document or in connection with the sale of Atmel products. **EXCEPT AS SET FORTH IN ATMEL'S TERMS AND CONDITIONS OF SALE LOCATED ON ATMEL'S WEB SITE, ATMEL ASSUMES NO LIABILITY WHATSOEVER AND DISCLAIMS ANY EXPRESS, IMPLIED OR STATUTORY WARRANTY RELATING TO ITS PRODUCTS INCLUDING, BUT NOT LIMITED TO, THE IMPLIED WARRANTY OF MERCHANTABILITY, FITNESS FOR A PARTICULAR PURPOSE, OR NON-INFRINGEMENT. IN NO EVENT SHALL ATMEL BE LIABLE FOR ANY DIRECT, INDIRECT, CONSEQUENTIAL, PUNITIVE, SPECIAL OR INCIDENTAL DAMAGES (INCLUDING, WITHOUT LIMITATION, DAMAGES FOR LOSS OF PROFITS, BUSINESS INTERRUPTION, OR LOSS OF INFORMATION) ARISING OUT OF THE USE OR INABILITY TO USE THIS DOCUMENT, EVEN IF ATMEL HAS BEEN ADVISED OF THE POSSIBILITY OF SUCH DAMAGES.** Atmel makes no representations or warranties with respect to the accuracy or completeness of the contents of this document and reserves the right to make changes to specifications and product descriptions at any time without notice. Atmel does not make any commitment to update the information contained herein. Unless specifically provided otherwise, Atmel products are not suitable for, and shall not be used in, automotive applications. Atmel's products are not intended, authorized, or warranted for use as components in applications intended to support or sustain life.

©2008 Atmel Corporation. **All rights reserved.** Atmel<sup>®</sup>, logo and combinations thereof, and others, are registered trademarks or trademarks of Atmel Corporation or its subsidiaries. Other terms and product names may be trademarks of others.