



Parameter	Ratings	Units
Blocking Voltage	800	$V_P$
Load Current	250	$mA_{rms}$
On State Voltage Drop	3	$V_{rms}$ (at $I_L = 250 mA_{rms}$ )
Operating Voltage	550	$V_{rms}$

## Features

- Load Current up to  $250mA_{rms}$
- $800V_P$  Blocking Voltage
- 5mA Sensitivity
- Zero-Crossing Detection
- DC Control, AC Output
- Optically Isolated
- TTL and CMOS Compatible
- Low EMI and RFI Generation
- High Noise Immunity
- Machine Insertable, Wave Solderable
- Flammability classification rating of V-0

## Applications

- Programmable Control
- Process Control
- Power Control Panels
- Remote Switching
- Gas Pump Electronics
- Contactors
- Large Relays
- Solenoids
- Motors
- Heaters

## Description

The CPC1972 is an AC Solid State Switch using optical coupling with dual power Silicon Controlled Rectifier (SCR) outputs to produce an alternative to optocoupler and Triac circuits. The CPC1972 switches are robust enough to provide a blocking voltage of up to  $800V_P$ . In addition, tightly controlled zero cross circuitry ensures switching of AC loads without the generation of transients. The input and output circuits are optically coupled to provide  $3750V_{rms}$  of isolation and noise immunity between the control and load circuits. As a result the CPC1972 is well suited for industrial environments where electromagnetic interference could disrupt the operation of electromechanical relays.

## Approvals

- UL 508 Recognized Component: File #: E69938
- CSA Certified Component: Certificate # 1172007
- EN/IEC 60950 Compliant

## Ordering Information

Part Number	Description
CPC1972G	6-Pin DIP (50/Tube)
CPC1972GS	6-Pin Surface Mount (50/Tube)
CPC1972GSTR	6-Pin Surface Mount (1000/Reel)

## Pin Configuration

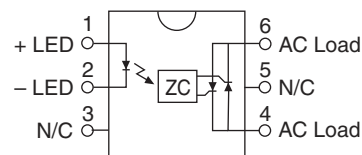

## Absolute Maximum Ratings

Parameter	Ratings	Units
Blocking Voltage	800	$V_P$
Reverse Input Voltage	5	V
Input Control Current	50	mA
Peak (10ms)	1	A
Input Power Dissipation <sup>1</sup>	150	mW
Total Package Dissipation <sup>2</sup>	800	mW
Isolation Voltage Input to Output	3750	$V_{rms}$
Operational Temperature	-40 to +85	°C
Storage Temperature	-40 to +125	°C

<sup>1</sup> Derate Linearly 1.33 mW/°C

<sup>2</sup> Derate Linearly 6.67 mW/°C

Electrical absolute maximum ratings are at 25°C

*Absolute Maximum Ratings are stress ratings. Stresses in excess of these ratings can cause permanent damage to the device. Functional operation of the device at conditions beyond those indicated in the operational sections of this data sheet is not implied.*

## Electrical Characteristics

Parameters	Conditions	Symbol	Min	Typ	Max	Units
<b>Output Characteristics @ 25°C</b>						
Operating Voltage Range	-	$V_L$	5	-	550	$V_{rms}$
Load Current						
Continuous	-	$I_L$	5	-	250	$mA_{rms}$
Peak	t = 10ms	$I_{TSM}$	-	-	2	$A_P$
Off State Leakage Current	$V_L=800V$	$I_{LEAK}$	-	-	1	$\mu A$
On-State Voltage Drop	$I_L = 250mA_{rms}$	$V_{ON}$	-	-	3	$V_{rms}$
Critical Rate of Rise	-	dV/dt	500	-	-	V/ $\mu s$
Holding Current	$I_F=5mA$	$I_H$	-	300	-	$\mu A$
Switching Speeds						
Turn-on	$I_F=5mA$	$t_{ON}$	-	-	0.5	cycles
Turn-off		$t_{OFF}$	-	-	0.5	
Zero-Cross Turn-On Voltage <sup>1</sup>	1st half-cycle	-	-	5	20	V
	Subsequent half-cycle	-	-	1	-	V
Operating Frequency	-	-	20	-	500	Hz
Load Power Factor for Guaranteed Turn-On <sup>2</sup>	f=60Hz	PF	0.25	-	-	-
<b>Input Characteristics @ 25°C</b>						
Input Control Current <sup>3</sup>	-	$I_F$	-	-	5	mA
Input Voltage Drop	$I_F=5mA$	$V_F$	0.9	1.2	1.4	V
Input Drop-out Voltage	-	-	0.8	-	-	V
Reverse Input Current	$V_R=5V$	$I_R$	-	-	10	$\mu A$
<b>Common Characteristics @ 25°C</b>						
Input to Output Capacitance	-	$C_{IO}$	-	3	-	pF

<sup>1</sup> Zero Cross 1st half-cycle @ <100Hz

<sup>2</sup> Snubber circuits may be required at low power factors.

<sup>3</sup> For high noise environment use at least 10mA LED current

**PERFORMANCE DATA \***

**Typical LED Forward Voltage Drop**  
( $T_A=25^\circ\text{C}$ ,  $I_F=5\text{mA}$ )

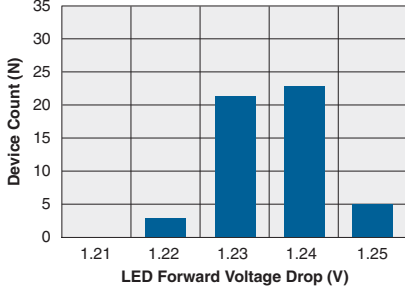

**Typical On-State Output Forward Voltage Distribution**  
( $T_A=25^\circ\text{C}$ )

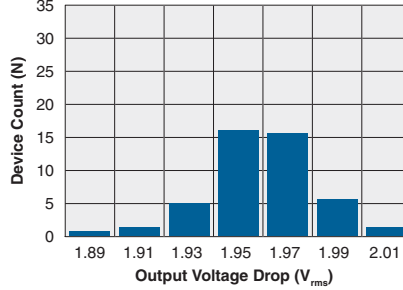

**Typical Blocking Voltage Distribution**  
( $T_A=25^\circ\text{C}$ )

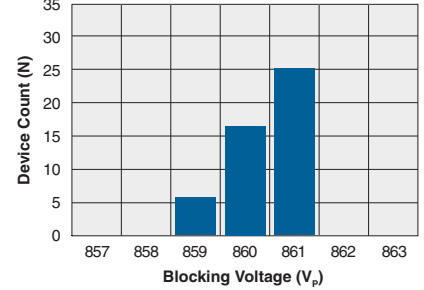

**Typical  $I_F$  for Switch Operation**  
( $T_A=25^\circ\text{C}$ )

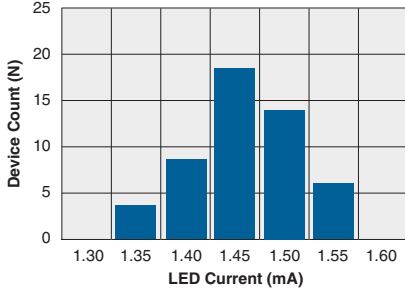

**Typical Maximum Load Current vs. Temperature**

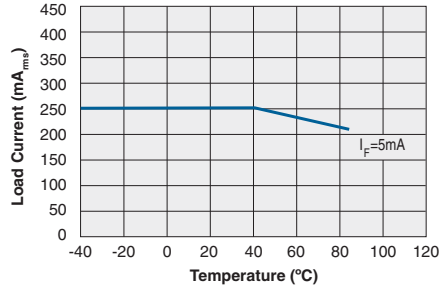

**Typical Leakage vs. Temperature**  
( $V_L=800V_p$ )

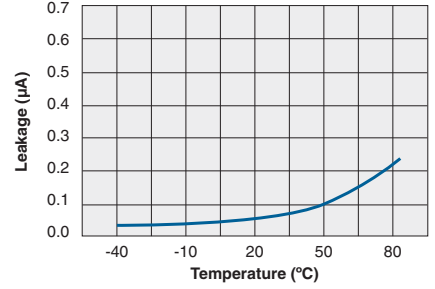

**Typical Blocking Voltage vs. Temperature**

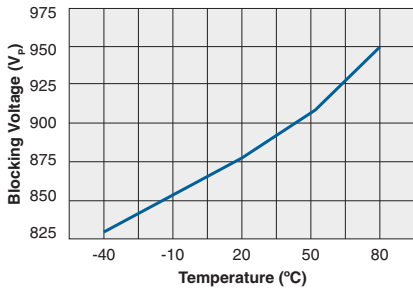

**Typical Output Voltage Drop vs. Temperature**

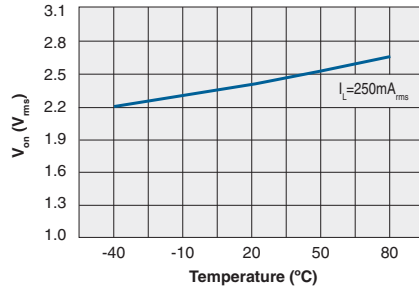

**Typical LED Forward Voltage Drop vs. Temperature**

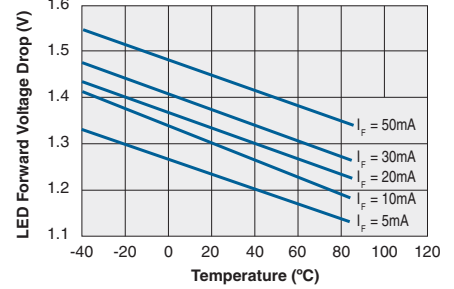

**Typical  $I_F$  for Switch Operation vs. Temperature**

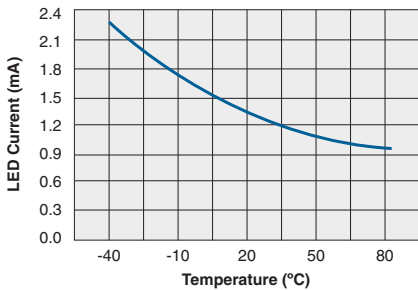

**Maximum Surge Current (non-repetitive)**  
( $T_J=50^\circ\text{C}$  max)

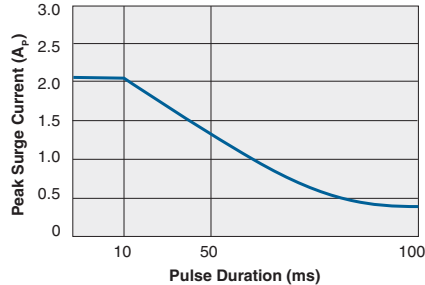

\*The Performance data shown in the graphs above is typical of device performance. For guaranteed parameters not indicated in the written specifications, please contact our application department.

**Manufacturing Information**

**Soldering**

For proper assembly, the component must be processed in accordance with the current revision of IPC/JEDEC standard J-STD-020. Failure to follow the recommended guidelines may cause permanent damage to the device resulting in impaired performance and/or a reduced lifetime expectancy.

**Washing**

Clare does not recommend ultrasonic cleaning or the use of chlorinated solvents.



**MECHANICAL DIMENSIONS**

**6-Pin DIP Thru-Hole Package**

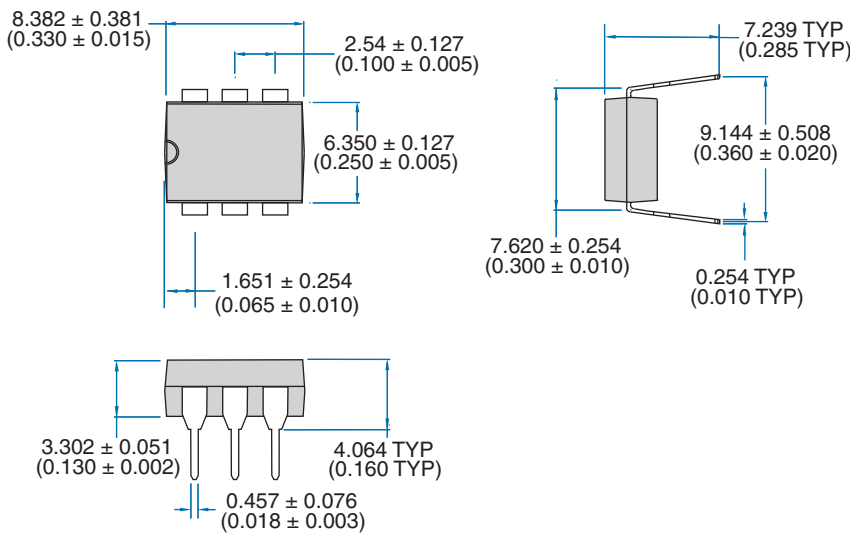

**PC Board Pattern**

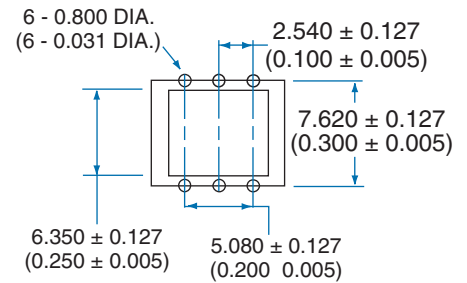

Dimensions  
mm  
(inches)

**6-Pin Surface Mount Package ("S" Suffix)**

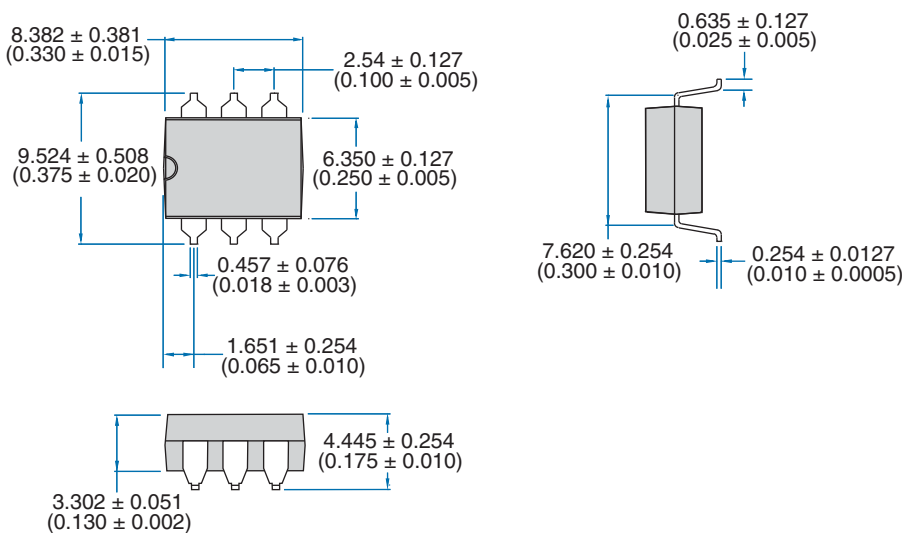

**Recommended PCB Land Pattern**

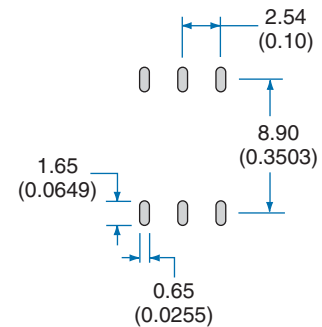

Dimensions  
mm  
(inches)

**Tape and Reel Packaging for 6-Pin “S” Suffix Parts**

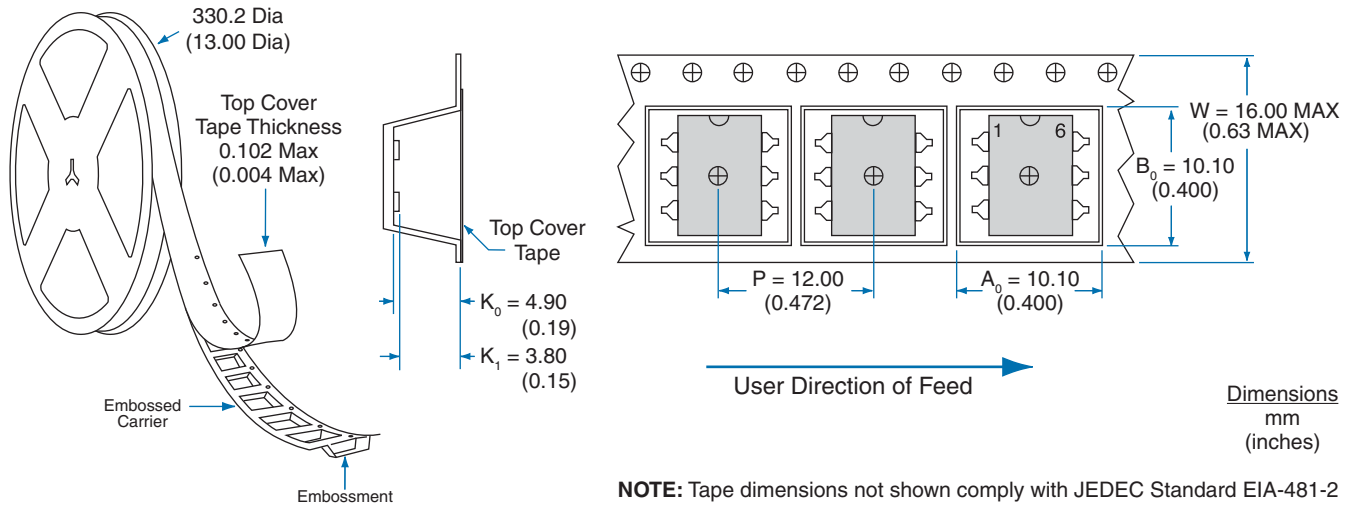

**For additional information please visit our website at: [www.clare.com](http://www.clare.com)**

Clare, Inc. makes no representations or warranties with respect to the accuracy or completeness of the contents of this publication and reserves the right to make changes to specifications and product descriptions at any time without notice. Neither circuit patent licenses nor indemnity are expressed or implied. Except as set forth in Clare's Standard Terms and Conditions of Sale, Clare, Inc. assumes no liability whatsoever, and disclaims any express or implied warranty, relating to its products including, but not limited to, the implied warranty of merchantability, fitness for a particular purpose, or infringement of any intellectual property right.

The products described in this document are not designed, intended, authorized or warranted for use as components in systems intended for surgical implant into the body, or in other applications intended to support or sustain life, or where malfunction of Clare's product may result in direct physical harm, injury, or death to a person or severe property or environmental damage. Clare, Inc. reserves the right to discontinue or make changes to its products at any time without notice.

Specification: DS-CPC1972-R03  
©Copyright 2009, Clare, Inc.  
All rights reserved. Printed in USA.  
7/20/09