

DATA SHEET

NEC

GaAs INTEGRATED CIRCUIT μ PG2053K

GaAs MMIC DBS 4 x 2 IF SWITCH MATRIX

FEATURES

- HIGH ISOLATION : ISL = 38 dB TYP. @ f = 0.95 to 2.15 GHz, $V_{CONT} = +5.0$ V/0 V
- CONTROL VOLTAGE : $V_{CONT(H)} = +4.5$ to $+5.5$ V (+5.0 V TYP.)
: $V_{CONT(L)} = -0.5$ to $+0.5$ V (0 V TYP.)
- LOW INSERTION LOSS : $L_{INS} = 6.0$ dB TYP. @ f = 0.95 to 2.15 GHz, $V_{CONT} = +5.0$ V/0 V, $Z_0 = 50 \Omega$
- 20-PIN 4 x 4 mm SQUARE MICRO LEAD PACKAGE (20-pin plastic QFN (0.5 mm pitch))

APPLICATIONS

- Direct Broadcast Satellite (DBS)
- Switch Box
- 4 x 2 switch matrix to L, S band applications

ORDERING INFORMATION

Part Number	Package	Marking	Supplying Form
μ PG2053K-E3	20-pin plastic QFN (0.5 mm pitch)	G2053	<ul style="list-style-type: none">• Embossed tape 12 mm wide• Pin 1 to 5 face the perforation side of the tape• Qty 3 kpcs/reel

Remark To order evaluation samples, contact your nearby sales office.

Part number for sample order: μ PG2053K

Caution Observe precautions when handling because these devices are sensitive to electrostatic discharge.

The information in this document is subject to change without notice. Before using this document, please confirm that this is the latest version.
Not all devices/types available in every country. Please check with local NEC Compound Semiconductor Devices representative for availability and additional information.

ABSOLUTE MAXIMUM RATINGS (T_A = +25°C, unless otherwise specified)

Parameter	Symbol	Ratings	Unit
Supply Voltage	V _{DD}	-1.0 to +6.0	V
Control Voltage	V _{CONT1 to 4}	-1.0 to +6.0	V
Total Power Dissipation	P _{tot}	2 ^{Note}	W
Input Power	P _{in}	+10	dBm
Operating Ambient Temperature	T _A	-40 to +85	°C
Storage Temperature	T _{stg}	-65 to +150	°C

Note Mounted on double-sided copper-clad 50 × 50 × 1.6 mm epoxy glass PWB, T_A = +85°C

RECOMMENDED OPERATING CONDITIONS (T_A = +25°C)

Parameter	Symbol	MIN.	TYP.	MAX.	Unit
Supply Voltage	V _{DD}	+4.5	+5.0	+5.5	V
Control Voltage (H)	V _{CONT (H)}	+4.5	+5.0	+5.5	V
Control Voltage (L)	V _{CONT (L)}	-0.5	0	+0.5	V

ELECTRICAL CHARACTERISTICS

(T_A = +25°C, V_{DD} = +5.0 V, V_{CONT} = +5.0 V/0 V, P_{in} = 0 dBm, Z_o = 50 Ω, each port, unless otherwise specified)

Parameter	Symbol	Test Conditions	MIN.	TYP.	MAX.	Unit
Insertion Loss	L _{INS}	f = 0.95 to 2.15 GHz	-	6.0	8.0	dB
Insertion Loss Flatness	ΔL _{INS}	L _{INS (0.95 GHz)} - L _{INS (2.15 GHz)}	-	0.5	1.5	dB
Isolation D/U-ratio ^{Note 1}	ISL	f = 0.95 to 2.15 GHz	35	38	-	dB
Output Return Loss	RL _{out}	f = 0.95 to 2.15 GHz	10	15	-	dB
Control Current ^{Note 2}	I _{CONT}	V _{CONT} = +5.0 V/0 V, non-RF	-	-	0.5	mA
Supply Current	I _{DD}	V _{CONT} = +5.0 V/0 V, non-RF	-	-	2.0	mA

Notes 1. Isolation D/U-ratio = |(Signal leakage (off-state)) - (Insertion loss (on-state))|

2. Per 1 control pin

PIN CONNECTIONS

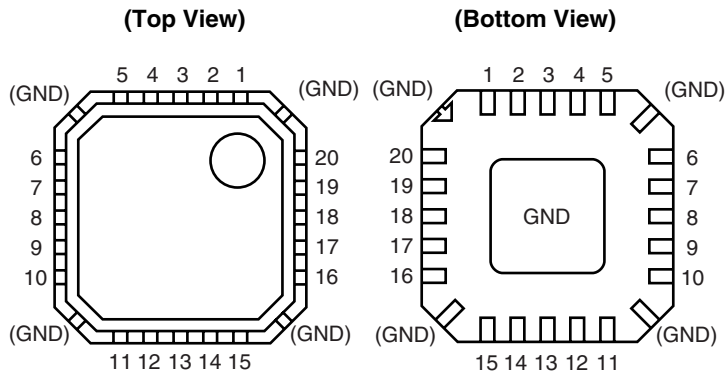

Pin No.	Pin Name	Pin No.	Pin Name
1	V _{CONT1}	11	V _{CONT4}
2	N.C.	12	IN-C
3	GND	13	GND
4	IN-A	14	N.C.
5	V _{CONT2}	15	V _{CONT3}
6	IN-B	16	OUT2
7	GND	17	GND
8	V _{DD}	18	N.C.
9	GND	19	GND
10	IN-D	20	OUT1

Remark N.C. : Non Connection

TRUTH TABLE

State	ON CHANNEL		CONTROL PINS			
	OUT1	OUT2	V _{CONT1}	V _{CONT2}	V _{CONT3}	V _{CONT4}
1	IN-A	IN-A	Low	Low	Low	Low
2		IN-B	Low	Low	Low	High
3		IN-C	Low	Low	High	Low
4		IN-D	Low	Low	High	High
5	IN-B	IN-A	Low	High	Low	Low
6		IN-B	Low	High	Low	High
7		IN-C	Low	High	High	Low
8		IN-D	Low	High	High	High
9	IN-C	IN-A	High	Low	Low	Low
10		IN-B	High	Low	Low	High
11		IN-C	High	Low	High	Low
12		IN-D	High	Low	High	High
13	IN-D	IN-A	High	High	Low	Low
14		IN-B	High	High	Low	High
15		IN-C	High	High	High	Low
16		IN-D	High	High	High	High

Remark High : +5 Vdc, Low : 0 Vdc.

FUNCTIONAL DIAGRAM

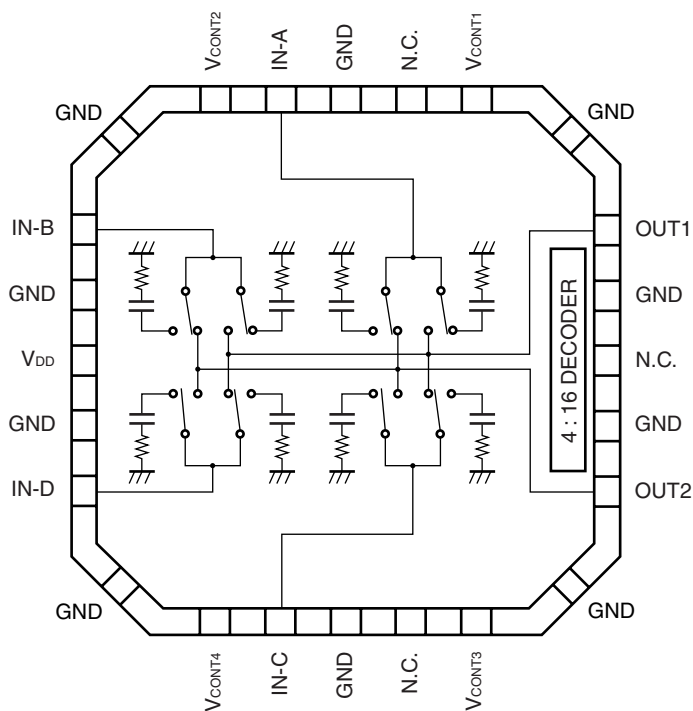

EVALUATION CIRCUIT ($V_{DD} = +5.0\text{ V}$, $V_{CONT} = +5.0\text{ V/0 V}$, $Z_o = 50\ \Omega$)

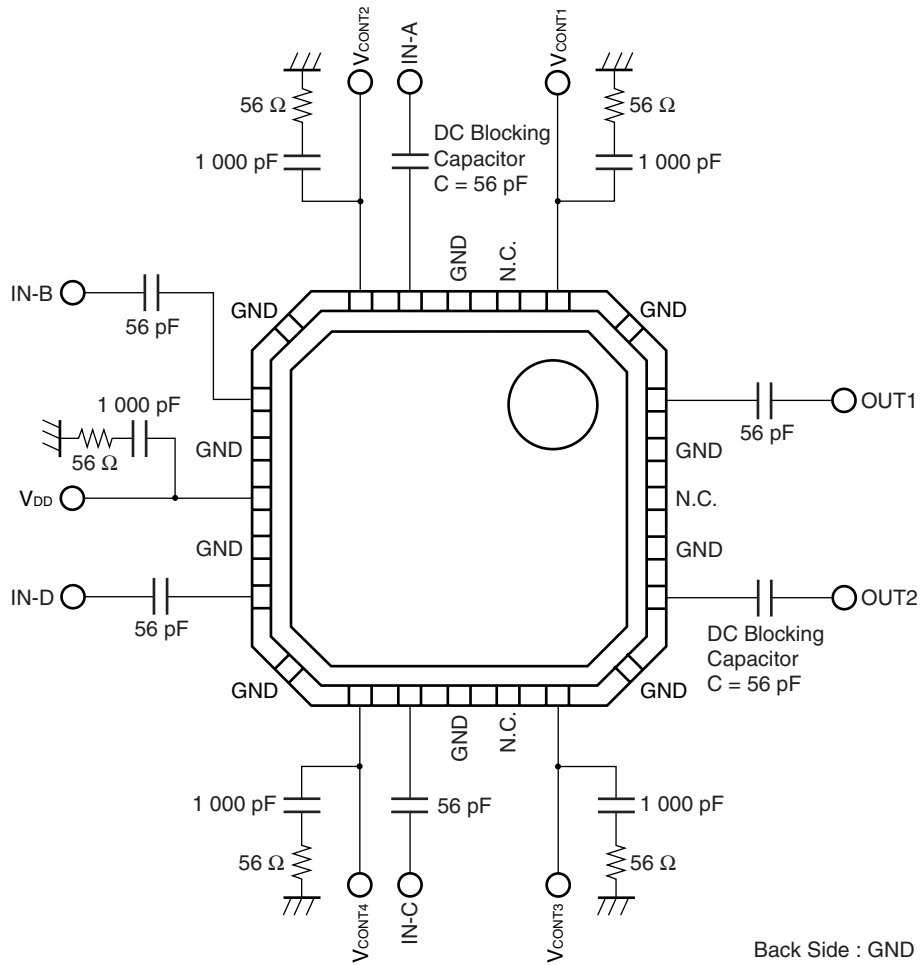

The application circuits and their parameters are for reference only and are not intended for use in actual design-ins.

TYPICAL CHARACTERISTICS

($T_A = +25^\circ\text{C}$, $V_{DD} = +5.0\text{ V}$, $V_{CONT} = +5.0\text{ V/0 V}$, $P_{in} = 0\text{ dBm}$, $Z_o = 50\ \Omega$, unless otherwise specified)

INSERTION LOSS vs. FREQUENCY

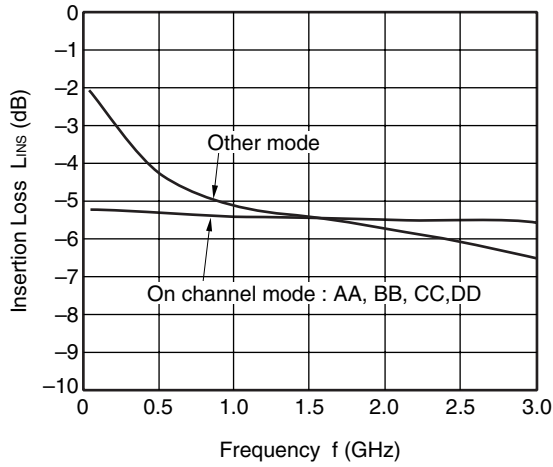

SIGNAL LEAKAGE vs. FREQUENCY

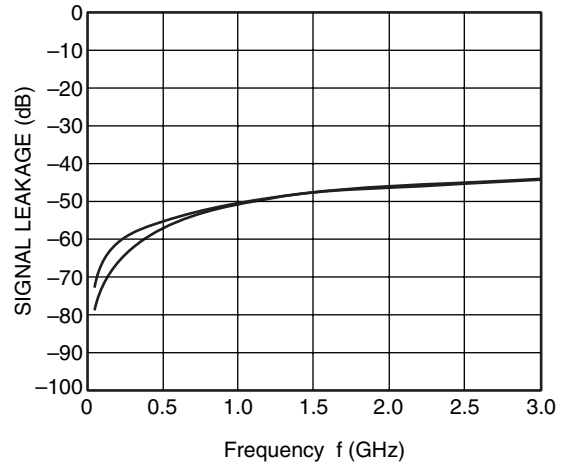

INPUT RETURN LOSS vs. FREQUENCY

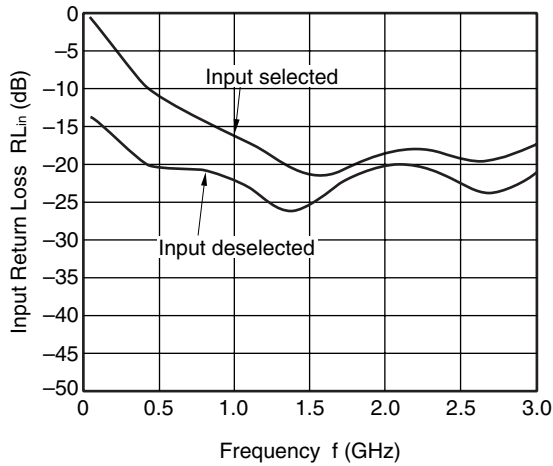

OUTPUT RETURN LOSS vs. FREQUENCY

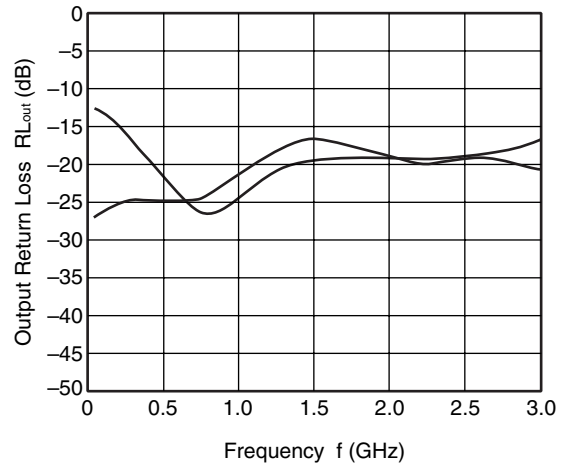

Remark The graphs indicate nominal characteristics.

INSERTION LOSS
vs. ON CHANNEL MODE

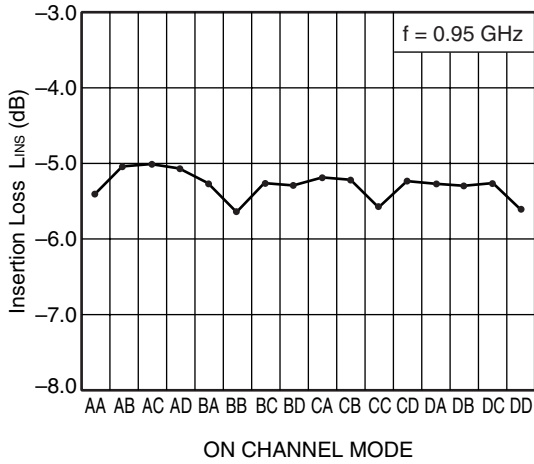

INSERTION LOSS
vs. ON CHANNEL MODE

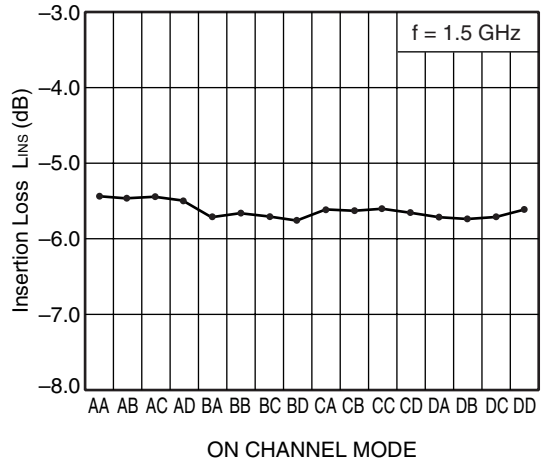

INSERTION LOSS
vs. ON CHANNEL MODE

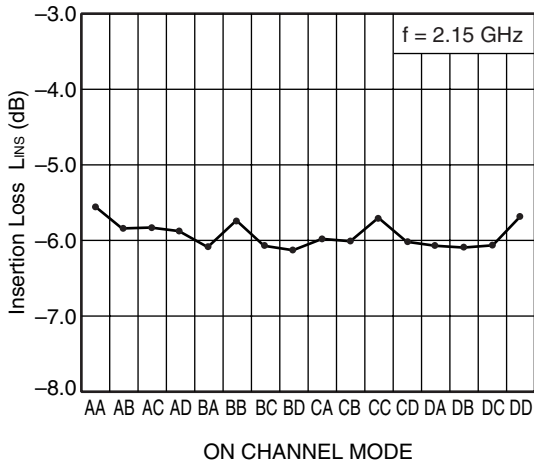

ISOLATION D/U-RATIO
vs. ON CHANNEL MODE

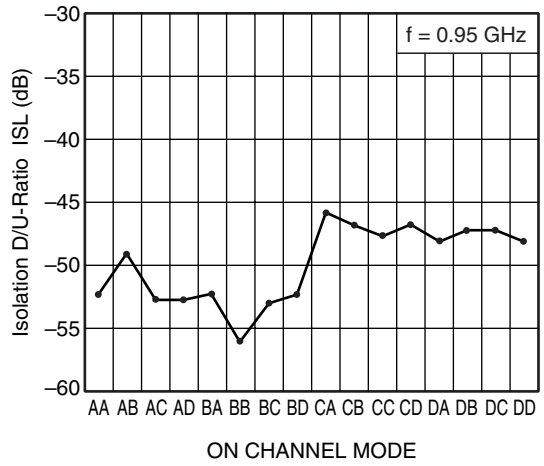

ISOLATION D/U-RATIO
vs. ON CHANNEL MODE

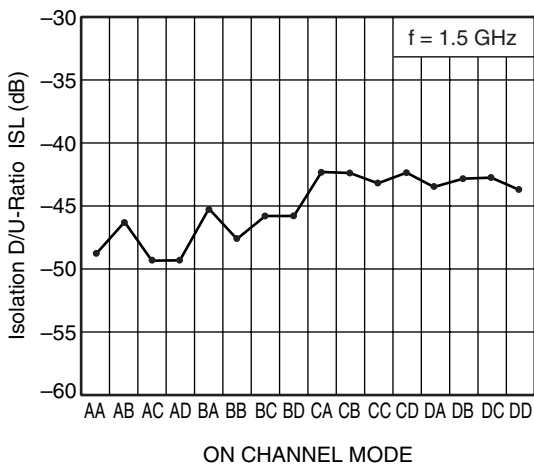

ISOLATION D/U-RATIO
vs. ON CHANNEL MODE

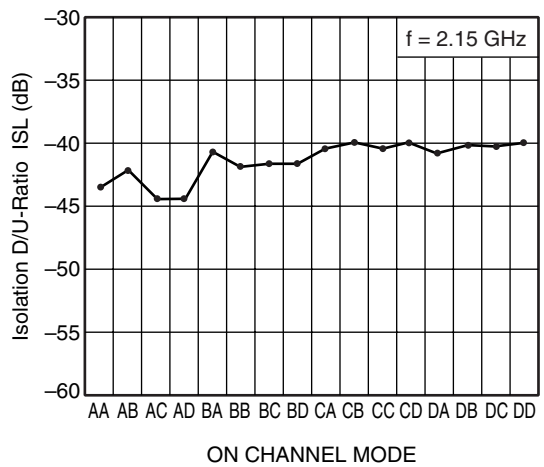

Remark The graphs indicate nominal characteristics.

ISOLATION D/U-RATIO vs. OPERATING AMBIENT TEMPERATURE

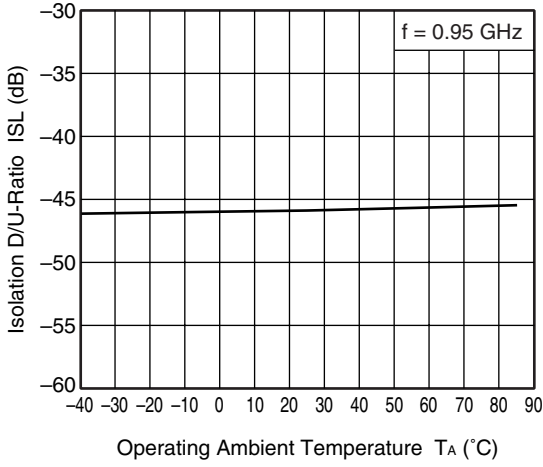

ISOLATION D/U-RATIO vs. OPERATING AMBIENT TEMPERATURE

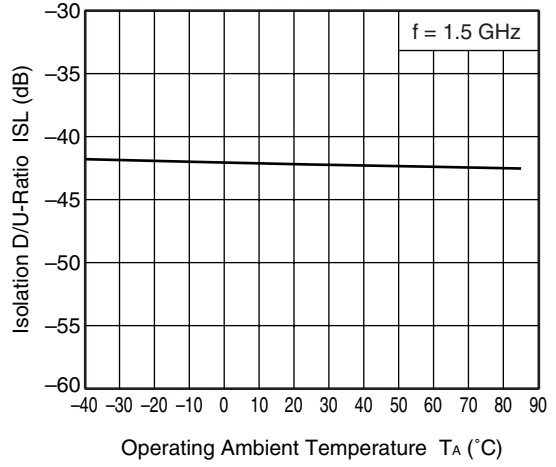

ISOLATION D/U-RATIO vs. OPERATING AMBIENT TEMPERATURE

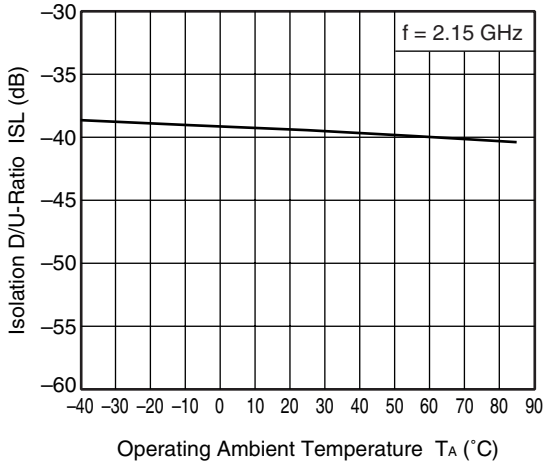

OUTPUT POWER, IM_3 vs. INPUT POWER

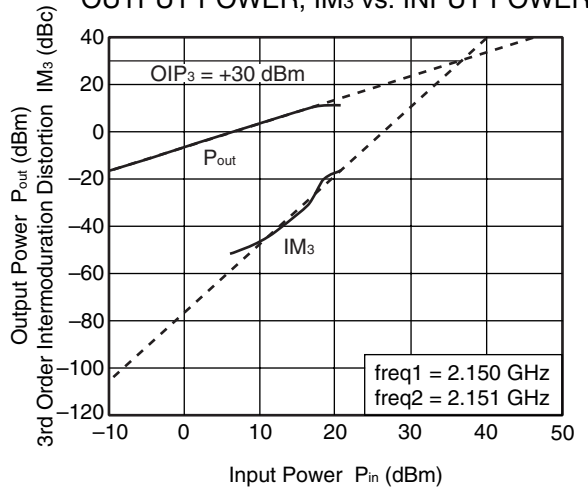

Remark The graphs indicate nominal characteristics.

PACKAGE DIMENSIONS

20-PIN 4 × 4 mm SQUARE MICRO LEAD PACKAGE (20-PIN QFN (0.5 mm pitch)) (UNIT: mm)

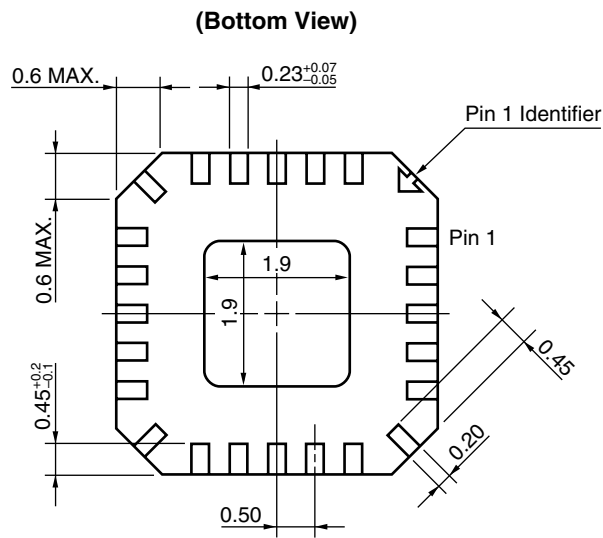
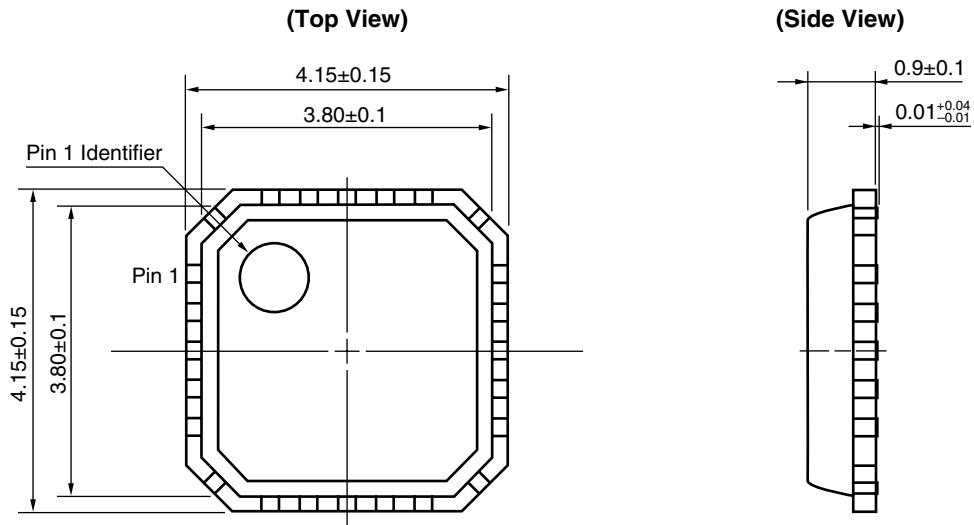

RECOMMENDED SOLDERING CONDITIONS

This product should be soldered and mounted under the following recommended conditions. For soldering methods and conditions other than those recommended below, contact your nearby sales office.

Soldering Method	Soldering Conditions	Condition Symbol
Infrared Reflow	Peak temperature (package surface temperature) : 260°C or below Time at peak temperature : 10 seconds or less Time at temperature of 220°C or higher : 60 seconds or less Preheating time at 120 to 180°C : 120±30 seconds Maximum number of reflow processes : 3 times Maximum chlorine content of rosin flux (% mass) : 0.2%(Wt.) or below	IR260
Partial Heating	Peak temperature (pin temperature) : 350°C or below Soldering time (per side of device) : 3 seconds or less Maximum chlorine content of rosin flux (% mass) : 0.2%(Wt.) or below	HS350

Caution Do not use different soldering methods together (except for partial heating).

- **The information in this document is current as of June, 2004. The information is subject to change without notice. For actual design-in, refer to the latest publications of NEC's data sheets or data books, etc., for the most up-to-date specifications of NEC semiconductor products. Not all products and/or types are available in every country. Please check with an NEC sales representative for availability and additional information.**
 - No part of this document may be copied or reproduced in any form or by any means without prior written consent of NEC. NEC assumes no responsibility for any errors that may appear in this document.
 - NEC does not assume any liability for infringement of patents, copyrights or other intellectual property rights of third parties by or arising from the use of NEC semiconductor products listed in this document or any other liability arising from the use of such products. No license, express, implied or otherwise, is granted under any patents, copyrights or other intellectual property rights of NEC or others.
 - Descriptions of circuits, software and other related information in this document are provided for illustrative purposes in semiconductor product operation and application examples. The incorporation of these circuits, software and information in the design of customer's equipment shall be done under the full responsibility of customer. NEC assumes no responsibility for any losses incurred by customers or third parties arising from the use of these circuits, software and information.
 - While NEC endeavours to enhance the quality, reliability and safety of NEC semiconductor products, customers agree and acknowledge that the possibility of defects thereof cannot be eliminated entirely. To minimize risks of damage to property or injury (including death) to persons arising from defects in NEC semiconductor products, customers must incorporate sufficient safety measures in their design, such as redundancy, fire-containment, and anti-failure features.
 - NEC semiconductor products are classified into the following three quality grades:
"Standard", "Special" and "Specific". The "Specific" quality grade applies only to semiconductor products developed based on a customer-designated "quality assurance program" for a specific application. The recommended applications of a semiconductor product depend on its quality grade, as indicated below. Customers must check the quality grade of each semiconductor product before using it in a particular application.
"Standard": Computers, office equipment, communications equipment, test and measurement equipment, audio and visual equipment, home electronic appliances, machine tools, personal electronic equipment and industrial robots
"Special": Transportation equipment (automobiles, trains, ships, etc.), traffic control systems, anti-disaster systems, anti-crime systems, safety equipment and medical equipment (not specifically designed for life support)
"Specific": Aircraft, aerospace equipment, submersible repeaters, nuclear reactor control systems, life support systems and medical equipment for life support, etc.
- The quality grade of NEC semiconductor products is "Standard" unless otherwise expressly specified in NEC's data sheets or data books, etc. If customers wish to use NEC semiconductor products in applications not intended by NEC, they must contact an NEC sales representative in advance to determine NEC's willingness to support a given application.
- (Note)
- (1) "NEC" as used in this statement means NEC Corporation, NEC Compound Semiconductor Devices, Ltd. and also includes its majority-owned subsidiaries.
 - (2) "NEC semiconductor products" means any semiconductor product developed or manufactured by or for NEC (as defined above).

M8E 00.4-0110

<p>Caution</p>	<p>GaAs Products</p>	<p>This product uses gallium arsenide (GaAs). GaAs vapor and powder are hazardous to human health if inhaled or ingested, so please observe the following points.</p> <ul style="list-style-type: none"> • Follow related laws and ordinances when disposing of the product. If there are no applicable laws and/or ordinances, dispose of the product as recommended below. <ol style="list-style-type: none"> 1. Commission a disposal company able to (with a license to) collect, transport and dispose of materials that contain arsenic and other such industrial waste materials. 2. Exclude the product from general industrial waste and household garbage, and ensure that the product is controlled (as industrial waste subject to special control) up until final disposal. • Do not burn, destroy, cut, crush, or chemically dissolve the product. • Do not lick the product or in any way allow it to enter the mouth.
-----------------------	----------------------	---

► For further information, please contact

NEC Compound Semiconductor Devices, Ltd. <http://www.ncsd.necel.com/>

E-mail: salesinfo@ml.ncsd.necel.com (sales and general)

techinfo@ml.ncsd.necel.com (technical)

Sales Division TEL: +81-44-435-1588 FAX: +81-44-435-1579

NEC Compound Semiconductor Devices Hong Kong Limited

E-mail: ncsd-hk@elhk.nec.com.hk (sales, technical and general)

Hong Kong Head Office TEL: +852-3107-7303 FAX: +852-3107-7309

Taipei Branch Office TEL: +886-2-8712-0478 FAX: +886-2-2545-3859

Korea Branch Office TEL: +82-2-558-2120 FAX: +82-2-558-5209

NEC Electronics (Europe) GmbH <http://www.ee.nec.de/>

TEL: +49-211-6503-0 FAX: +49-211-6503-1327

California Eastern Laboratories, Inc. <http://www.cel.com/>

TEL: +1-408-988-3500 FAX: +1-408-988-0279