

Features:

- ✓ 48 Vin, Isolated, 4:1 Fixed Conversion Ratio
- ✓ 220 Watt Nominal Output (at 48 Vin, 55 C, 200 LFM)
- ✓ 170 Watt Output (at 38 Vin, 55 C, 200 LFM)
- ✓ Industry Standard 1/8 Brick Footprint
- ✓ Remote Enable (Primary Side, Positive or Negative)
- ✓ Over-temperature and Over Current Protection
- ✓ Direct Parallel Operation for Higher Power Applications
- ✓ RoHS Compliant

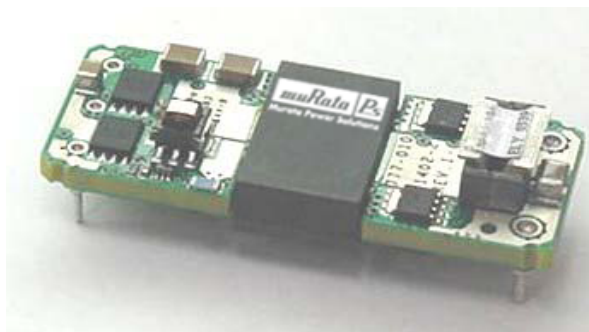

Table 1

Input Characteristics	Notes & Conditions (1)	Min	Typ.	Max	Units
Input Voltage Operating Range		36	48	55	Vdc
Input Voltage Absolute Maximum				60	Vdc
Input Undervoltage Lockout	Turn-on Threshold	36		37.5	Vdc
	Turn-off Threshold	34		35.5	Vdc
	Hysteresis Voltage		2		Vdc
Input Overvoltage Lockout	Turn-on Threshold	56		58	Vdc
	Turn-off Threshold	55		57	Vdc
	Hysteresis Voltage		2		Vdc
Maximum Input Current	Steady-State (23 A out)		5.5		Adc
No-Load Input Current	Enabled state, on load (48 Vin)		80		mA
Disabled Input Current	Disabled state (48 Vin)		6		mA
Input Reflected Ripple Current				50	mA p-p
Inrush Current Transient			0.2		A ² s
Enable – Negative Logic Version Internal 10 K pull-up to 5 V.	On State range	-0.1		0.8	Vdc
	Off State range	2.4		5.0	Vdc
Enable – Positive Logic Version Internal 100 K pull-down to GND.	On State range	2.4		5.0	Vdc
	Off State range	-0.1		0.8	Vdc

Table 2

Output Characteristics	Notes & Conditions (1)	Min	Typ.	Max	Units
Output Voltage Set Point (Vo=Vin/4 +0/-0.5%)	Vin = 48.0 V, Io = 0 A	11.94	11.98	12.0	Vdc
Output Load Regulation	Io = 0 to 15 A		0.7		V
Output Voltage Total Regulation	Vin = 36 to 55 V, Io = 0 to 15 A,	8.3		13.75	Vdc
	Vin = 42 to 53 V, Io = 0 to 15 A,	9.7		13.25	Vdc
Output Ripple Voltage & Noise	20 MHz Bandwidth		90	150	mV p-p
Output Current Operating Range		0		15	A
Efficiency	Vin = 48 V, Io = 15 A		96		%
Turn-On Time	Vin present: Enable to 90% Vout		10		mS
Start-up Inhibit Time	Enabled: Vin applied to 90% Vout		80		mS
Transient Response (3)	25% step, 0.1A/μs, ΔVo		160		mV
	Recovery Time			100	μs
Maximum Output Capacitance (4)				3000	μF



For full details go to
www.murata-ps.com/rohs

Table 1

Protection Characteristics	Notes & Conditions (1)	Min	Typ.	Max	Units
Output Over-Current Shutdown	Non-Latching	21	23	25	A
	Re-start rate		TBD		msec
Short Circuit Current	Peak		TBD		Ap
Over Temperature Shutdown (5)	Non-Latching		125	130	°C
Over Temperature Restart Hysteresis			10		°C

Table 2

General Specifications	Notes & Conditions (1)	Min	Typ.	Max	Units
Isolation Voltage	Input to Output	2250			Vdc
Isolation Resistance	Input to Output	10			Mohm
Storage Temperature Range	Non-condensing	-40		125	°C
Operating Temperature Range	Ambient (7)	-40		100	°C
Thermal Measurement Location Temperature (7)	See mechanical drawing for location			120	°C
Material Flammability	UL 94V-0				
MTBF	Calculated (Bellcore TR-332)	1	TBD		x10 ⁶ Hrs
	Demonstrated		TBD		x10 ⁶ Hrs
Dimension	2.28"L x 0.9"W x 0.48"H (max) (57.9L x 22.9W x 12.19H mm max)				
Weight					grams

Table 3

Standards Compliance	Notes & Conditions (6)
UL/CSA 60950	Basic Insulation
EN60950	Certified by TUV

Notes:

- (1) $V_{in} = 48V_{dc}$, $T_a = 25\text{ °C}$, Airflow = 200 LFM for all data unless otherwise noted.
- (2) Output ripple voltage and noise is specified when measured with no external capacitance.
- (3) Transient response is specified without a capacitor at the output of the converter.
- (4) Product operates with an external capacitance greater than specified. For higher values please contact a Celestica representative.
- (5) Thermal shutdown is monitored at the Thermal Measurement Location (TML). See 'Mechanical Information' on page 3 for TML location.
- (6) See 'Safety Considerations' shown on last page.
- (7) De-rating curves are conducted in a controlled environment. End application testing is required to ensure the Thermal Measurement Location temperature is below the maximum specified.
- (8) Recommended airflow direction is from pin 1 to pin 3, or 3 to 1 (transverse airflow).

Mechanical Information

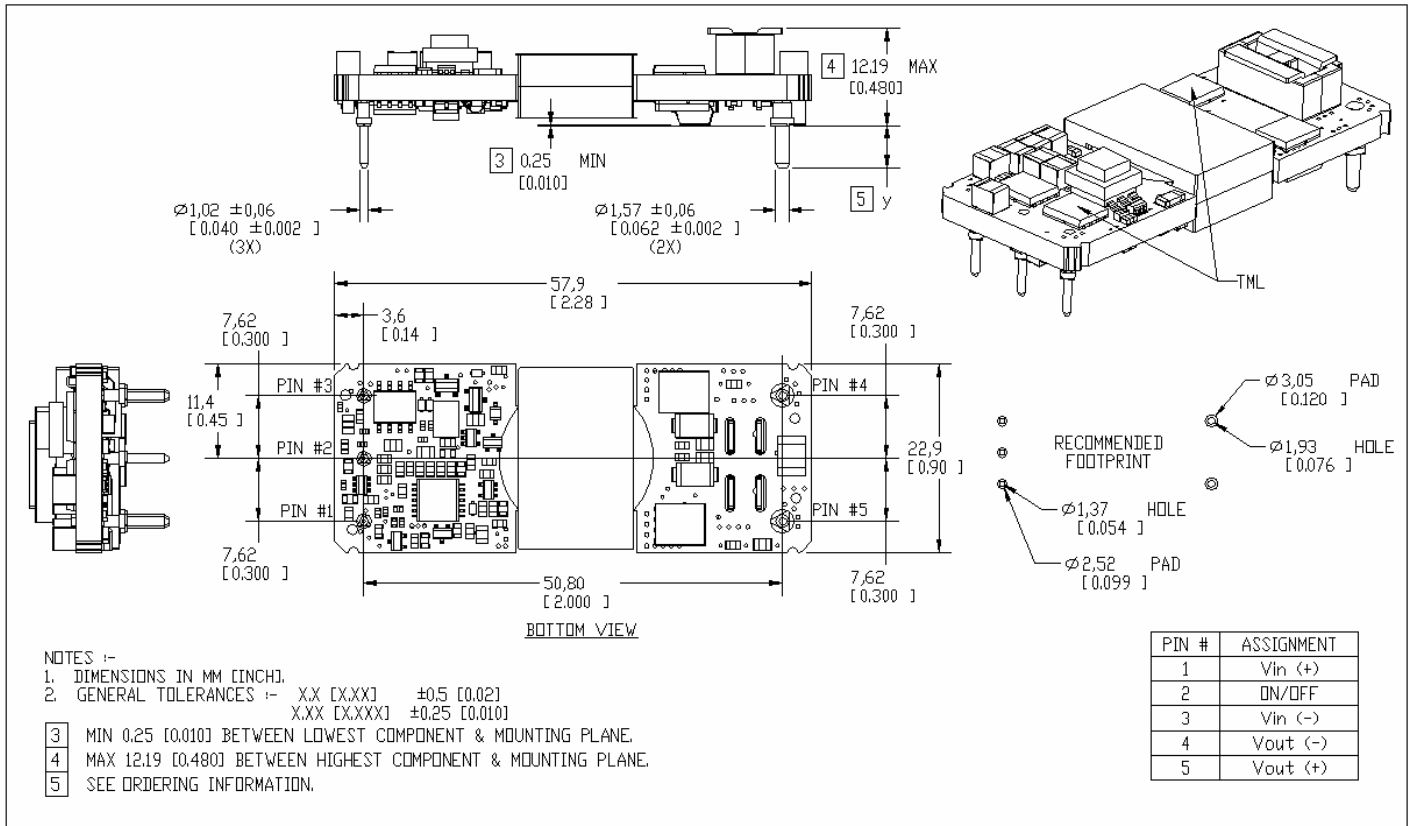

Figure 1

Pin Assignment

Table 4

Pin #	Pin Name	Function	Notes & Conditions
1	Vi(+)	Positive Input Voltage	
2	En	Input Enable / Disable	Referenced to Vi(-). Positive Logic: Floating = Enabled Negative Logic: Floating = Disabled
3	Vi(-)	Negative Input Voltage	
4	Vo(-)	Negative Output Voltage	
5	Vo(+)	Positive Output Voltage	

Efficiency Curves

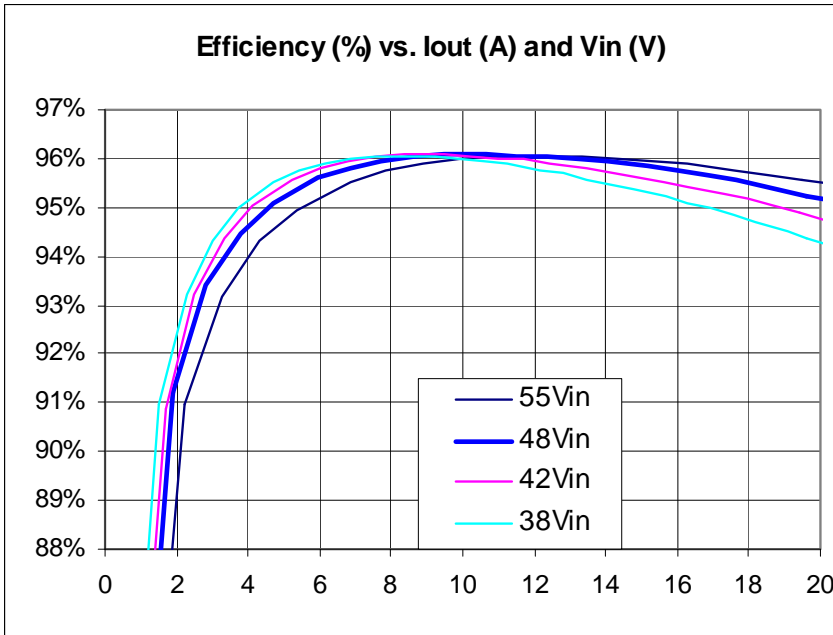

Figure 2

Output Voltage vs. Current

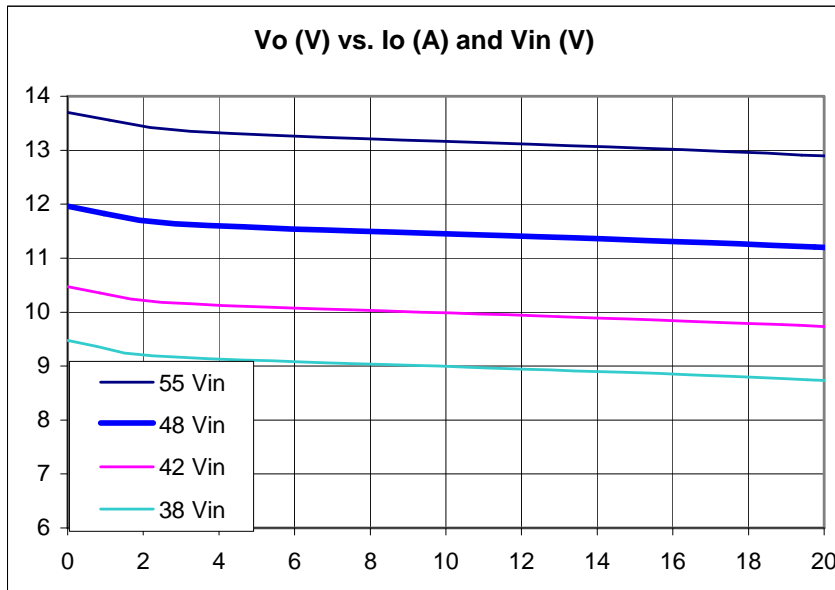

Figure 3

Airflow from pin 3 to pin 1

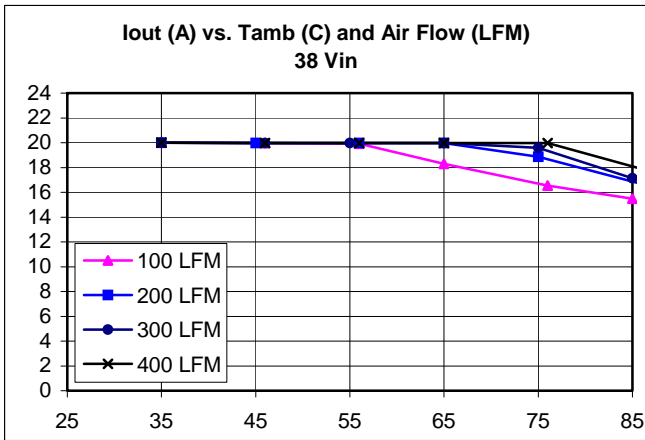

Figure 4

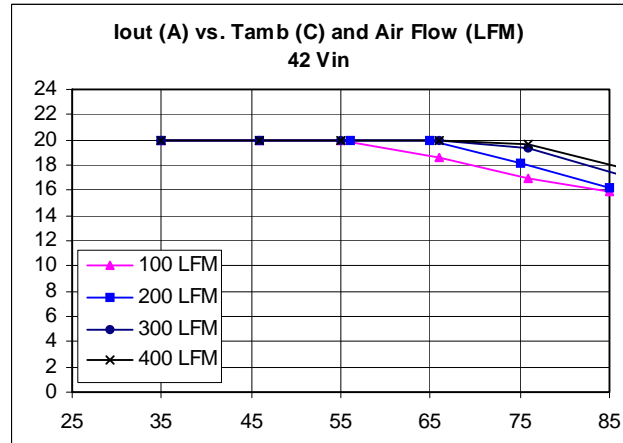

Figure 5

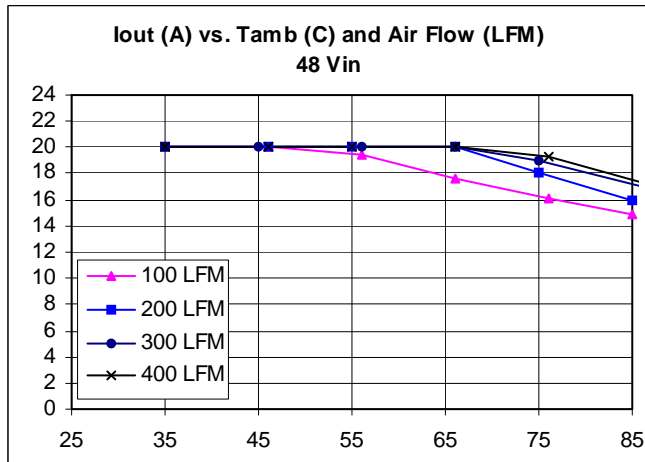

Figure 6

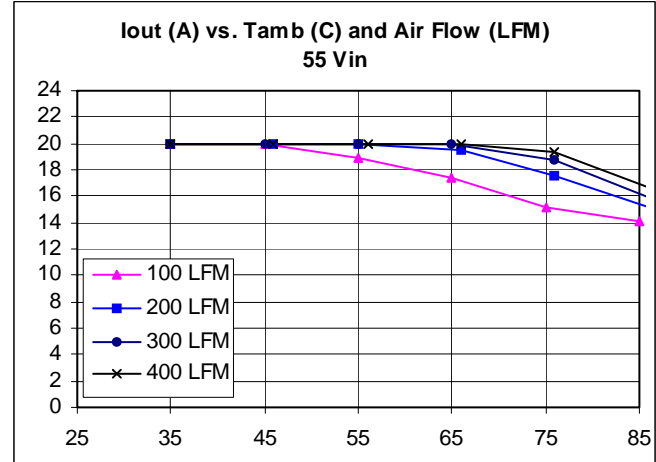

Figure 7

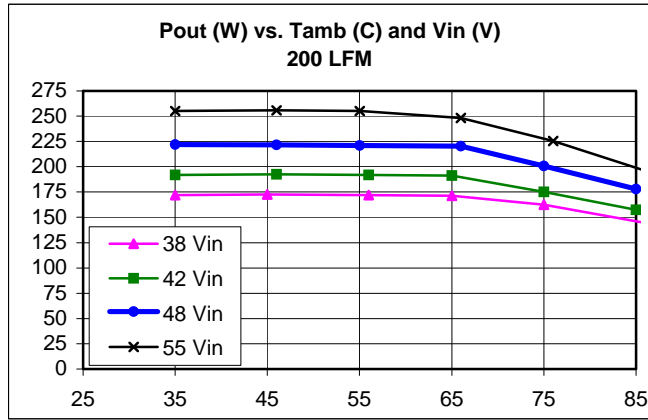

Figure 8

Turn-on from Vin (Enable On)

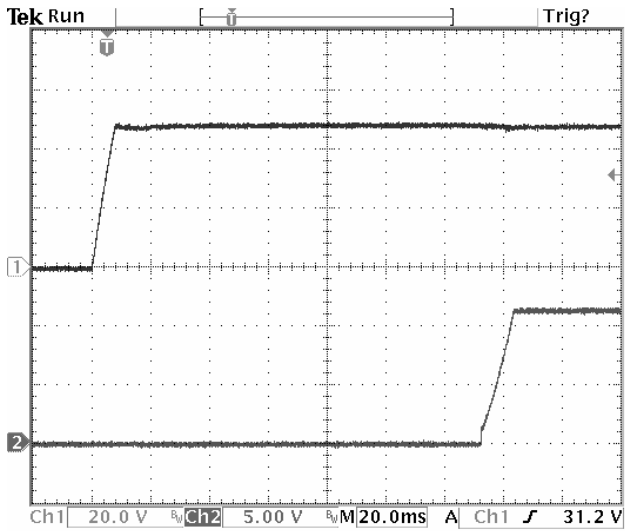

Figure 9 Ch3: En; Ch2: Vout
 $V_{in}=48V, I_o=15A, C_o=3000\mu F$

Turn-on from Enable (Vin present)

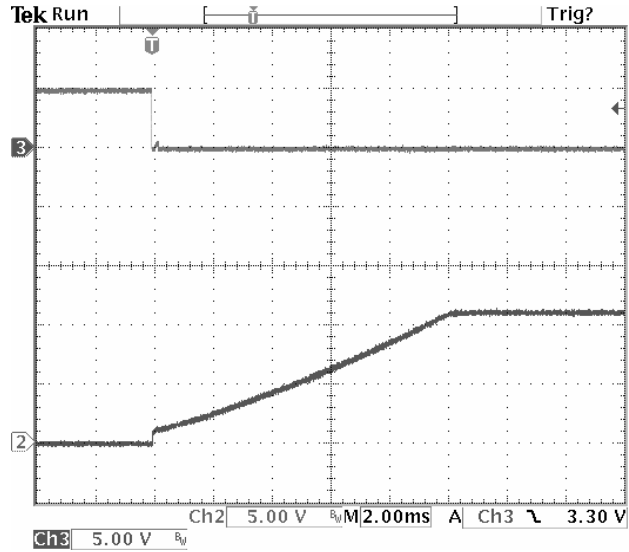

Figure 10 Ch3: Vin; Ch2: Vout
 $V_{in}=48V, I_o=15A, C_o=3000\mu F$

Output Ripple/Noise

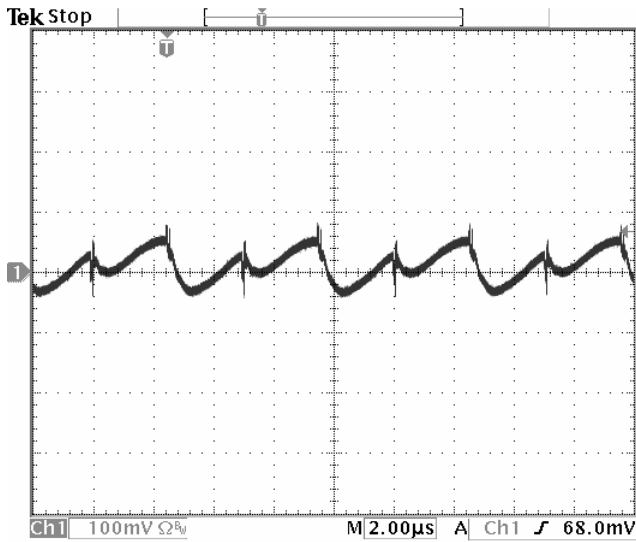

Figure 11 $V_{in}=48V, I_o=15A$
 Ripple = 114 mVpp

Safety Considerations

The EUS series of converters are certified to the standards listed in the 'Standards Compliance' section in the table above. If this product is built into information technology equipment, the installation must comply with the above standard.
 An external input fuse (10 A recommended), must be used to meet the above requirements.
 The output of the converter [Vo(+)/Vo(-)] is considered to remain within SELV limits when the input to the converter meets SELV or TNV-2 requirements.
 The converters and materials meet UL 94V-0 flammability ratings.

Figure 12

Ordering Information

