

### Features:

- ✓ 48 Vin, Isolated, 5:1 Fixed Conversion Ratio
- ✓ 240 Watt Output at 48 Vin, 55 C, 200 LFM
- ✓ 175 Watt Output at 38 Vin, 55 C, 200 LFM
- ✓ Industry Standard 1/8 Brick Footprint
- ✓ Remote Enable (Primary Side, Positive or Negative)
- ✓ Over-temperature and Over Current Protection
- ✓ Direct Parallel Operation for Higher Power
- ✓ RoHS Compliant

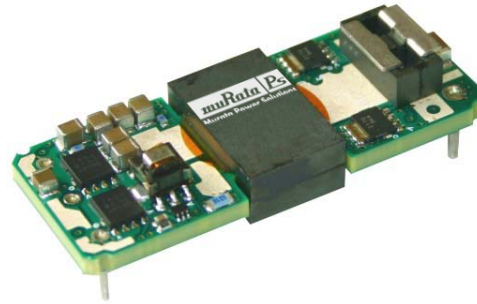

**Table 1**

Input Characteristics	Notes & Conditions	Min	Typ.	Max	Units
Input Voltage Operating Range		36	48	55	Vdc
Input Voltage Absolute Maximum				60	Vdc
Input Undervoltage Lockout	Turn-on Threshold	34		36	Vdc
	Turn-off Threshold	32		35	Vdc
	Hysteresis Voltage		2		Vdc
Input Overvoltage Lockout	Turn-on Threshold	55		58	Vdc
	Turn-off Threshold	56		59	Vdc
	Hysteresis Voltage		2		Vdc
Maximum Input Current	Steady-State (26 A out)		6.4		Adc
No-Load Input Current	Enabled state, no load (48 Vin)		50		mA
Disabled Input Current	Disabled state (48 Vin)		6		mA
Input Reflected Ripple Current	Note (9)			50	mA p-p
Inrush Current Transient			0.2		A <sup>2</sup> s
Enable – Negative Logic Version Internal 10 K pull-up to 5 V.	On State range	-0.1		0.8	Vdc
	Off State range	2.4		5.0	Vdc
Enable – Positive Logic Version Internal 100 K pull-down to GND.	On State range	2.4		5.0	Vdc
	Off State range	-0.1		0.8	Vdc

**Table 2**

Output Characteristics	Notes & Conditions	Min	Typ.	Max	Units
Output Voltage Set Point (Vo=Vin/5 +0/-0.5%)	Vin = 48.0 V, Io = 0 A	9.40	9.60	9.80	Vdc
Output Load Regulation	Io = 0 to 25 A		0.5		V
Output Voltage Total Regulation	Vin = 38 to 55 V, Io = 0 to 25 A,	6.60		11.20	Vdc
	Vin = 42 to 53 V, Io = 0 to 25 A,	7.80		10.7	Vdc
Output Ripple Voltage & Noise	20 MHz Bandwidth		90	150	mV p-p
Output Current Operating Range		0		25	A
Output Current Share Accuracy	Percent deviation from ideal (8)		< 10		%
Efficiency	Vin = 48 V, Io = 25 A		95		%
Turn-On Time	Vin present: Enable to 90% Vout		10		mS
Start-up Inhibit Time	Enabled: Vin applied to 90% Vout		120		mS
Transient Response	25% step, 0.1A/μs, ΔVo		160		mV
	Recovery Time			100	μs
Maximum Output Capacitance				3000	μF



Table 3

Protection Characteristics	Notes & Conditions	Min	Typ.	Max	Units
Output Over-Current Shutdown	Non-Latching	27	30	33	A
	Re-start rate		60		msec
Over Temperature Shutdown	Non-Latching		125	130	°C
Over Temperature Restart Hysteresis			10		°C

Table 4

General Specifications	Notes & Conditions	Min	Typ.	Max	Units
Isolation Voltage	Input to Output	2250			Vdc
Isolation Resistance	Input to Output	10			Mohm
Storage Temperature Range	Non-condensing	-40		125	°C
Operating Temperature Range	Ambient	-40		100	°C
Thermal Measurement Location Temperature	See mechanical drawing for TML location			120	°C
Material Flammability	UL 94V-0				
MTBF	Calculated (Bellcore TR-332)		2.7		x10 <sup>6</sup> Hrs
	Demonstrated		> 2		x10 <sup>6</sup> Hrs
Dimension	2.28"L x 0.9"W x 0.48"H (max) (57.9L x 22.9W x 12.19H mm max)				
Weight			30		grams

Table 5

Standards Compliance	Notes & Conditions (6)
UL/CSA 60950	Basic Insulation
EN60950	Certified by TUV

### Notes:

- (1)  $V_{in} = 48V_{dc}$ ,  $T_a = 25\text{ }^{\circ}\text{C}$ , Airflow = 200 LFM for all data unless otherwise noted.
- (2) Output Ripple Voltage and noise is specified when measured with a 10uF tantalum and a 1uF ceramic capacitor at the converter output pins.
- (3) Transient response is specified without a capacitor at the output of the converter.
- (4) Thermal shutdown is monitored at the Thermal Measurement Location (TML). See 'Mechanical Information' on page 3 for TML location.
- (5) See 'Safety Considerations' shown in Figure 1.
- (6) De-rating curves are conducted in a controlled environment. End application testing is required to ensure the Thermal Measurement Location temperature is below the maximum specified.
- (7) Recommended airflow direction is from pin 1 to pin 3, or 3 to 1 (transverse).
- (8) Current share accuracy is optimized when the source and load impedance presented to each converter is equal.
- (9) Input Reflected Ripple is specified when measured with a 12uH source inductance. Without an input filter inductor, input ripple is less than 1 Arms for an input filter capacitance rated 70 mohms esr

**Mechanical Information**

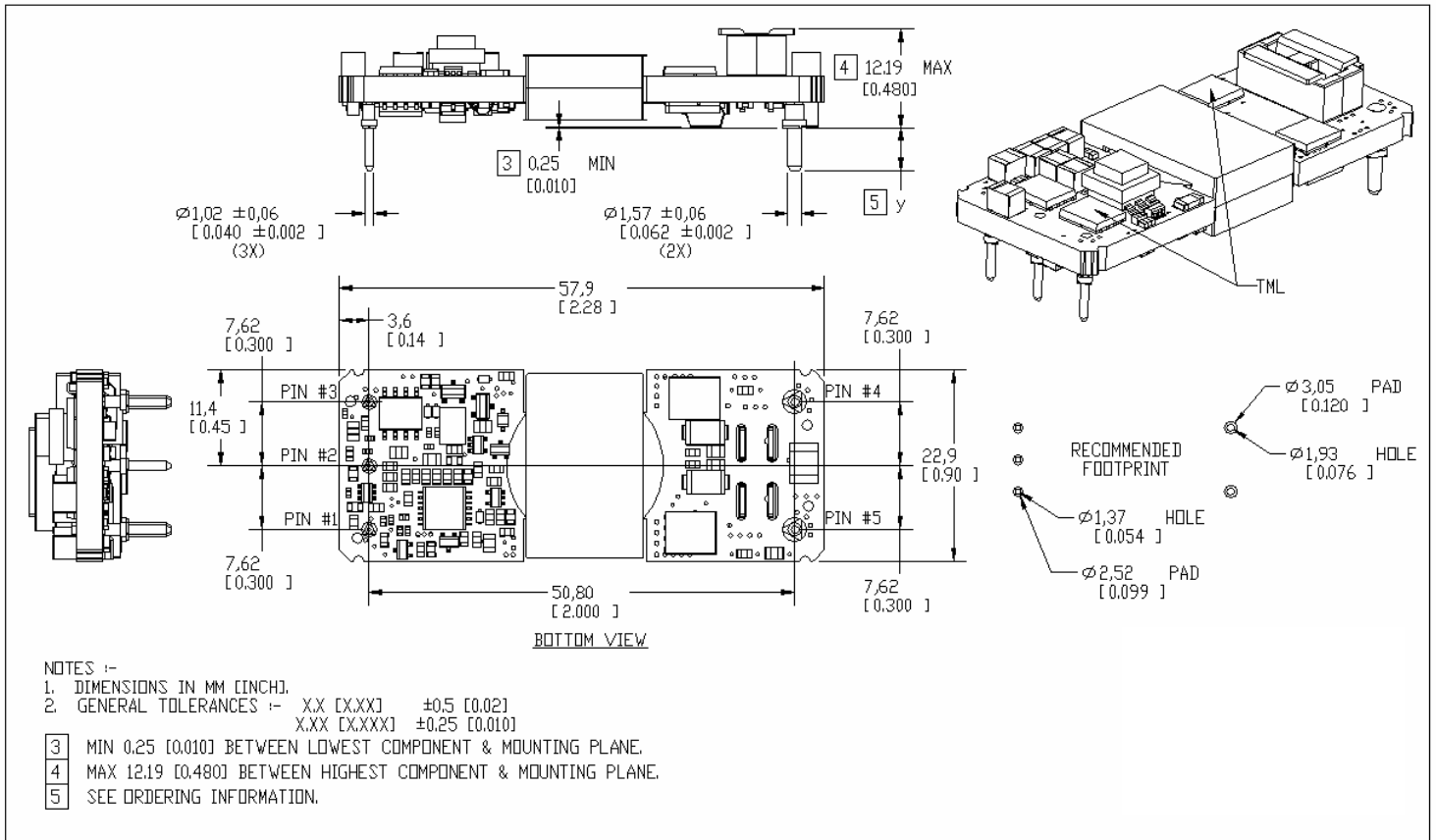

Figure 1

**Pin Assignment**

Table 6

Pin #	Pin Name	Function	Notes & Conditions
1	Vi(+)	Positive Input Voltage	
2	En	Input Enable / Disable	Referenced to Vi(-). Positive Logic: Floating = Enabled Negative Logic: Floating = Disabled
3	Vi(-)	Negative Input Voltage	
4	Vo(-)	Negative Output Voltage	
5	Vo(+)	Positive Output Voltage	

**Efficiency Curves**

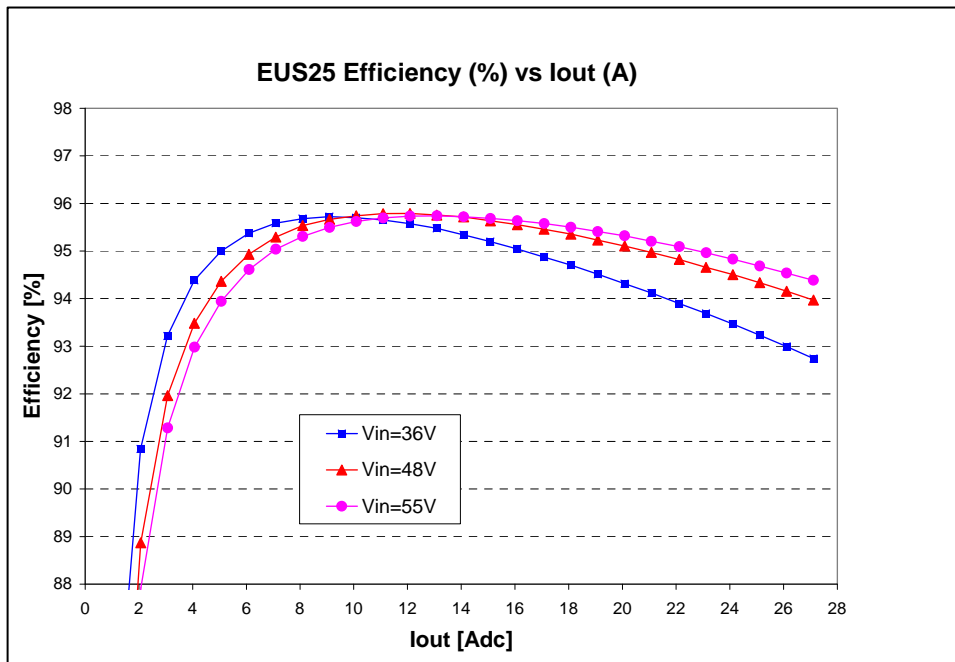

Figure 2

**Output Voltage vs. Current**

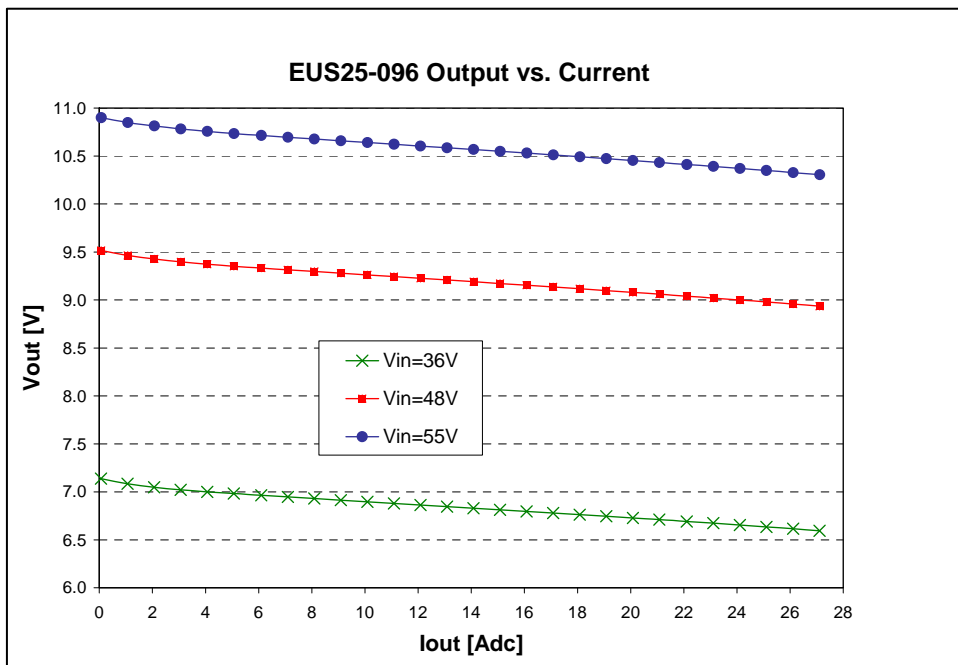

Figure 3

**Power Derating Curves,  $T_{TML}=120C$**

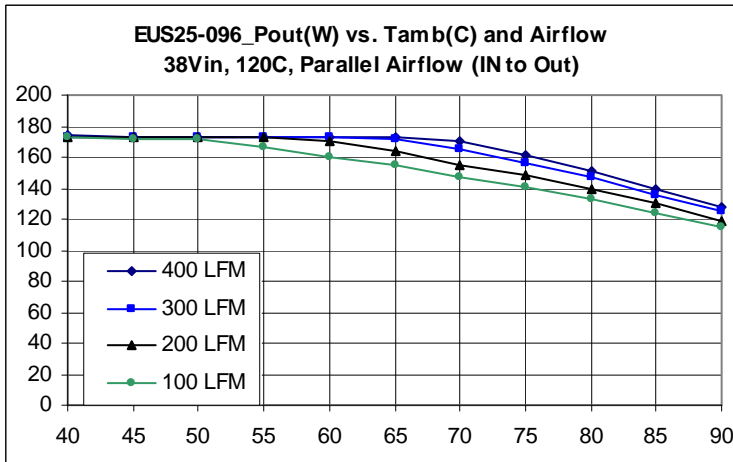

Figure 4

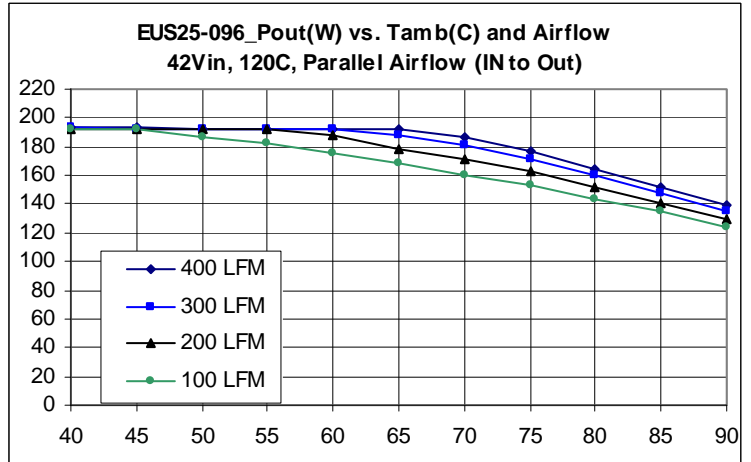

Figure 5

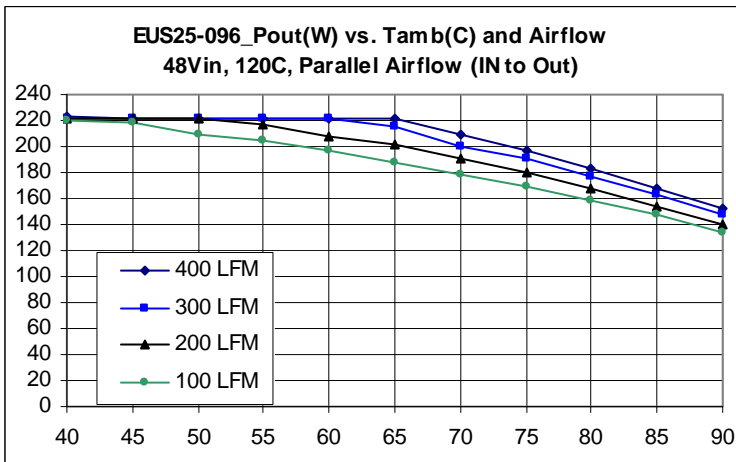

Figure 6

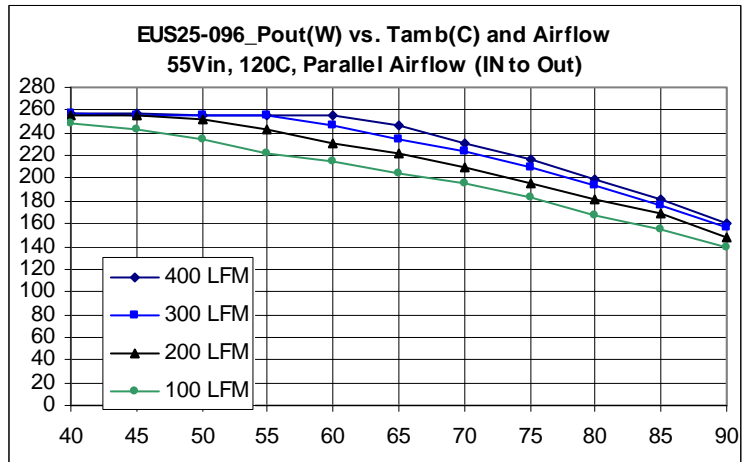

Figure 7

**Output Power as a function of Ambient Temperature and Input Voltage**

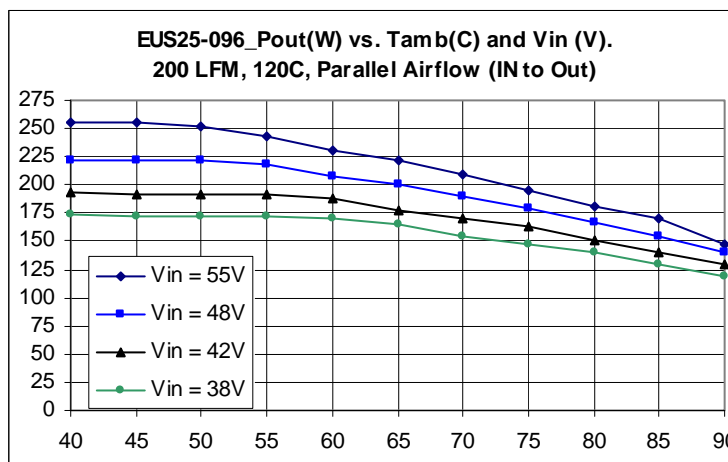

Figure 8

### Turn-on from Vin (Enable On)

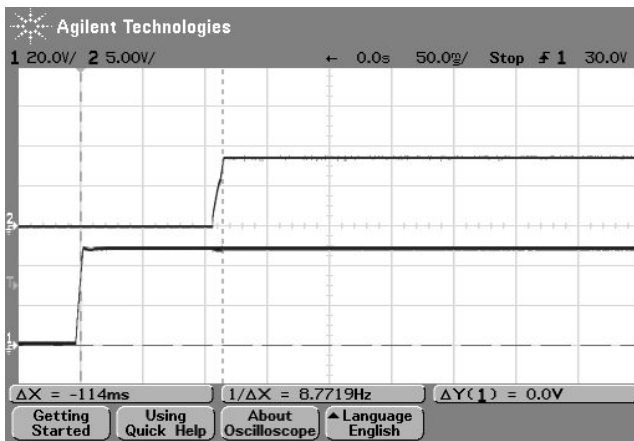

Figure 9 Ch1: Vin; Ch2: Vout  
Vin=48V, Io=22A, Co=3000uF

### Turn-on from Enable (Vin present)

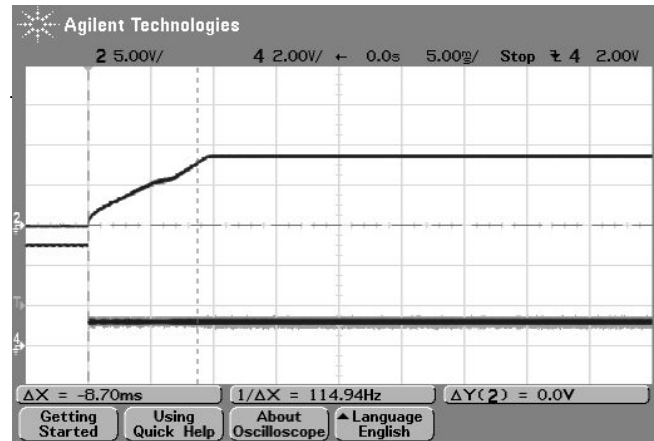

Figure 10 Ch2: Vout; Ch4: Enable  
Vin=48V, Io=22A, Co=3000uF

### Output Ripple/Noise

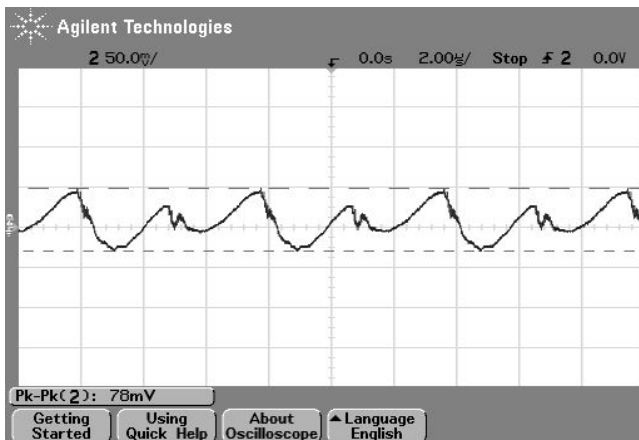

Figure 11 Vout @ 50 mV/div. Vin=48V, Io=25A, Co = 0

### Thermal Image

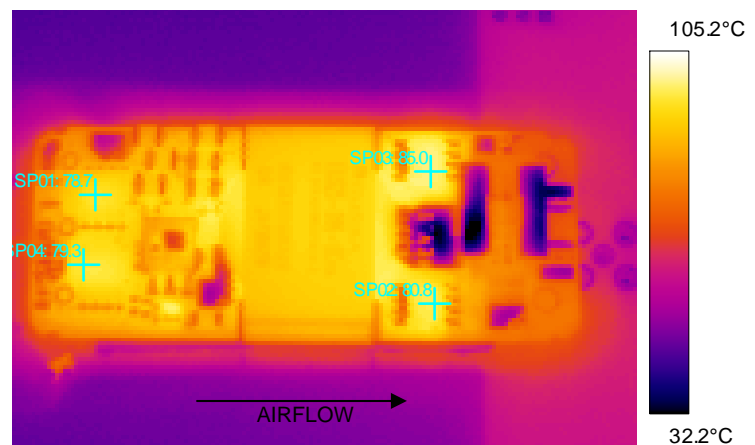
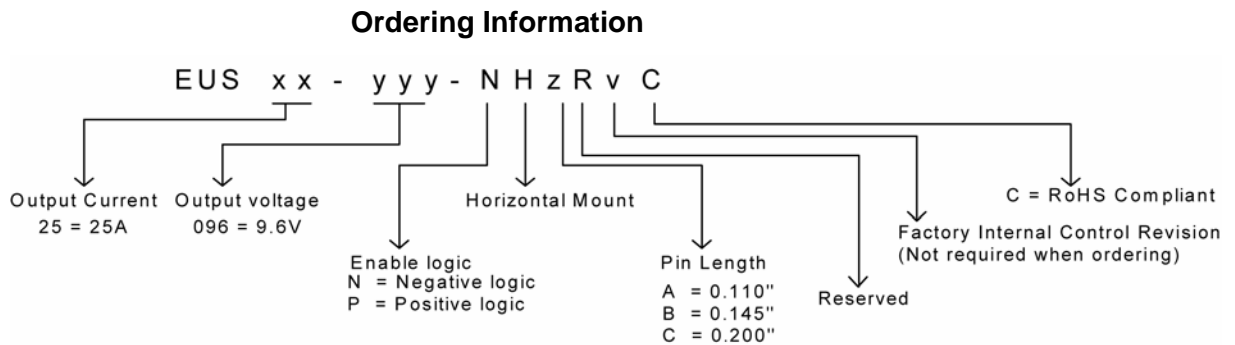

Figure 12 Vi=42 V, Iout=25 A, @ 25 C, 200 LFM

**Safety Considerations**

The EUS series of converters are certified to the standards listed in the 'Standards Compliance' section in the table above. If this product is built into information technology equipment, the installation must comply with the above standard. An external input fuse (10 A recommended), must be used to meet the above requirements. The output of the converter [Vo(+)/Vo(-)] is considered to remain within SELV limits when the input to the converter meets SELV or TNV-2 requirements. The converters and materials meet UL 94V-0 flammability ratings.

Figure 13



**RoHS Compliant**

The EUS series of converters is in compliance with the European Union Directive 2002/95/EC (RoHS) with respect to the following substances: lead (Pb), mercury (Hg), cadmium (Cd), hexavalent chromium, polybrominated biphenyls (PBB) or polybrominated diphenyl ethers (PBDE).