

SVC Varistors Type

Introduction

SVC series Varistors are gapless ceramic surge absorbers of a new type made of metal oxide which is designed to protect various kinds of electronic devices and semiconducting elements from surges.

Features

- High discharge current capability up to 4000 Amps.
- Excellent clamping characteristics.
- Fast response time under 50 nanoseconds.
- Improve Product safety
- UL, CSA, VDE recognized

How to Order

SVC 471 D-14A FF 7

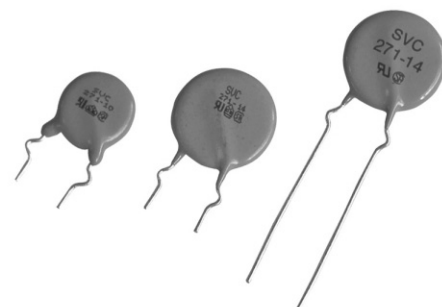

1 Basic Type

ZnO Varistor

2 Varistor Nominal Voltage

(The first two digit indicate significant digits)
(The 3rd digit indicate the number of zeros following)

3 Style

D : Disk Type Varistor

4 Chip Element Size(Dia)

05 : Ø5mm, 07 : Ø7mm,
10 : Ø10mm, 14 : Ø14mm,
20 : Ø20mm

5 Classification

A : High Voltage(82V and above)
B : Low Voltage(less than 68V)

6 Packing Style & Lead Variation

7 Lead Spacing & Pitch of Component

Packing Style		Lead Variation		Packing Style		Lead Variation	
F	Taping Type Flat Pack	S	Straight Type	B	Bulk	S	Straight Long Type
		K	In-Kink Type			K	Kink Short Type
		F	Out-Kink Type			L	Kink Long Type
		N	Straight Short Type				

Suffix Code

Taping Type			Bulk Type	
Code	Lead Spacing(mm)	Pitch of Component(mm)	Code	Lead Spacing(mm)
5	5.0	12.7	5	5.0
7	7.5	15.0	7	7.5
8	7.5	30.0	1	10.0
9	7.5	25.4		
1	10.0	30.0		

SVC Characteristic Curves

V - I Curve

- Small - current region of V - I curve

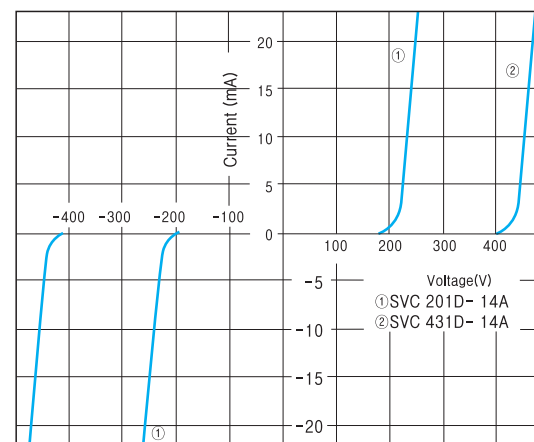

- Temporary power frequency over voltage capability

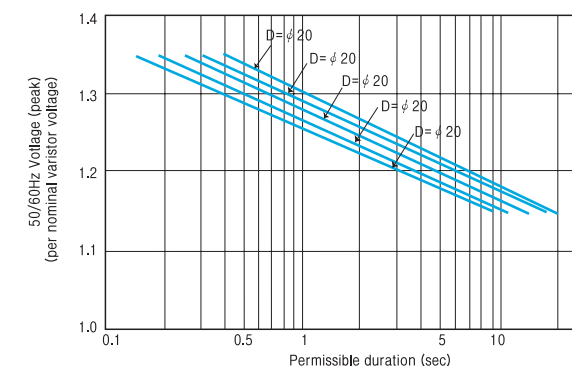

B Type

- Withstand discharge impulse current characteristics(Typical)

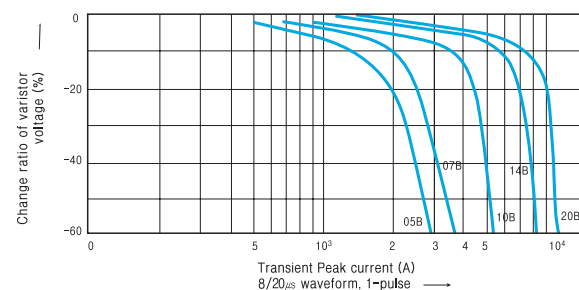

A Type

- Withstand discharge impulse current characteristics(Typical)

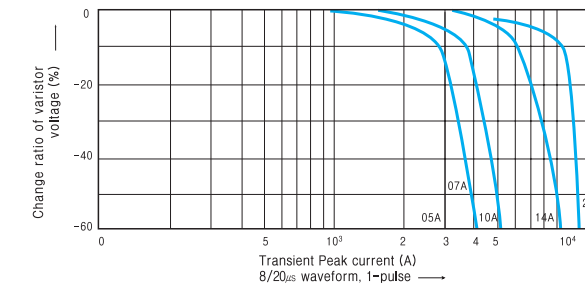

Specification

Device Type	Chip Element Size	Maximum Ratings					Characteristics					
		Applied Voltage		Transient			Nominal Varistor ^④ Peak Voltage		Max. Clamping ^⑤ Voltage @ Test Current(8/20 μ s)		Typical Capacitance	
		RMS 50/60Hz (25 $^{\circ}$ C)	DC (25 $^{\circ}$ C)	Energy ^②	Average Power Dissipation	Peak ^③ Current (8/20 μ s)						
		Dia (mm)	Vacm (Volts)	Vdcm (Volts)	Wtm (Joules)	Ptam (Watts)	I _{tm} (Amps)	V _{nom} (Volts)	Tolerance		V _c (Volts)	I _p (Amps)
							Min.(Volts)	Max.(Volts)				
SVC 180D-05B	5			0.3	0.01	125				40	1	1700
SVC 180D-07B	7			0.8	0.02	250				36	2.5	3500
SVC 180D-10B	10	11	14	1.5	0.05	500	18	16	20	36	5	7000
SVC 180D-14B	14			3.5	0.1	1000				36	10	1400
SVC 180D-20B	20			10.0	0.2	2000				36	20	28000
SVC 220D-05B	5			0.4	0.01	125				48	1	1200
SVC 220D-07B	7			0.9	0.02	250				43	2.5	2500
SVC 220D-10B	10	14	18	2.0	0.05	500	22	20	24	43	5	5000
SVC 220D-14B	14			4.0	0.1	1000				43	10	11000
SVC 220D-20B	20			13.0	0.2	2000				43	20	22000
SVC 270D-05B	5			0.5	0.01	125				60	1	1100
SVC 270D-07B	7			1.0	0.02	250				53	2.5	2000
SVC 270D-10B	10	17	22	2.5	0.05	500	27	24	30	53	5	4500
SVC 270D-14B	14			5.0	0.1	1000				54	10	9000
SVC 270D-20B	20			15.0	0.2	2000				53	20	18000
SVC 330D-05B	5			0.6	0.01	125				73	1	1000
SVC 330D-07B	7			1.2	0.02	250				65	2.5	2000
SVC 330D-10B	10	20	26	3.0	0.05	500	33	30	36	65	5	4000
SVC 330D-14B	14			6.0	0.1	1000				65	10	8000
SVC 330D-20B	20			20.0	0.2	2000				65	20	16000
SVC 390D-05B	5			0.8	0.01	125				86	1	800
SVC 390D-07B	7			1.5	0.02	250				77	2.5	1600
SVC 390D-10B	10	25	31	3.5	0.05	500	39	35	43	77	5	3200
SVC 390D-14B	14			7.0	0.1	1000				77	10	6500
SVC 390D-20B	20			24.0	0.2	2000				77	20	13000
SVC 470D-05B	5			1.0	0.01	125				104	1	700
SVC 470D-07B	7			1.8	0.02	250				93	2.5	1400
SVC 470D-10B	10	30	38	4.5	0.05	500	47	42	52	93	5	2800
SVC 470D-14B	14			8.5	0.1	1000				93	10	5500
SVC 470D-20B	20			30.0	0.2	2000				93	20	11000
SVC 560D-05B	5			1.0	0.01	125				123	1	600
SVC 560D-07B	7			2.2	0.02	250				110	2.5	1300
SVC 560D-10B	10	35	45	5.5	0.05	500	56	50	62	110	5	2500
SVC 560D-14B	14			10.5	0.1	1000				110	10	5000
SVC 560D-20B	20			35.0	0.2	2000				110	20	10000
SVC 680D-05B	5			1.2	0.01	125				150	1	500
SVC 680D-07B	7			2.5	0.02	250				135	2.5	1000
SVC 680D-10B	10	40	56	6.5	0.05	500	68	61	75	135	5	2000
SVC 680D-14B	14			12.0	0.1	1000				135	10	4000
SVC 680D-20B	20			40.0	0.2	2000				135	20	8000
SVC 820D-05A	5			1.7	0.1	400				145	5	400
SVC 820D-07A	7			3.5	0.25	1200				135	10	800
SVC 820D-10A	10	50	65	8.0	0.4	2500	82	74	90	135	25	1500
SVC 820D-14A	14			14.0	0.6	4500				135	50	3000
SVC 820D-20A	20			27.0	1.0	6500				135	100	6000
SVC 101D-05A	5			2.0	0.1	400				175	5	350
SVC 101D-07A	7			4.0	0.25	1200				165	10	700
SVC 101D-10A	10	60	85	10.0	0.4	2500	100	90	110	165	25	1500
SVC 101D-14A	14			18.0	0.6	4500				165	50	3000
SVC 101D-20A	20			30.0	1.0	6500				165	100	6000

Device Type	Chip Element Size	Maximum Ratings					Characteristics					
		Applied Voltage		Transient			Nominal Varistor ^④ Peak Voltage		Max. Clamping ^⑤ Voltage @ Test Current(8/20 μ s)		Typical Capacitance	
		RMS 50/60Hz (25 $^{\circ}$ C)	DC (25 $^{\circ}$ C)	Energy ^②	Average Power Dissipation	Peak ^③ Current (8/20 μ s)						
		Dia (mm)	Vacm (Volts)	Vdcm (Volts)	Wtm (Joules)	Ptam (Watts)	I _{tm} (Amps)	V _{nom} (Volts)	Tolerance		V _c (Volts)	I _p (Amps)
							Min.(Volts)	Max.(Volts)				
SVC 121D-05A	5			2.5	0.1	400				210	5	350
SVC 121D-07A	7			5.0	0.25	1200				200	10	700
SVC 121D-10A	10	75	100	12.0	0.4	2500	120	108	132	200	25	1300
SVC 121D-14A	14			20.0	0.6	4500				200	50	2600
SVC 121D-20A	20			40.0	1.0	6500				200	100	5200
SVC 151D-05A	5			3.0	0.1	400				260	5	250
SVC 151D-07A	7			6.0	0.25	1200				250	10	500
SVC 151D-10A	10	95	125	16.0	0.4	2500	150	135	165	250	25	1000
SVC 151D-14A	14			25.0	0.6	4500				250	50	2000
SVC 151D-20A	20			50.0	1.0	6500				250	100	4000
SVC 201D-05A	5			4.0	0.1	400				355	5	200
SVC 201D-07A	7			10.0	0.25	1200				340	10	400
SVC 201D-10A	10	130	170	20.0	0.4	2500	200	185	225	340	25	800
SVC 201D-14A	14			35.0	0.6	4500				340	50	1600
SVC 201D-20A	20			70.0	1.0	6500				340	100	3200
SVC 221D-05A	5			4.5	0.1	400				380	5	170
SVC 221D-07A	7			10.0	0.25	1200				360	10	350
SVC 221D-10A	10	140	180	23.0	0.4	2500	220	198	242	360	25	700
SVC 221D-14A	14			40.0	0.6	4500				360	50	1400
SVC 221D-20A	20			75.0	1.0	6500				360	100	2800
SVC 241D-05A	5			5.0	0.1	400				415	5	170
SVC 241D-07A	7			10.0	0.25	1200				395	10	350
SVC 241D-10A	10	150	200	25.0	0.4	2500	240	216	264	395	25	700
SVC 241D-14A	14			40.0	0.6	4500				395	50	1300
SVC 241D-20A	20			80.0	1.0	6500				395	100	2600
SVC 271D-05A	5			6.0	0.1	400				475	5	150
SVC 271D-07A	7			12.0	0.25	1200				455	10	300
SVC 271D-10A	10	175	225	30.0	0.4	2500	270	247	303	455	25	600
SVC 271D-14A	14			50.0	0.6	4500				455	50	1200
SVC 271D-20A	20			90.0	1.0	6500				455	100	2400
SVC 361D-05A	5			7.5	0.1	400				620	5	120
SVC 361D-07A	7			15.0	0.25	1200				595	10	250
SVC 361D-10A	10	230	300	35.0	0.4	2500	360	324	396	595	25	500
SVC 361D-14A	14			65.0	0.6	4500				595	50	1000
SVC 361D-20A	20			120.0	1.0	6500				595	100	2000
SVC 391D-05A	5			8.0	0.1	400				675	2.55	110
SVC 391D-07A	7			17.0	0.25	1200				650	10	220
SVC 391D-10A	10	250	320	40.0	0.4	2500	390	351	429	650	25	450
SVC 391D-14A	14			70.0	0.6	4500				650	50	900
SVC 391D-20A	20			130.0	1.0	6500				650	100	1800
SVC 431D-05A	5			9.0	0.1	400				754	5	100
SVC 431D-07A	7			20.0	0.25	1200				710	10	200
SVC 431D-10A	10	275	350	45.0	0.4	2500	430	387	473	710	25	400
SVC 431D-14A	14			75.0	0.6	4500				710	50	800
SVC 431D-20A	20			140.0	1.0	6500				710	100	1600
SVC 471D-05A	5			10.0	0.1	400				810	5	80
SVC 471D-07A	7			20.0	0.25	1200				775	10	170
SVC 471D-10A	10	300	385	45.0	0.4	2500	470	423	517	775	25	350
SVC 471D-14A	14			80.0	0.6	4500				775	50	700
SVC 471D-20A	20			150.0	1.0	6500				775	100	1400

Device Type	Chip Element Size	Maximum Ratings					Characteristics					
		Applied Voltage		Transient			Nominal Varistor ④ Peak Voltage		Max. Clamping ⑤ Voltage @ Test Current(8/20µs)		Typical Capacitance	
		RMS 50/60Hz (25°C)	DC (25°C)	Energy ②	Average Power Dissipation	Peak ③ Current (8/20µs)	Vnom (Volts)	Tolerance Min.(Volts) Max.(Volts)	Vc (Volts)	Ip (Amps)		
		Vacm (Volts)	Vdcm (Volts)	Wtm (Joules)	Ptam (Watts)	Itm (Amps)					f=1kHz (µF)	
SVC 561D-10A	10			45.0	0.4	2500			920	25	300	
SVC 561D-14A	14	350	460	85.0	0.6	4500	560	504	616	920	50	600
SVC 561D-20A	20			150.0	1.0	8000			920	100	1200	
SVC 621D-10A	10			45.0	0.4	2500			1025	25	270	
SVC 621D-14A	14	385	550	85.0	0.6	4500	620	558	682	1025	50	550
SVC 621D-20A	20			150.0	1.0	8000			1025	100	1100	
SVC 681D-10A	10			45.0	0.4	2500			1120	25	250	
SVC 681D-14A	14	420	560	90.0	0.6	4500	680	612	748	1120	50	500
SVC 681D-20A	20			160.0	1.0	8000			1120	100	1000	
SVC 751D-10A	10			50.0	0.4	2500			1240	25	220	
SVC 751D-14A	14	460	615	100.0	0.6	4500	750	675	825	1240	50	450
SVC 751D-20A	20			175.0	1.0	8000			1240	100	900	
SVC 781D-10A	10			50.0	0.4	2500			1290	25	220	
SVC 781D-14A	14	485	640	105.0	0.6	4500	780	702	858	1290	50	440
SVC 781D-20A	20			180.0	1.0	6500			1290	100	880	
SVC 821D-10A	10			55.0	0.4	2500			1355	25	210	
SVC 821D-14A	14	510	670	110.0	0.6	4500	820	738	902	1355	50	420
SVC 821D-20A	20			190.0	1.0	6500			1355	100	840	
SVC 911D-10A	10			60.0	0.4	2500			1500	25	180	
SVC 911D-14A	14	550	745	120.0	0.6	4500	910	819	1001	1500	50	380
SVC 911D-20A	20			215.0	1.0	6500			1500	100	750	
SVC 102D-10A	10			65.0	0.4	2500			1650	25	180	
SVC 102D-14A	14	625	825	130.0	0.6	4500	1000	900	1100	1650	50	350
SVC 102D-20A	20			230.0	1.0	6500			1650	100	700	
SVC 112D-10A	10			70.0	0.4	2500			1815	25	150	
SVC 112D-14A	14	680	895	140.0	0.6	4500	1100	990	1210	1815	50	300
SVC 112D-20A	20			250.0	1.0	6500			1815	100	600	
SVC 182D-14A	14	1000	1465	24.0	0.6	4500	1800	1620	1980	2970	50	200
SVC 182D-20A	20			400.0	1.0	6500			2970	100	400	

Notes :

- ① The waveform of the maximum DC applied voltage is flat. When a ripple voltage as from a rectifier source is supplied make sure that the peak voltage is kept under th Vdcm An AC applied voltage(50/60Hz) form a since waveshape. When the distortion in the waveform is extensive make sure that the peak voltage is less than $\sqrt{2}$ times the Vacm.
 - ② Energy : Wtm
Transient energy ratings are given in the Wtm column of the specifications in Joules(watt-second). The rating is the maximum allowable energy for a single impulse of 2ms square-waveform current with continuous voltage applied. Energy ratings are based on a shift of Vnom of less than $\pm 10\%$ of initial value.
 - ③ Transient peak current(Itm)
The peak current rating. Itm. of varistor is based on an 8/20 µs test impulse waveshape. This peak current is the maximum peak current in which the nominal varistor voltage shift does not exceed $\pm 10\%$ when the test impulse is applied once at 5 minutes intervals.
 - ④ Nominal varistor voltage : Vnom
Indicates the varistor terminal voltage measured with a 1mA DC applied. -0.1mA DC in the case of the 0.5A and 05B series.
 - ⑤ Maximum clamping voltage : Vc
Indicates the peak teminal voltage measured with an 8/20µs impulse current applied.
- Operating ambient temperature : -40°C to +80°C
 • Storage temperature : -40°C to +125°C
 • UL and CSA recognized(UL 1449, UL 497B or UL 1414, CSA)
 SVC varistors have been tested by Underwriter’s Laboratories, Inc. and Canadian Standards Association
 UL File No. E97754, E151195, E154171.
 CSA File No. LR78923.

Dimensions

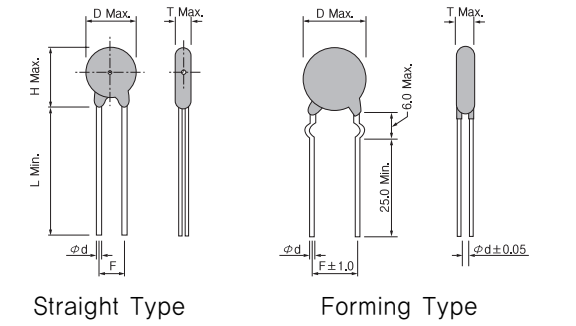

B Type

Type	T Max.	D Max.	H Max.	L Min.	F	Ød
SVC 180D-05B	4.5	7.5	10.0	25	5.0	0.50
SVC 220D-05B	4.5	7.5	10.0	25	5.0	0.50
SVC 270D-05B	4.5	7.5	10.0	25	5.0	0.50
SVC 330D-05B	4.5	7.5	10.0	25	5.0	0.50
SVC 390D-05B	4.5	7.5	10.0	25	5.0	0.50
SVC 470D-05B	4.5	7.5	10.0	25	5.0	0.50
SVC 560D-05B	4.5	7.5	10.0	25	5.0	0.50
SVC 680D-05B	4.5	7.5	10.0	25	5.0	0.50
SVC 180D-07D	4.5	9.0	10.0	25	5.0	0.50
SVC 220D-07D	4.5	9.0	10.0	25	5.0	0.50
SVC 270D-07D	4.5	9.0	10.0	25	5.0	0.50
SVC 330D-07D	4.5	9.0	10.0	25	5.0	0.50
SVC 390D-07D	4.5	9.0	10.0	25	5.0	0.50
SVC 470D-07D	4.5	9.0	10.0	25	5.0	0.50
SVC 560D-07D	4.5	9.0	10.0	25	5.0	0.50
SVC 680D-07D	4.5	9.0	10.0	25	5.0	0.50
SVC 180D-10B	5.0	13.5	16.5	25	7.5	0.70
SVC 220D-10B	5.0	13.5	16.5	25	7.5	0.70
SVC 270D-10B	5.0	13.5	16.5	25	7.5	0.70
SVC 330D-10B	5.0	13.5	16.5	25	7.5	0.70
SVC 390D-10B	5.0	13.5	16.5	25	7.5	0.70
SVC 470D-10B	5.0	13.5	16.5	25	7.5	0.70
SVC 560D-10B	5.0	13.5	16.5	25	7.5	0.70
SVC 680D-10B	5.0	13.5	16.5	25	7.5	0.70
SVC 180D-14B	5.0	17.0	20.0	25	7.5	0.70
SVC 220D-14B	5.0	17.0	20.0	25	7.5	0.70
SVC 270D-14B	5.0	17.0	20.0	25	7.5	0.70
SVC 330D-14B	5.0	17.0	20.0	25	7.5	0.70
SVC 390D-14B	5.0	17.0	20.0	25	7.5	0.70
SVC 470D-14B	5.0	17.0	20.0	25	7.5	0.70
SVC 560D-14B	5.0	17.0	20.0	25	7.5	0.70
SVC 680D-14B	5.0	17.0	20.0	25	7.5	0.70
SVC 180D-20B	6.0	23.0	27.0	30	10.0	0.80
SVC 220D-20B	6.0	23.0	27.0	30	10.0	0.80
SVC 270D-20B	6.0	23.0	27.0	30	10.0	0.80
SVC 330D-20B	6.0	23.0	27.0	30	10.0	0.80
SVC 390D-20B	6.0	23.0	27.0	30	10.0	0.80
SVC 470D-20B	6.0	23.0	27.0	30	10.0	0.80
SVC 560D-20B	6.0	23.0	27.0	30	10.0	0.80
SVC 680D-20B	6.0	23.0	27.0	30	10.0	0.80

Type	T Max.	D Max.	H Max.	L Min.	F	Ød
SVC 820D-05A	4.5	7.0	10.0	25	5.0	0.50
SVC 101D-05A	4.5	7.0	10.0	25	5.0	0.50
SVC 121D-05A	4.5	7.0	10.0	25	5.0	0.50
SVC 151D-05A	4.5	7.0	10.0	25	5.0	0.50
SVC 201D-05A	4.5	7.0	10.0	25	5.0	0.50
SVC 221D-05A	4.5	7.0	10.0	25	5.0	0.50
SVC 241D-05A	4.5	7.0	10.0	25	5.0	0.50
SVC 271D-05A	4.5	7.0	10.0	25	5.0	0.50
SVC 361D-05A	5.0	7.0	10.0	25	5.0	0.50
SVC 391D-05A	5.0	7.0	10.0	25	5.0	0.50
SVC 431D-05A	6.0	7.0	10.0	25	5.0	0.50

A Type

Type	T Max.	D Max.	H Max.	L Min.	F	Ød
SVC 471D-05A	6.0	7.0	10.0	25	5.0	0.50
SVC 820D-07A	4.5	9.0	12.0	25	5.0	0.50
SVC 101D-07A	4.5	9.0	12.0	25	5.0	0.50
SVC 121D-07A	4.5	9.0	12.0	25	5.0	0.50
SVC 151D-07A	4.5	9.0	12.0	25	5.0	0.50
SVC 201D-07A	4.5	9.0	12.0	25	5.0	0.50
SVC 221D-07A	4.5	9.0	12.0	25	5.0	0.50
SVC 241D-07A	4.5	9.0	12.0	25	5.0	0.50
SVC 271D-07A	4.5	9.0	12.0	25	5.0	0.50
SVC 361D-07A	5.0	9.0	12.0	25	5.0	0.50
SVC 391D-07A	5.0	9.0	12.0	25	5.0	0.50
SVC 431D-07A	6.0	9.0	12.0	25	5.0	0.50
SVC 471D-07A	6.0	9.0	12.0	25	5.0	0.50
SVC 820D-10A	4.5	14.0	17.0	25	7.5	0.70
SVC 101D-10A	4.5	14.0	17.0	25	7.5	0.70
SVC 121D-10A	4.5	14.0	17.0	25	7.5	0.70
SVC 151D-10A	4.5	14.0	17.0	25	7.5	0.70
SVC 201D-10A	4.5	14.0	17.0	25	7.5	0.70
SVC 221D-10A	4.5	14.0	17.0	25	7.5	0.70
SVC 241D-10A	4.5	14.0	17.0	25	7.5	0.70
SVC 271D-10A	4.5	14.0	17.0	25	7.5	0.70
SVC 361D-10A	5.0	14.0	17.0	25	7.5	0.70
SVC 391D-10A	5.0	14.0	17.0	25	7.5	0.70
SVC 431D-10A	6.0	14.0	17.0	25	7.5	0.70
SVC 561D-10A	7.5	14.0	17.0	25	7.5	0.70
SVC 621D-10A	7.5	14.0	17.0	25	7.5	0.70
SVC 681D-10A	7.5	14.0	17.0	25	7.5	0.70
SVC 751D-10A	8.5	14.0	17.0	25	7.5	0.70
SVC 781D-10A	8.5	14.0	17.0	25	7.5	0.70
SVC 821D-10A	8.5	14.0	17.0	25	7.5	0.70
SVC 911D-10A	10.5	14.0	17.0	25	7.5	0.70
SVC 102D-10A	10.5	14.0	17.0	25	7.5	0.70
SVC 112D-10A	10.5	14.0	17.0	25	7.5	0.70
SVC 820D-14A	4.5	17.5	21.0	25	7.5	0.70
SVC 101D-14A	4.5	17.5	21.0	25	7.5	0.70
SVC 121D-14A	4.5	17.5	21.0	25	7.5	0.70
SVC 151D-14A	4.5	17.5	21.0	25	7.5	0.70
SVC 201D-14A	4.5	17.5	21.0	25	7.5	0.70
SVC 221D-14A	4.5	17.5	21.0	25	7.5	0.70
SVC 241D-14A	4.5	17.5	21.0	25	7.5	0.70
SVC 271D-14A	4.5	17.5	21.0	25	7.5	0.70
SVC 361D-14A	5.0	17.5	21.0	25	7.5	0.70
SVC 391D-14A	5.0	17.5	21.0	25	7.5	0.70
SVC 431D-14A	6.0	17.5	21.0	25	7.5	0.70
SVC 471D-14A	6.0	17.5	21.0	25	7.5	0.70
SVC 561D-14A	7.5	17.5	21.0	25	7.5	0.70
SVC 621D-14A	7.5	17.5	21.0	25	7.5	0.70
SVC 681D-14A	7.5	17.5	21.0	25	7.5	0.70
SVC 751D-14A	8.5	17.5	21.0	25	7.5	0.70
SVC 781D-14A	8.5	17.5	21.0	25	7.5	0.70
SVC 821D-14A	8.5	17.5	21.0	25	7.5	0.70
SVC 911D-14A	10.5	17.5	21.0	25	7.5	0.70
SVC 102D-14A	10.5	17.5	21.0	25	7.5	0.70
SVC 112D-14A	10.5	17.5	21.0	25	7.5	0.70
SVC 182D-14A	15.0	17.5	21.0	25	7.5	0.70
SVC 820D-20A	4.5	23.0	28.0	30	10.0	0.70
SVC 101D-20A	4.5	23.0	28.0	30	10.0	0.70
SVC 121D-20A	4.5	23.0	28.0	30	10.0	0.70
SVC 151D-20A	4.5	23.0	28.0	30	10.0	0.70
SVC 201D-20A	4.5	23.0	28.0	30	10.0	0.70
SVC 221D-20A	4.5	23.0	28.0	30	10.0	0.70
SVC 241D-20A	4.5	24.0	28.0			

FS5 Type

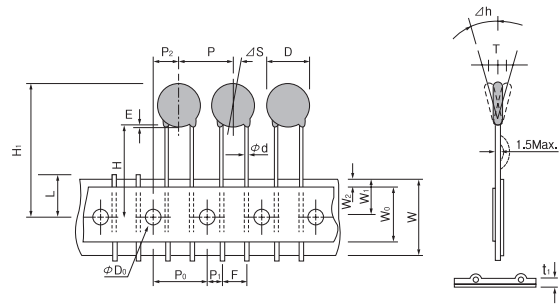

FK5 Type

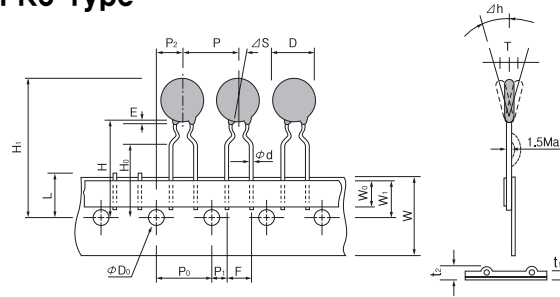

FF9 Type

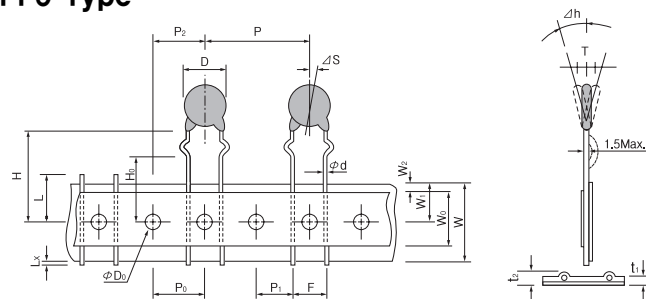

FF7 Type

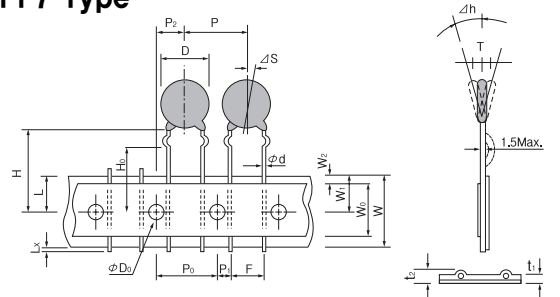

FF8 Type

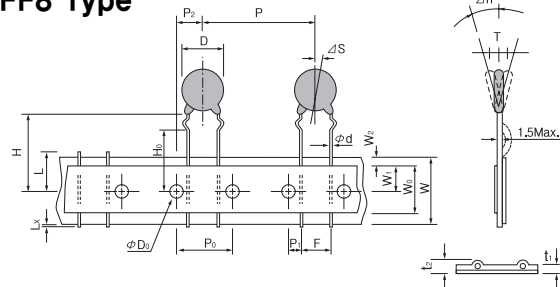

Item	Code	Dimensions(mm)	
		FS5 or FK5	FF9
Body Diameter	D	See page 119	
Body Thickness	T	See page 119	
Lead Diameter	φd	0.5/0.50±0.05	0.6-0.8±0.05
Pitch of sprocket Hole	P ₀	12.7±0.3	
Pitch of Component	P	6.35±1.3	25.4±1.0
Lead Length from Hole Center Lead	P ₁	3.85±0.7	8.95±1.0
Lead Length from Hole Center to Component Center	P ₂	6.35±1.3	12.7±1.5
Lead Spacing	F	5.0 ^{+0.8} _{-0.2}	7.5±1.0
Deviation Along Tape. Left or Right	ΔS	0±1.0	
Deviation Across Tape	Δh	0±2.0	
Carrier Tape Width	W	18.0 ^{+1.0} _{-0.5}	
Hold Down Tape Width	W ₀	5.0Min.	9.0Min.
Position of Sprocket Hole	W ₁	9.0±0.5	
Hole Down Tape Position	W ₂	3.0Max.	
Lead-Wire Clinch Height	H ₀	16.0±0.5	
Height of Component Hole	H	20.0 ^{+1.5} _{-1.0}	
Component Height	H _i	32.25Max.	
Diameter of Sprocket Hole	φD ₀	4.0±0.2	
Length of Snipped Lead	L	11.0Max.	
Total Tape Thickness	t ₁	0.7±0.2	
Total Thickness Tape and Lead Wire	t ₂	1.5Max.	1.7Max.
Length of Snipped Lead	Lx	1.0Max.	

Item	Code	Dimensions(mm)	
		FF7	FF8
Body Diameter	D	See page 119	
Body Thickness	T	See page 119	
Lead Diameter	φd	0.6-0.8±0.05	
Pitch of sprocket Hole	P ₀	15.0±0.3	
Pitch of Component	P	15.0±0.3	30.0±1.0
Lead Length from Hole Center Lead	P ₁	3.75±1.0	
Lead Length from Hole Center to Component Center	P ₂	7.50±1.5	
Lead Spacing	F	7.5±1.0	
Deviation Along Tape. Left or Right	ΔS	0±1.0	
Deviation Across Tape	Δh	0±2.0	
Carrier Tape Width	W	18.0 ^{+1.0} _{-0.5}	
Hold Down Tape Width	W ₀	5.0Min.	
Position of Sprocket Hole	W ₁	9.0±0.5	
Hole Down Tape Position	W ₂	3.0Max.	
Lead-Wire Clinch Height	H ₀	16.0±0.5	
Height of Component Hole	H	20.0 ^{+1.5} _{-1.0}	
Component Height	H _i	40.00Max.	
Diameter of Sprocket Hole	φD ₀	4.0±0.2	
Length of Snipped Lead	L	11.0Max.	
Total Taps Thickness	t ₁	0.7±0.2	
Total Thickness Tape and Lead Wire	t ₂	1.7Max.	
Length of Snipped Lead	Lx	1.0Max.	

Char, Curves and Lifetime

Transient V-I Charactic Curves

Current waveform under 10² A : DC
over 10¹ A : 8/20μs

05B(SVC 180D-05B to SVC 680D-05B)

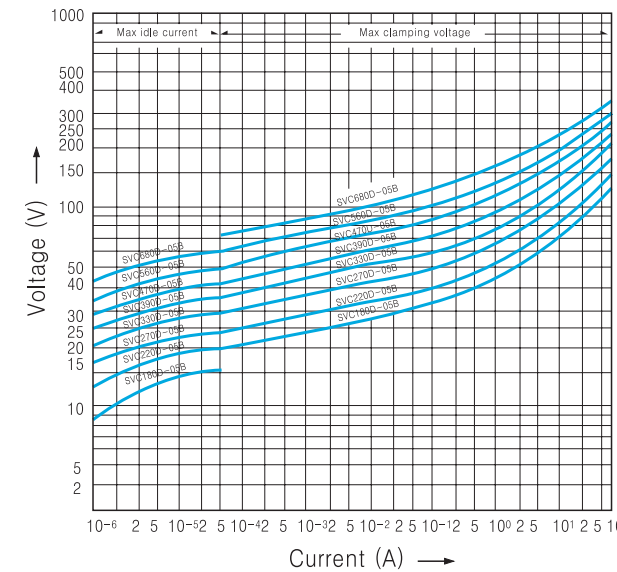

Pulse Lifetime Ratings

Notes : 2-pulse : 5-minute interval
3 to 10-pulse : 2-minute interval
Up to 10⁶ - pulse : 10-second interval

05B(SVC 180D-05B to SVC 680D-05B)

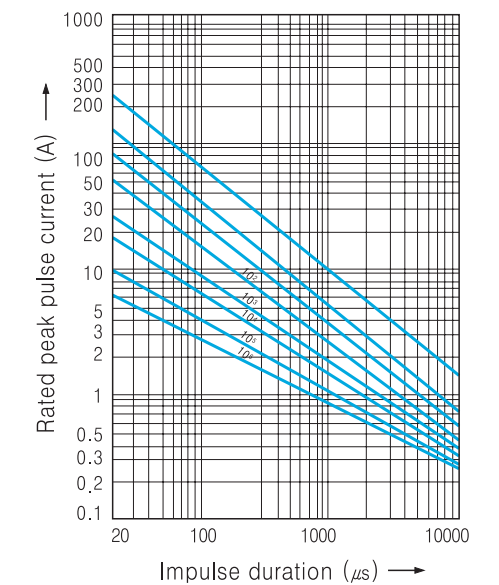

05A(SVC 820D-05A to SVC 471D-05A)

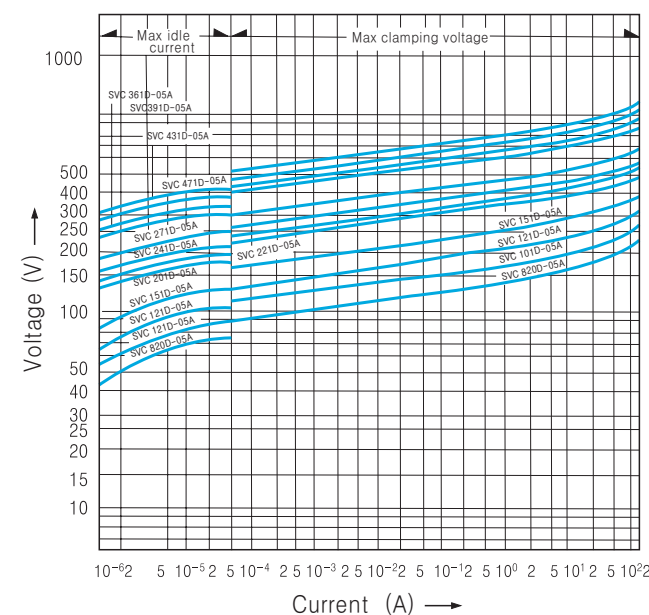

05A(SVC 820D-05A to SVC 471D-05A)

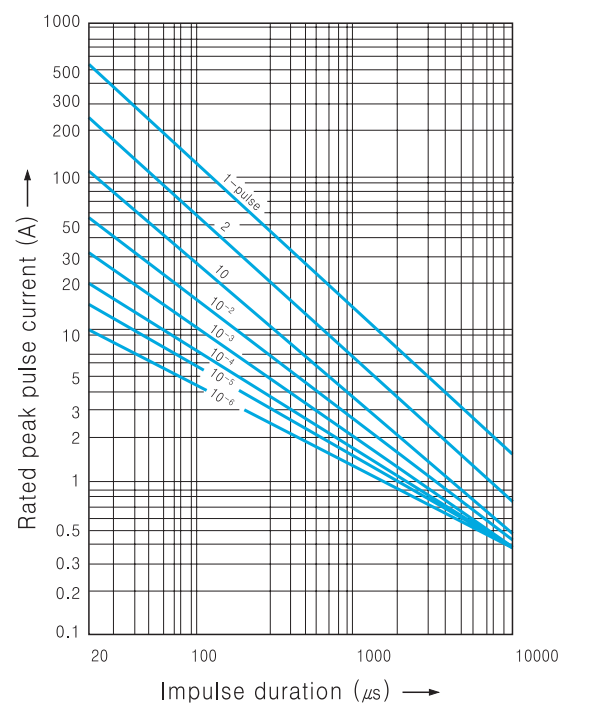

Transient V-I Characteristic Curves

Current waveform under 10^2 A : DC
over 10^{-1} A : $8/20\mu s$

07B(SVC 180D-07B to SVC 680D-07B)

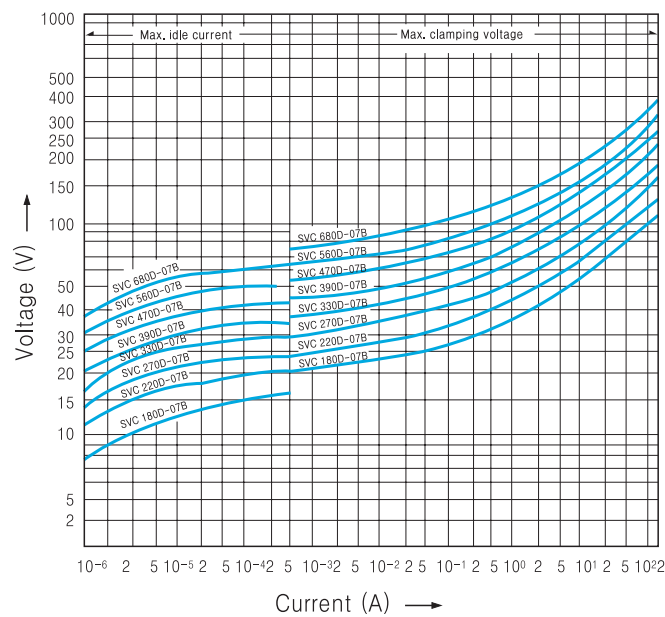

Pulse Lifetime Ratings

Notes : 2-pulse : 5-minute interval
3 to 10-pulse : 2-minute interval
Up to 10^6 -pulse : 10-second interval

07B(SVC 180D-07B to SVC 680D-07B)

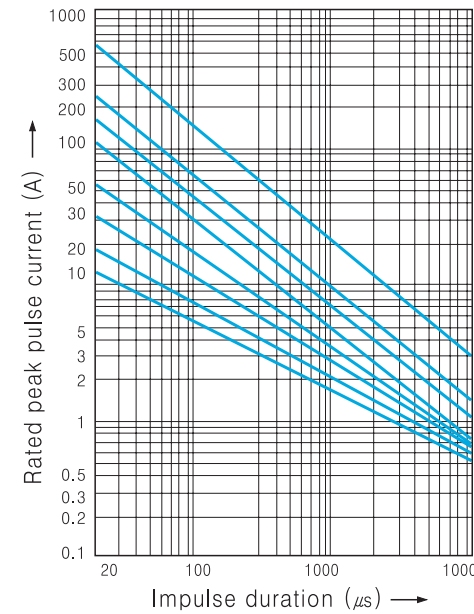

Transient V-I Characteristic Curves

Current waveform under 10^2 A : DC
over 10^{-1} A : $8/20\mu s$

10B(SVC 180D-10B to SVC 680D-10B)

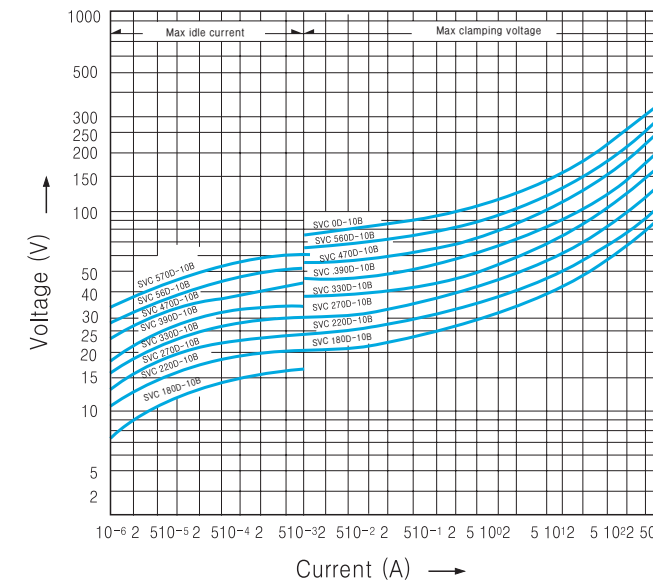

Pulse Lifetime Ratings

Notes : 2-pulse : 5-minute interval
3 to 10-pulse : 2-minute interval
Up to 10^6 -pulse : 10-second interval

10B(SVC 180D-10B to SVC 680D-10B)

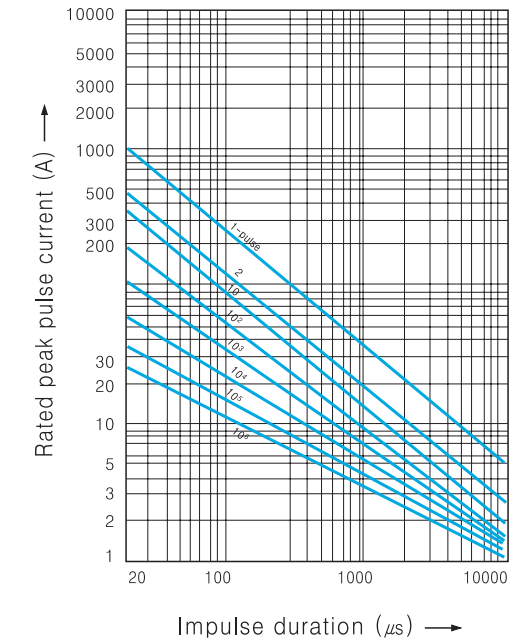

07A(SVC 820D-07A to SVC 471D-07A)

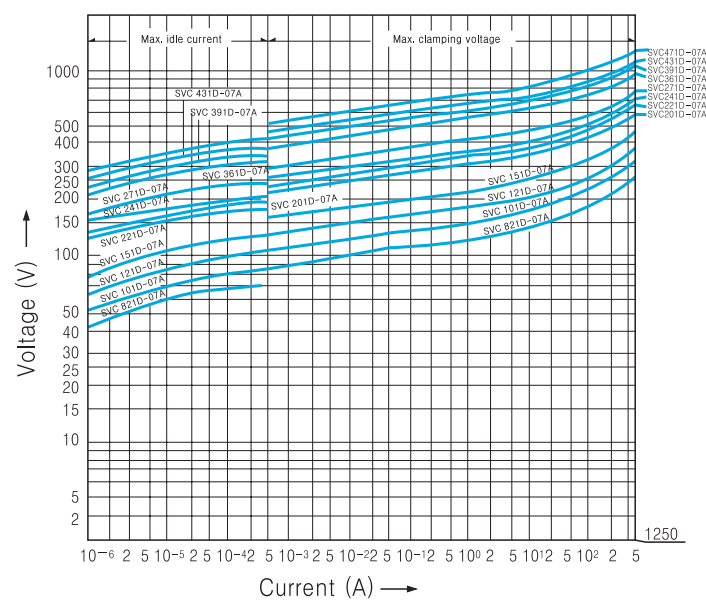

07A(SVC 820D-07A to SVC 471D-07A)

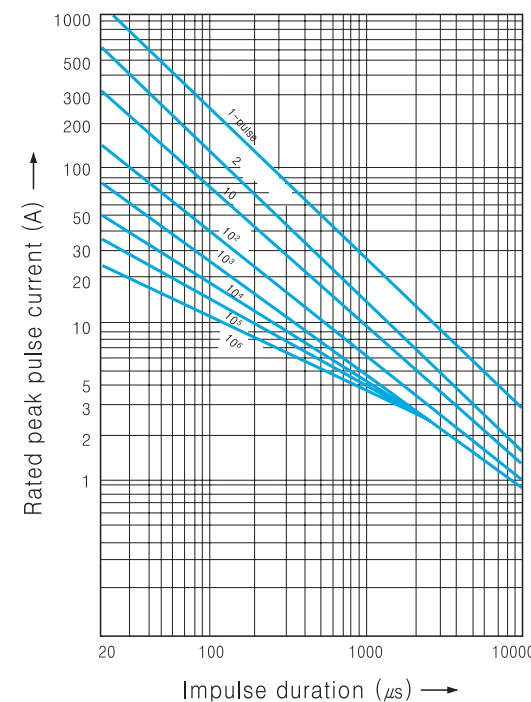

10A(SVC 820D-10A to SVC 471D-10A)

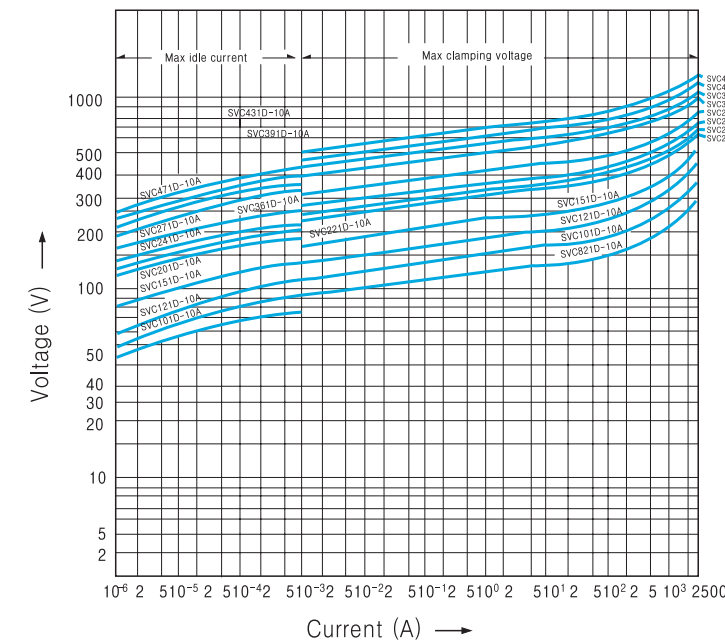

10A(SVC 820D-10A to SVC 471D-10A)

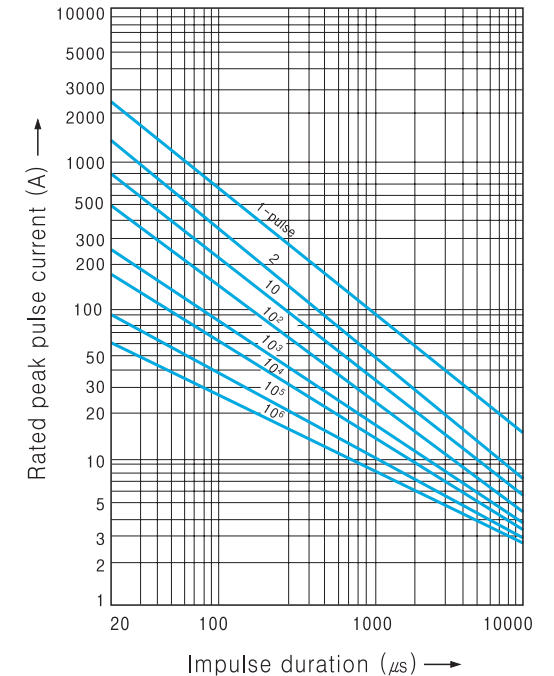

Transient V-I Characteristic Curves

Current waveform under 10^2 A : DC
over 10^1 A : $8/20\mu s$

10A(SVC 561D-10A to SVC 112D-10A)

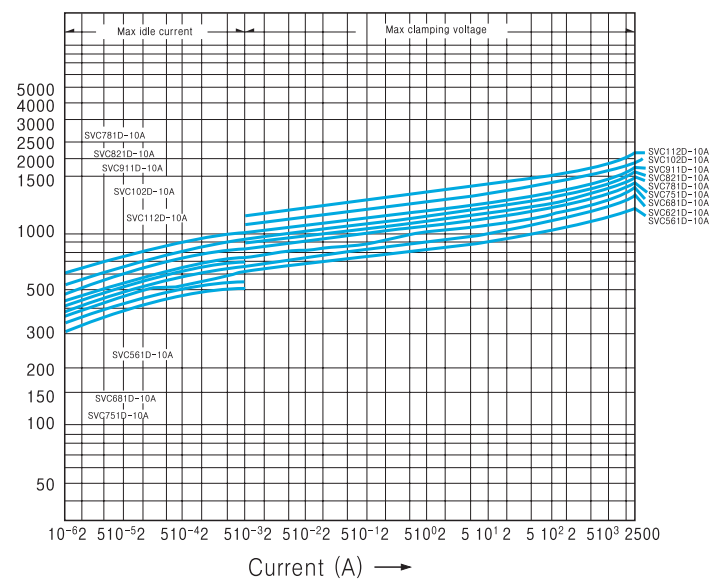

Pulse Lifetime Ratings

Notes : 2-pulse : 5-minute interval
3 to 10-pulse : 2-minute interval
Up to 10^6 -pulse : 10-second interval

10A(SVC 561D-10A to SVC 112D-10A)

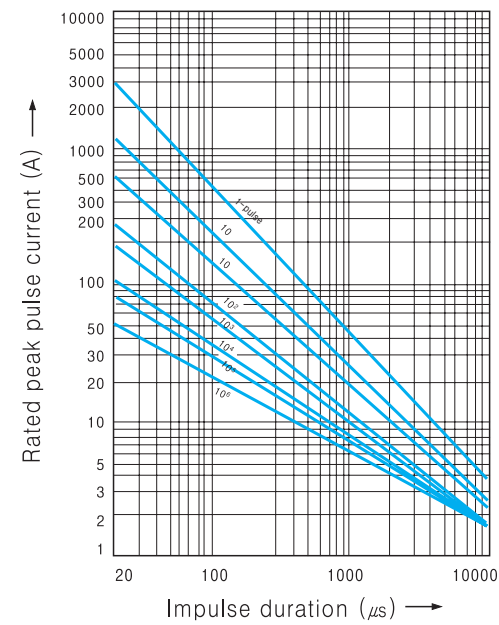

Transient V-I Characteristic Curves

Current waveform under 10^2 A : DC
over 10^1 A : $8/20\mu s$

14A(SVC 820D-14A to SVC 471D-14A)

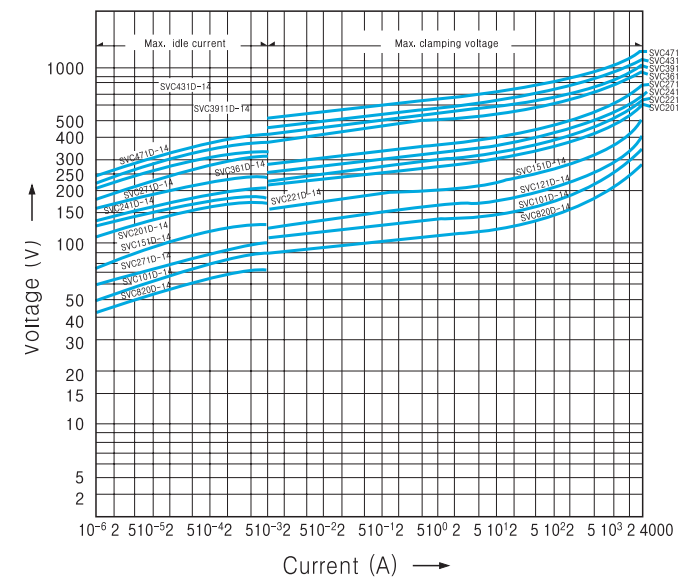

Pulse Lifetime Ratings

Notes : 2-pulse : 5-minute interval
3 to 10-pulse : 2-minute interval
Up to 10^6 -pulse : 10-second interval

14A(SVC 820D-14A to SVC 471D-14A)

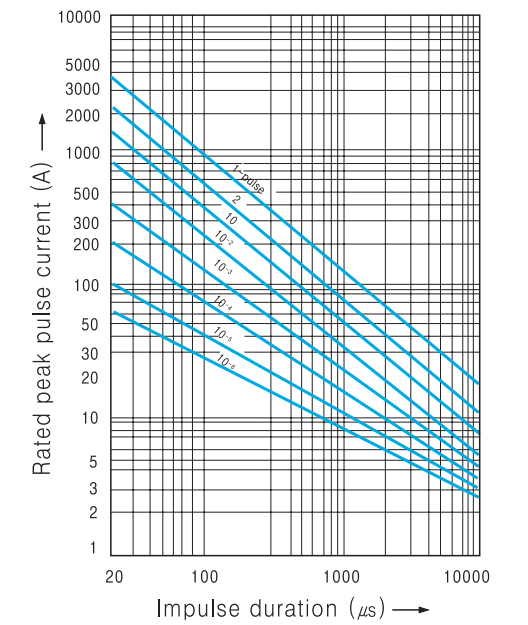

14B(SVC 180D-14B to ENC 680D-14B)

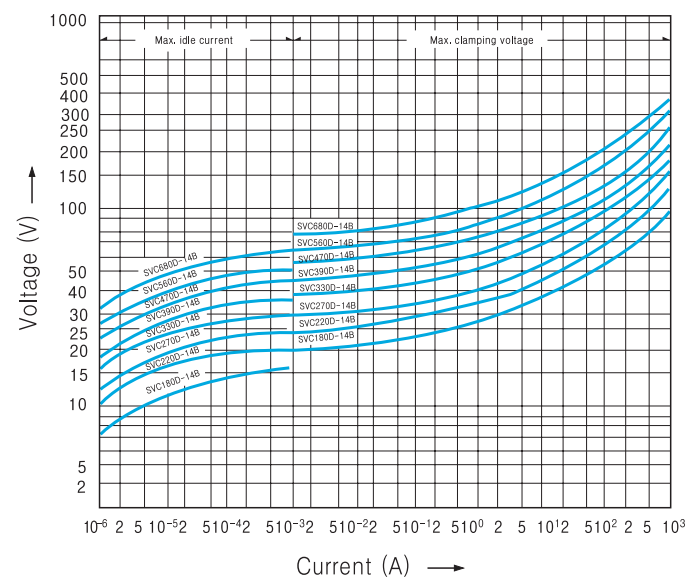

14B(SVC 180D-14B to SVC 680D-14B)

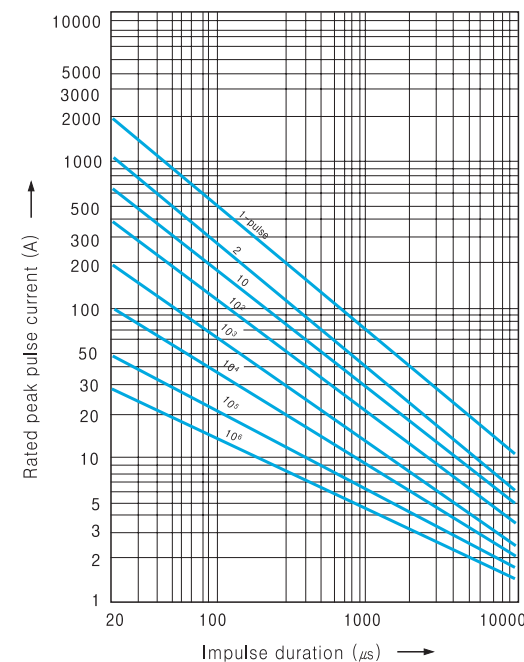

14A(SVC 561D-14A to SVC 182D-14A)

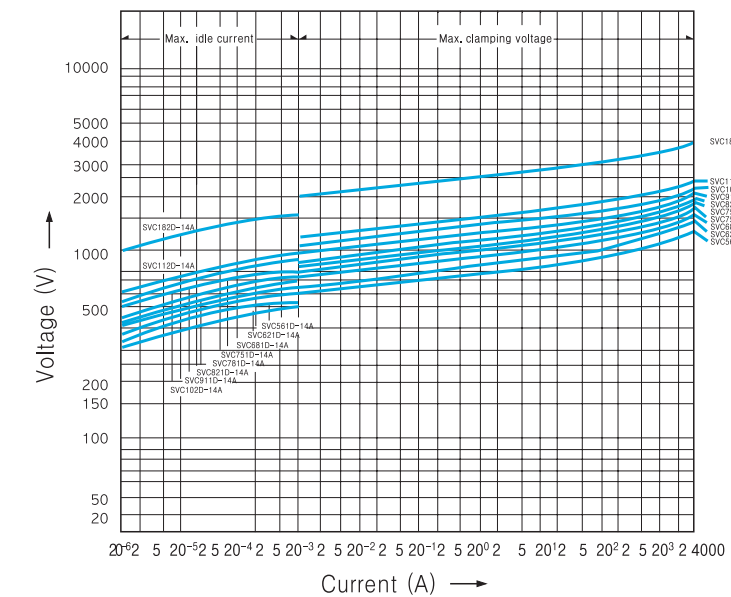

14A(SVC 561D-14A to SVC 182D-14A)

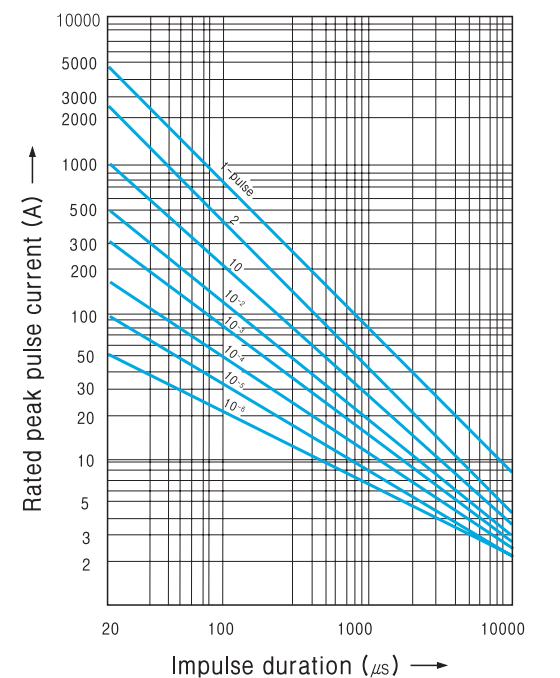

Transient V-I Characteristic Curves

Current waveform under 10^{-2} A : DC
over 10^{-1} A : $8/20\mu s$

20B(SVC 180D-20B to SVC 680D-20B)

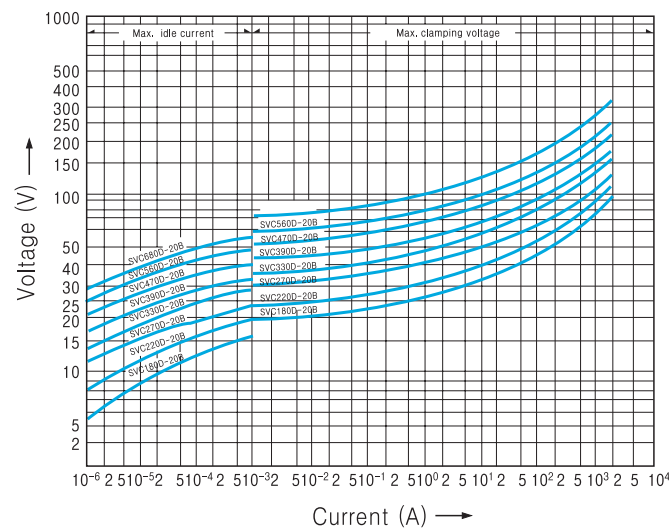

Pulse Lifetime Ratings

Notes : 2-pulse : 5-minute interval
3 to 10-pulse : 2-minute interval
Up to 10^6 -pulse : 10-second interval

20B(SVC 180D-20B to SVC 680D-20B)

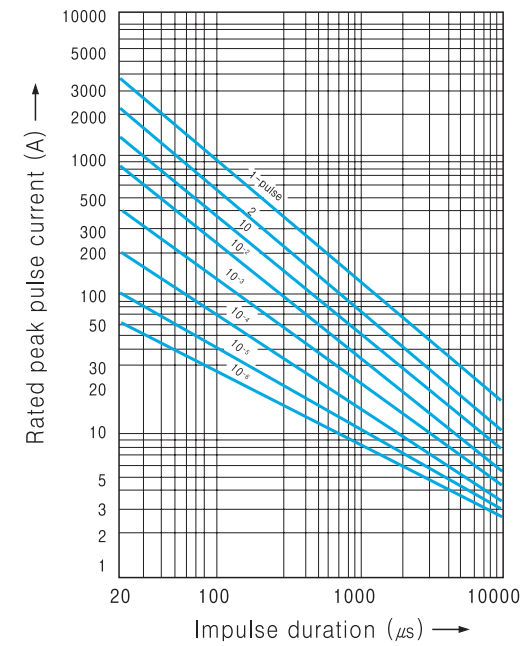

Transient V-I Characteristic Curves

Current waveform under 10^{-2} A : DC
over 10^{-1} A : $8/20\mu s$

20A(SVC 561D-20A to SVC 182D-20A)

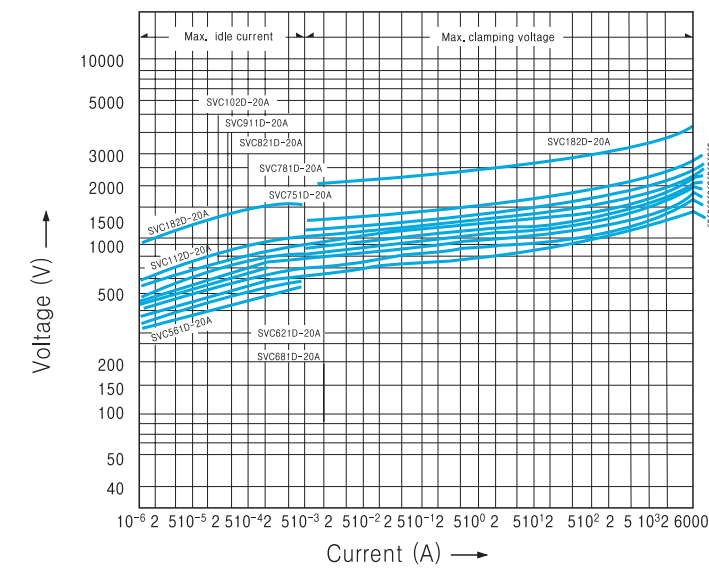

Pulse Lifetime Ratings

Notes : 2-pulse : 5-minute interval
3 to 10-pulse : 2-minute interval
Up to 10^6 -pulse : 10-second interval

20A(SVC 561D-20A to SVC 182D-20A)

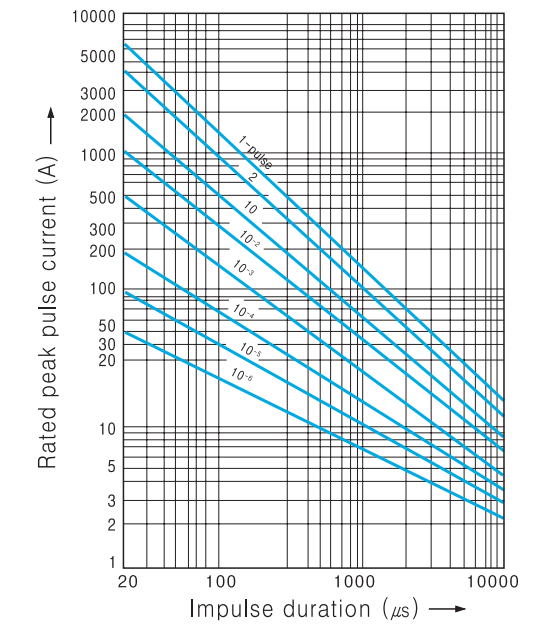

20A(SVC 820D-20A to SVC 471D-20A)

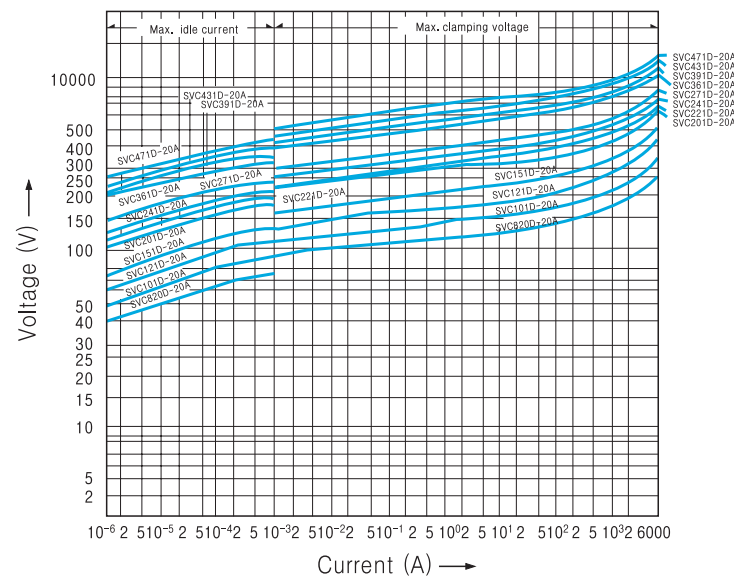

20A(SVC 820D-20A to SVC 471D-20A)

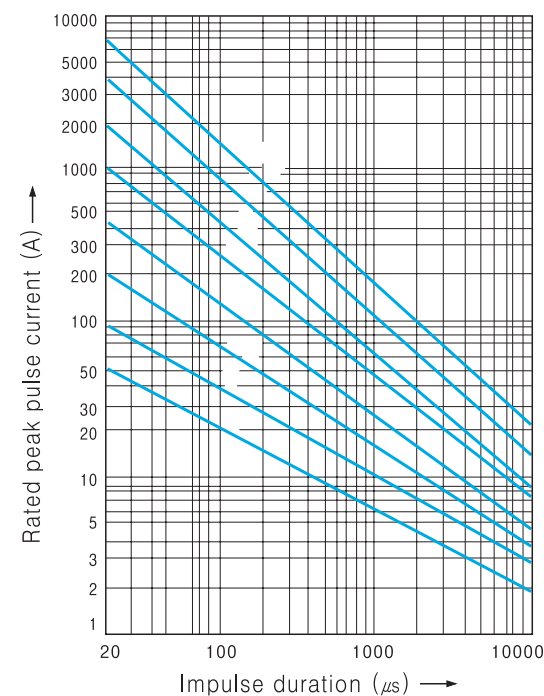

Applications

- The Protection of semiconducting elements such as diodes, thyristors, transistors, IC and relays against transient Voltages.
- Similar protection of many types of measuring instruments, control machinery and communication equipment and broadcasting equipment against inductive lightning and switching surges.
- Protection of general purpose electrical equipment, domestic machinery and appliances. TV and radios and similar consumer products against lightning and switching surges.

Power Supply Circuit Protection

Line circuit

Varistor voltage selection table (Z₁)

Power Supply Voltage	Type
100V AC	SVC201D - □ □ A
	SVC221D - □ □ A
	SVC241D - □ □ A
	SVC271D - □ □ A*
200V AC	SVC391D - □ □ A
	SVC431D - □ □ A
	SVC471D - □ □ A*
12V DC	SVC220D - □ □ B
24V DC	SVC390D - □ □ B

Notes :

- ① The power supply voltage must not exceed the maximum allowable circuit voltage.
- ② Since independent wiring loads and capacitive loads cause the voltage build-up at the time of opening or closing the load, use SVC having a varistor voltage as high as possible. (*mark)
- ③ The bold faced portions of the type letters vary.

AC/DC single-phase circuit

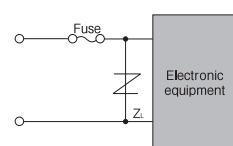

AC three-phase circuit

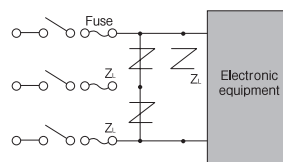

Line and ground circuit

Varistor voltage selection table(Z_ε)

Power Supply Voltage	Type
100V AC	SVC431D - □ □ A SVC471D - □ □ A
200V AC	SVC751D - □ □ A to SVC112D - □ □ A* SVC182D - □ □ A**

Notes :

- ① When subjected to megger testing(500V DC), the insulation resistance value can decrease due to the leakage current of the SVC. To avoid this remove the varistor or use* marked SVC.
 - ② When subjected to dielectric strength test(1000V AC). remove the SVC or use** marked SVC.
- Select varistors taking a note of operating conditions peculiar to the equipment.

AC/DC

single-phase circuit

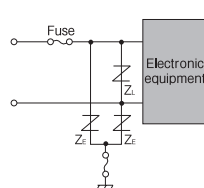

AC

three-phase circuit

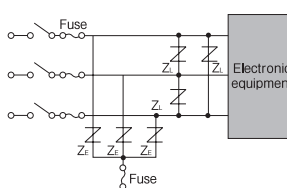

Telecommunication Circuit Protection

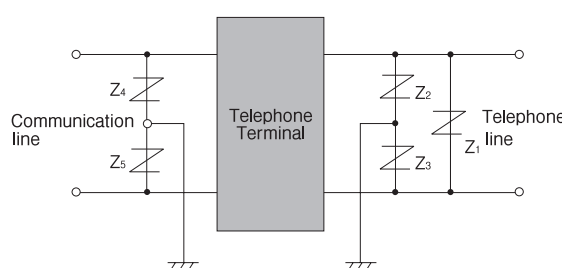

Varistor voltage selection guided

Power Supply Voltage	Type
12V DC	SVC180D - □ □ B
	SVC220D - □ □ B
	SVC820D - □ □ A
24V AC	SVC390D - □ □ B
	SVC820D - □ □ A

Notes :

The varistor SVC has a capacitance value. Take not of this when applying them to high-frequency signal circuits.

Switching Circuit Protection

Protection of relay (Contact coil)

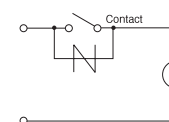
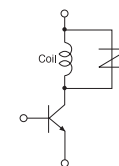

Protection of semiconductors

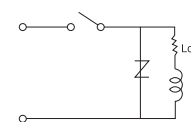
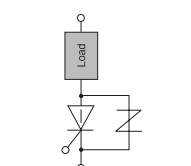

Varistor voltage selection guide

Power Supply Voltage	Type
12V DC	SVC220D - □ □ B
24V DC	SVC390D - □ □ B
100V DC	SVC151D - □ □ A
100V AC	SVC201D - □ □ A
	SVC221D - □ □ A
	SVC241D - □ □ A
	SVC271D - □ □ A

Notes :

- ① The power supply voltage must not exceed the maximum allowable circuit voltage of the SVC
- ② Pay due attention to the surge energy generated by the load.
- ③ Select SVC referring to the pulse lifetime rating.
- ④ To further reduce the tendency of sparking across the contacts connect a capacitors parallel with the SVC. This will also protect the equipment from electromagnetic wave jamming.

Application Notes

Overcurrent protection

When surges exceed the rating for the SVC, short-circuits or damages can be expected. Take following precautions.

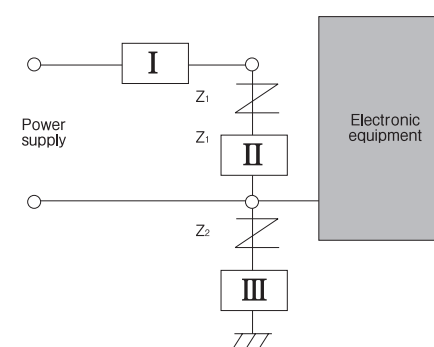

- ① Connect the SVC at a position nearer to the equipment than the overcurrent protection device "I" (fuse, MCCB) as is shown in the diagram. When the SVC is shorted, the overcurrent protection device "I" operates (trips or blow off the fuse).
- ② If the overcurrent protection device "I" can not be installed in "I" position, connect a fuse at "II" position. Select fuse rated current for the SVC referring to the following table.

SVC	05A	07A	10A	14A	20A
	05B	07B	10B	14B	20B
Applicable fuse rated current(A)	1 to 2	2 to 3	3 to 5	3 to 10	5 to 15

- ③ When "Z₂" SVC is connected between the equipment and ground install an ELCB (Earth Leakage Circuit Breaker). If not possible, connect a fuse or thermal fuse at "III" position.

Installation

- ① When operated at location near heating element or exposed to direct sun light, confirm that the ambient temperature range.
- ② When operated in dusty or dirty locations, or exposed to corrosive atmospheres, or where metallic powders or salt can be expected, be sure to mount within a protective enclosure.

Molding

When shielding the SVC in a resin molding, take a note of the materials used and temperature, since they influence the reliability. For further information please contact SAMWHA

Current, power and energy rating vs, temperature

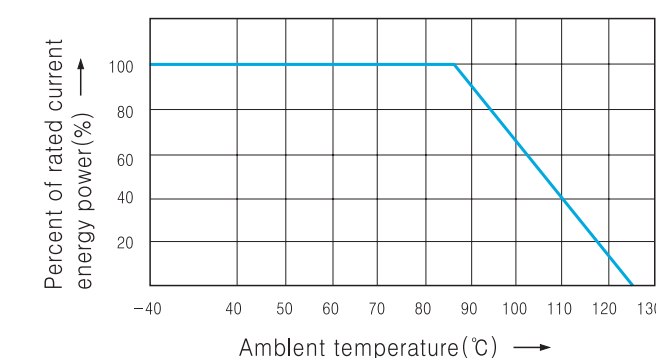

Electrical Characteristics

Operating ambient temperature	-40°C to +85°C
Storage temperature	-40°C to +125°C
Voltage temperatur coefficient	-0.05% °C
Insulation resistance(at500V)	Over 1000MΩ

Recognized standards

Standard	Date	Content	Applicable SVC series	File No.	
UL	UL 1449	Transient Voltage surge suppressors	Cord connected and Direct Plug in Type Equipment	05Series, 07Series, 10Series 14Series, 20Series	E151195
	UL 497B		02. 06	Protectors for data communication and fire alarm circuit	
CAS	C22.2 NO.1-M 1981	Varistor for Across - The - Line use as transient protection on 120Vac system	250V AC	SVC 201D - □ ~ SVC 182D -□	LR78923
VDE	02. 05. 16	Surge Suppression	SVC 180 - □ -SVC 112D -14		4000153
	02. 05. 16				40001516
	99. 08. 25				116012
ISO 9001:2000	94. 12. 15				ID03/0294

Application Exampel

Fire Alarm System

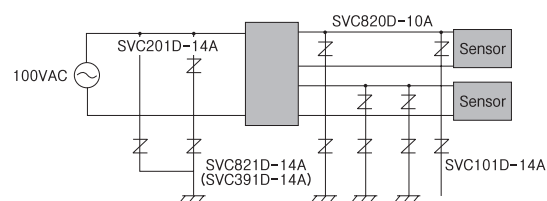

Stove, Boiler

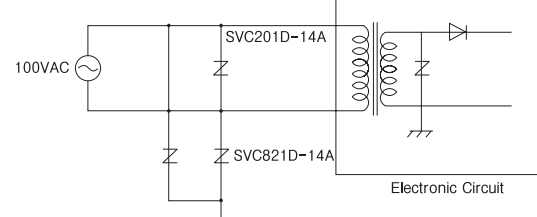

Traffic Signal Control

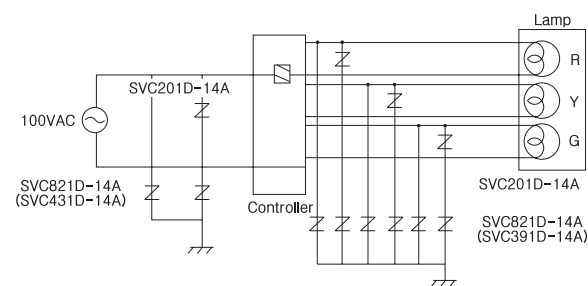

Vending Machine

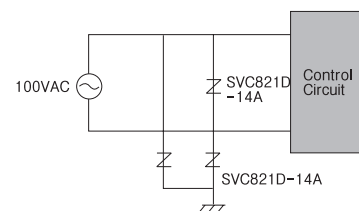

Solenoid

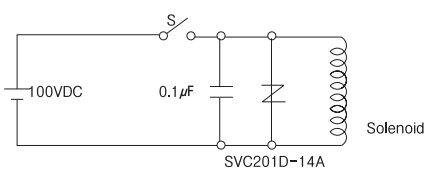

Brake, Clutch

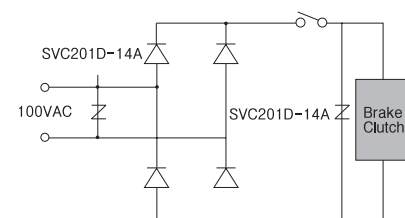

Contact Protection

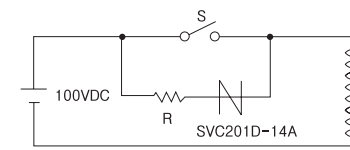

Thyrister Protection

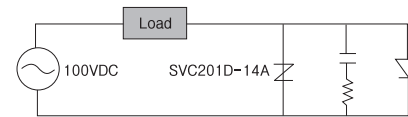

TV Booster

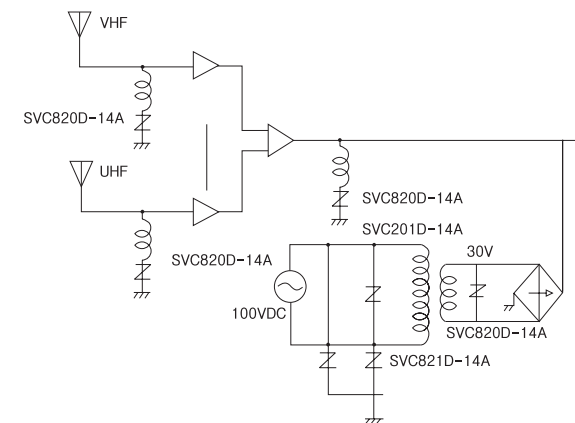

Microwave Oven

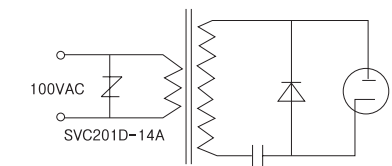

Triac Protection

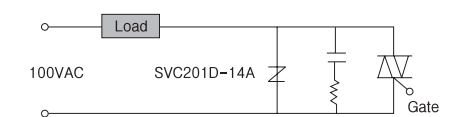

Sound Output Circuit

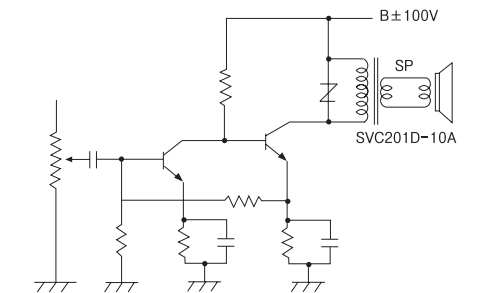

Varistor Terminology

Varistor Voltage : Vnom

Varistor peak terminal voltage measured with a specified current applied. The DC current applied is 1mA normally.

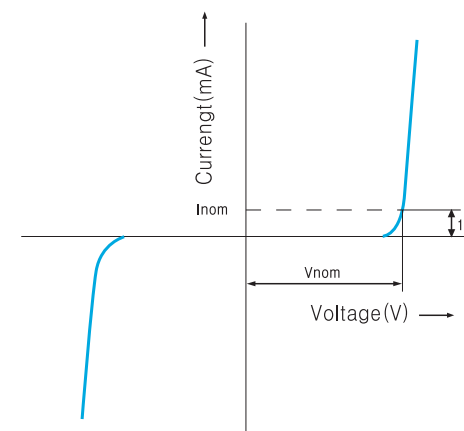

Clamping Voltage : Vc

Maximum terminal voltage (peak voltage across the varistor) measured with an applied 8/20µs impulse of a given peak current.

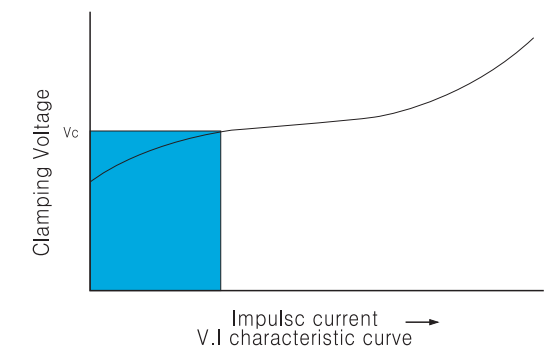

Capacitance

Typical values measured at a test frequency of 1kHz

Rated peak transient current : itm

Maximum peak current through the varistor with line voltage applied.

The maximum peak current with in the varistor voltage change ratio of $\pm 10\%$ with the standard $8/20\mu s$ impulse current applied two times at 5 minute interval.

Rated transient energy : Wtm

Maximum allowable energy for a single impulse of 2ms square-wave current waveform with rated continuous voltage applied. Maximum energy rating base on a shift of V_{nom} of less than $\pm 10\%$ of initial value.

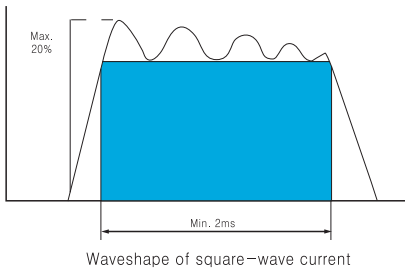

Pulse lifetime rating

This is expressed as the maximum allowable number of impulse currents applied.

$8/20\mu s$ impulse current(or 2ms square wave) is applied at prescribed interval.

This curve also provides for derating current as required with repetitive pulsing.

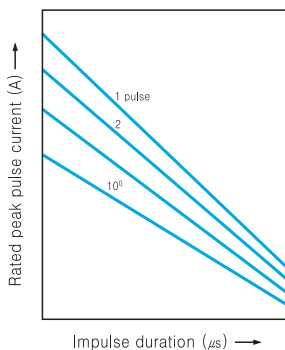

Test current waveform

Characteristics tests for Varistors are carried out by using $8/20\mu s$ test impulses Data such as the maximum clamping voltage(V_c)and the transient peak current(I_{tm}) are obtained by using this impulse current

However, for the V_c characteristics of the Axial Package type a 10mA DC squarewave current is used to carry out the test.

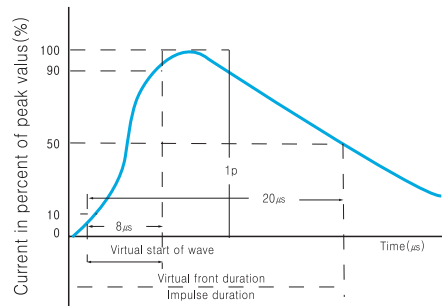

Rated RMS Voltage : Vacm

Maximum continuous sinusoidal RMS voltage at 50/60Hz which may be applied.

Rated DC Voltage : Vdcm

Maximum continuous DC voltage which may be applied.

Rated average power dissipation : Ptam

Maximum average power that can be applied within the specified ambient temperature.