

EC32 Series

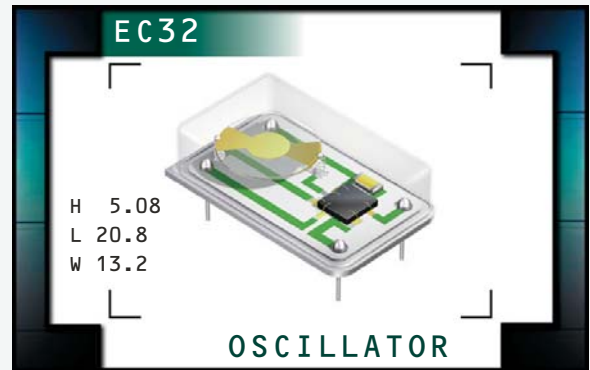

ECLIPTEK[®]
CORPORATION

- RoHS Compliant (Pb-free)
- Voltage Controlled Crystal Oscillator (VCXO)
- 3.3V Supply Voltage
- HCMOS/TTL output
- 14 pin DIP package
- Stability to ± 20 ppm
- Wide frequency and pull range



NOTES

ELECTRICAL SPECIFICATIONS

Frequency Range (MHz)	1.000MHz to 44.736MHz	
Operating Temperature Range	0°C to 70°C or -40°C to +85°C	
Storage Temperature Range	-55°C to +125°C	
Supply Voltage (V_{DD})	3.3V _{DC} $\pm 10\%$	
Aging (at 25°C)	± 5 ppm / year Maximum	
Load Drive Capability	2TTL Load or 15pF HCMOS Load Maximum	
Start Up Time	10 mSeconds Maximum	
Frequency Deviation / Control Voltage	1.65V _{DC} ± 1.65 V _{DC} Positive Transfer Characteristic, or	± 50 ppm Minimum
	1.65V _{DC} ± 1.65 V _{DC} Positive Transfer Characteristic	± 100 ppm Minimum
Linearity	$\pm 20\%$ Maximum, $\pm 15\%$ Maximum, or 10% Maximum	
Input Current	1.000MHz to 20.000MHz	10mA Maximum
	20.001MHz to 44.736MHz	20mA Maximum
Frequency Tolerance / Stability	Inclusive of Operating Temperature Range, Supply Voltage, and Load	± 100 ppm, ± 50 ppm, ± 25 ppm, or ± 20 ppm Maximum (0°C to 70°C Only)
Output Voltage Logic High (V_{OH})	w/TTL Load	2.4V _{DC} Minimum
	w/HCMOS Load	2.7V _{DC} Minimum
Output Voltage Logic Low (V_{OL})	w/TTL Load or w/HCMOS Load	0.4V _{DC} Maximum
Duty Cycle	at 50% of Waveform	50 ± 10 (%) (Standard)
	at 50% of Waveform	50 ± 5 (%) (Optional)
Rise Time / Fall Time	0.4V _{DC} to 2.4V _{DC} w/TTL Load; 20% to 80% of Waveform w/HCMOS Load	5 nSeconds Maximum
Period Jitter: Absolute	± 100 pSeconds Maximum	
Period Jitter: One Sigma	± 25 pSeconds Maximum	

MANUFACTURER
ECLIPTEK CORP.

CATEGORY
OSCILLATOR

SERIES
EC32

PACKAGE
14 pin DIP

VOLTAGE
3.3V

CLASS
0546

REV. DATE
08/06

PART NUMBERING GUIDE

EC32 00 T A 15 ET - 24.000M - G

FREQUENCY TOLERANCE / STABILITY

00=±100ppm Maximum (Standard)
 45=±50ppm Maximum, 25=±25ppm Maximum
 20=±20ppm Maximum

DUTY CYCLE

Blank=50 ±10% (Standard), T=50 ±5%

FREQUENCY DEVIATION

Blank=±50ppm Minimum (Standard)
 A=±100ppm Minimum

AVAILABLE OPTIONS

Blank=None (Standard)
 CLXXX=Custom Lead Length (See Page 133)
 G=Full Size Gull Wing (See Page 132)

FREQUENCY

OPERATING TEMP. RANGE

Blank=0°C to 70°C (Standard)
 ET=-40°C to 85°C

LINEARITY

Blank=20% Maximum (Standard)
 15=15% Maximum
 10=10% Maximum

NOTES

MECHANICAL DIMENSIONS ALL DIMENSIONS IN MILLIMETERS

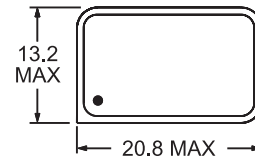
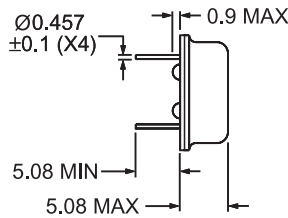
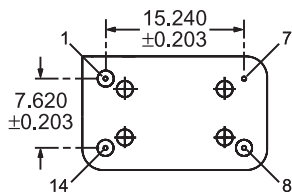

Pin 1: Control Voltage (V_c)
 Pin 7: Case Ground

Pin 8: Output
 Pin 14: Supply Voltage

ENVIRONMENTAL/MECHANICAL SPECIFICATIONS

Characteristic	Specification
Seal Integrity	Bubble test in Perfluorocarbon at +125°C ±5°C for 60 seconds minimum.
Solderability	Sn63 Solder dip at +230°C ±5°C for 5 seconds/95% coverage.
Marking Permanency	10 Strokes with brush after 1 minute soak in solvent, 3 times.
Shock	Random drop on hard wooden plate 3 times from a height of 20cm.
Vibration	Frequency with an amplitude of 1.5mm sweeping between 10Hz to 55Hz within 1 minute (approximately) for 2 hours minimum on each axis (X, Y and Z) for a total of 6 hours.

MARKING SPECIFICATIONS

Line 1: ECLIPTEK
 Line 2: EC32
 ————— Series Designator
 Line 3: XX.XXX M.
 ————— Frequency in MHz
 (5 Digits Maximum + Decimal)
 Line 4: XX Y ZZ
 ————— Week of Year
 ————— Last Digit of Year
 ————— Ecliptek Manufacturing Identifier

Note: Pin 1 shall be designated with a dot

MANUFACTURER	CATEGORY	SERIES	PACKAGE	VOLTAGE	CLASS	REV. DATE
ECLIPTEK CORP.	OSCILLATOR	EC32	14 pin DIP	3.3V	OS46	08/06

EC32 Series



ECLIPTEK[®]
CORPORATION

- RoHS Compliant (Pb-free)
- Voltage Controlled Crystal Oscillator (VCX0)
- 3.3V Supply Voltage
- HCMOS/TTL output
- 8 pin DIP package
- Stability to ± 20 ppm
- Wide frequency and pull range

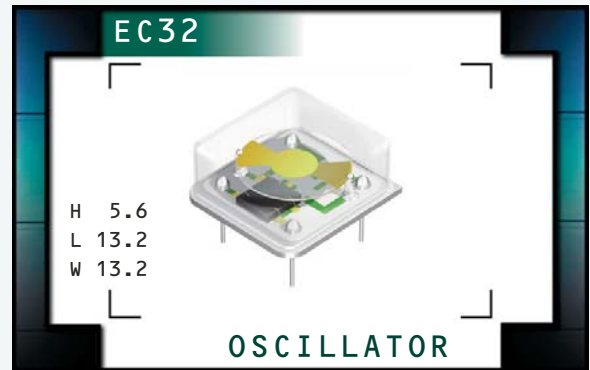

NOTES

ELECTRICAL SPECIFICATIONS

Frequency Range (MHz)	1.000MHz to 44.736MHz	
Operating Temperature Range	0°C to 70°C or -40°C to +85°C	
Storage Temperature Range	-55°C to +125°C	
Supply Voltage (V_{DD})	3.3V _{DC} $\pm 10\%$	
Aging (at 25°C)	± 5 ppm / year Maximum	
Load Drive Capability	2TTL Load or 15pF HCMOS Load Maximum	
Start Up Time	10 mSeconds Maximum	
Frequency Deviation / Control Voltage	1.65V _{DC} ± 1.65 V _{DC} Positive Transfer Characteristic, or	± 50 ppm Minimum
	1.65V _{DC} ± 1.65 V _{DC} Positive Transfer Characteristic	± 100 ppm Minimum
Linearity	$\pm 20\%$ Maximum, $\pm 15\%$ Maximum, or 10% Maximum	
Input Current	1.000MHz to 20.000MHz	10mA Maximum
	20.001MHz to 44.736MHz	20mA Maximum
Frequency Tolerance / Stability	Inclusive of Operating Temperature Range, Supply Voltage, and Load	± 100 ppm, ± 50 ppm, ± 25 ppm, or ± 20 ppm Maximum (0°C to 70°C Only)
Output Voltage Logic High (V_{OH})	w/TTL Load	2.4V _{DC} Minimum
	w/HCMOS Load	2.7V _{DC} Minimum
Output Voltage Logic Low (V_{OL})	w/TTL Load or w/HCMOS Load	0.4V _{DC} Maximum
Duty Cycle	at 50% of Waveform	50 ± 10 (%) (Standard)
	at 50% of Waveform	50 ± 5 (%) (Optional)
Rise Time / Fall Time	0.4V _{DC} to 2.4V _{DC} w/TTL Load; 20% to 80% of Waveform w/HCMOS Load	5 nSeconds Maximum
Period Jitter: Absolute	± 100 pSeconds Maximum	
Period Jitter: One Sigma	± 25 pSeconds Maximum	

MANUFACTURER
ECLIPTEK CORP.

CATEGORY
OSCILLATOR

SERIES
EC32

PACKAGE
8 pin DIP

VOLTAGE
3.3V

CLASS
0547

REV. DATE
08/06

PART NUMBERING GUIDE

EC32 00 HST A 15 ET - 24.000M - G TR

FREQUENCY TOLERANCE / STABILITY

00=±100ppm Maximum (Standard)
 45=±50ppm Maximum, 25=±25ppm Maximum
 20=±20ppm Maximum

PACKAGE

HS=Half Size 8 Pin DIP

DUTY CYCLE

Blank=50±10(%) (Standard), T=50±5(%)

FREQUENCY DEVIATION

Blank=±50ppm Minimum (Standard)
 A=±100ppm Minimum

PACKAGING OPTIONS

Blank=Bulk (Standard)
 TR=Tape & Reel (only offered with
 Half Size G and Half Size G2 Options)

AVAILABLE OPTIONS

Blank=None (Standard)
 CLXX=Custom Lead Length (See Page 133)
 G=Half Size Gull Wing (See Page 132)
 G2=Alternate Half Size Gull Wing (See Page 132)

FREQUENCY

OPERATING TEMP. RANGE
 Blank=0°C to 70°C (Standard)
 ET=-40°C to 85°C

LINEARITY

Blank=20% Maximum (Standard)
 15=15% Maximum, 10=10% Maximum

MECHANICAL DIMENSIONS

ALL DIMENSIONS IN MILLIMETERS

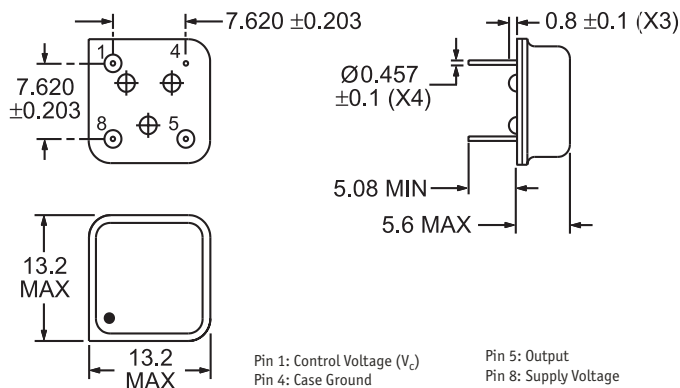

TAPE AND REEL DIMENSIONS

ALL DIMENSIONS IN MILLIMETERS

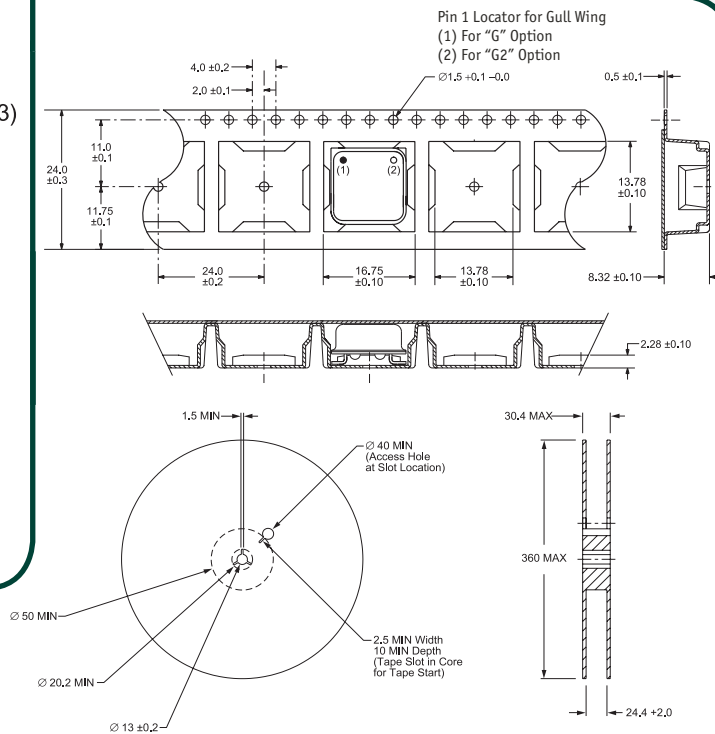

MARKING SPECIFICATIONS

Line 1: ECLIPTEK

Line 2: EC32

Series Designator

Line 3: XX.XXX M

Frequency in MHz
 (5 Digits Maximum + Decimal)

Line 4: XX Y ZZ

Week of Year
 Last Digit of Year
 Ecliptek Manufacturing Identifier

ENVIRONMENTAL/MECHANICAL SPECIFICATIONS

Characteristic	Specification
Seal Integrity	Bubble test in Perfluorocarbon at +125°C ±5°C for 60 seconds minimum.
Solderability	Sn63 Solder dip at +230°C ±5°C for 5 seconds/95% coverage.
Marking Permanency	10 Strokes with brush after 1 minute soak in solvent, 3 times.
Shock	Random drop on hard wooden plate 3 times from a height of 20cm.
Vibration	Frequency with an amplitude of 1.5mm sweeping between 10Hz to 55Hz within 1 minute (approximately) for 2 hours minimum on each axis (X, Y and Z) for a total of 6 hours.

MANUFACTURER	CATEGORY	SERIES	PACKAGE	VOLTAGE	CLASS	REV. DATE
ECLIPTEK CORP.	OSCILLATOR	EC32	8 pin DIP	3.3V	OS47	08/06