

**16 M-WORD BY 72-BIT SYNCHRONOUS DYNAMIC RAM MODULE
REGISTERED TYPE****Description**

The MC-4516DA726 is a 16,777,216 words by 72 bits synchronous dynamic RAM module on which 9 pieces of 128M SDRAM: μ PD45128841 are assembled.

These modules provide high density and large quantities of memory in a small space without utilizing the surface-mounting technology on the printed circuit board.

Decoupling capacitors are mounted on power supply line for noise reduction.

Features

- 16,777,216 words by 72 bits organization (ECC type)
- Clock frequency and access time from CLK

| Part number | /CAS latency | Clock frequency (MAX.) | Access time from CLK (MAX.) | Module type |
|---------------------|--------------|---------------------------|--------------------------------|---|
| MC-4516DA726EFC-A80 | CL = 3 | 125 MHz | 6 ns | PC100 Registered DIMM Rev. 1.2 Compliant |
| | CL = 2 | 100 MHz | 6 ns | |
| MC-4516DA726EFC-A10 | CL = 3 | 100 MHz | 6 ns | |
| | CL = 2 | 77 MHz | 7 ns | |
| MC-4516DA726PFC-A80 | CL = 3 | 125 MHz | 6 ns | |
| | CL = 2 | 100 MHz | 6 ns | |
| MC-4516DA726PFC-A10 | CL = 3 | 100 MHz | 6 ns | |
| | CL = 2 | 77 MHz | 7 ns | |
| MC-4516DA726XFC-A80 | CL = 3 | 125 MHz | 6 ns | |
| | CL = 2 | 100 MHz | 6 ns | |
| MC-4516DA726XFC-A10 | CL = 3 | 100 MHz | 6 ns | |
| | CL = 2 | 77 MHz | 7 ns | |

- Fully Synchronous Dynamic RAM, with all signals referenced to a positive clock edge
- Pulsed interface
- Possible to assert random column address in every cycle
- Quad internal banks controlled by BA0 and BA1 (Bank Select)
- Programmable burst-length (1, 2, 4, 8 and Full Page)
- Programmable wrap sequence (Sequential / Interleave)
- Programmable /CAS latency (2, 3)

The information in this document is subject to change without notice. Before using this document, please confirm that this is the latest version.
Not all devices/types available in every country. Please check with local Elpida Memory, Inc. for availability and additional information.

- Automatic precharge and controlled precharge
- CBR (Auto) refresh and self refresh
- All DQs have $10\ \Omega \pm 10\%$ of series resistor
- Single $3.3\ V \pm 0.3\ V$ power supply
- LVTTTL compatible
- 4,096 refresh cycles / 64 ms
- Burst termination by Burst Stop command and Precharge command
- 168-pin dual in-line memory module (Pin pitch = 1.27 mm)
- Registered type
- Serial PD

Ordering Information

| Part number | Clock frequency (MAX.) | Package | Mounted devices |
|---------------------|------------------------|--|---|
| MC-4516DA726EFC-A80 | 125 MHz | 168-pin Dual In-line Memory Module (Socket Type) Edge connector: Gold plated 38.1 mm height | 9 pieces of μ PD45128841G5 (Rev. E) (10.16 mm (400) TSOP (II)) |
| MC-4516DA726EFC-A10 | 100 MHz | | 9 pieces of μ PD45128841G5 (Rev. P) (10.16 mm (400) TSOP (II)) |
| MC-4516DA726PFC-A80 | 125 MHz | | 9 pieces of μ PD45128841G5 (Rev. X) (10.16 mm (400) TSOP (II)) |
| MC-4516DA726PFC-A10 | 100 MHz | | |
| MC-4516DA726XFC-A80 | 125 MHz | | |
| MC-4516DA726XFC-A10 | 100 MHz | | |

Pin Configuration

168-pin Dual In-line Memory Module Socket Type (Edge connector: Gold plated)

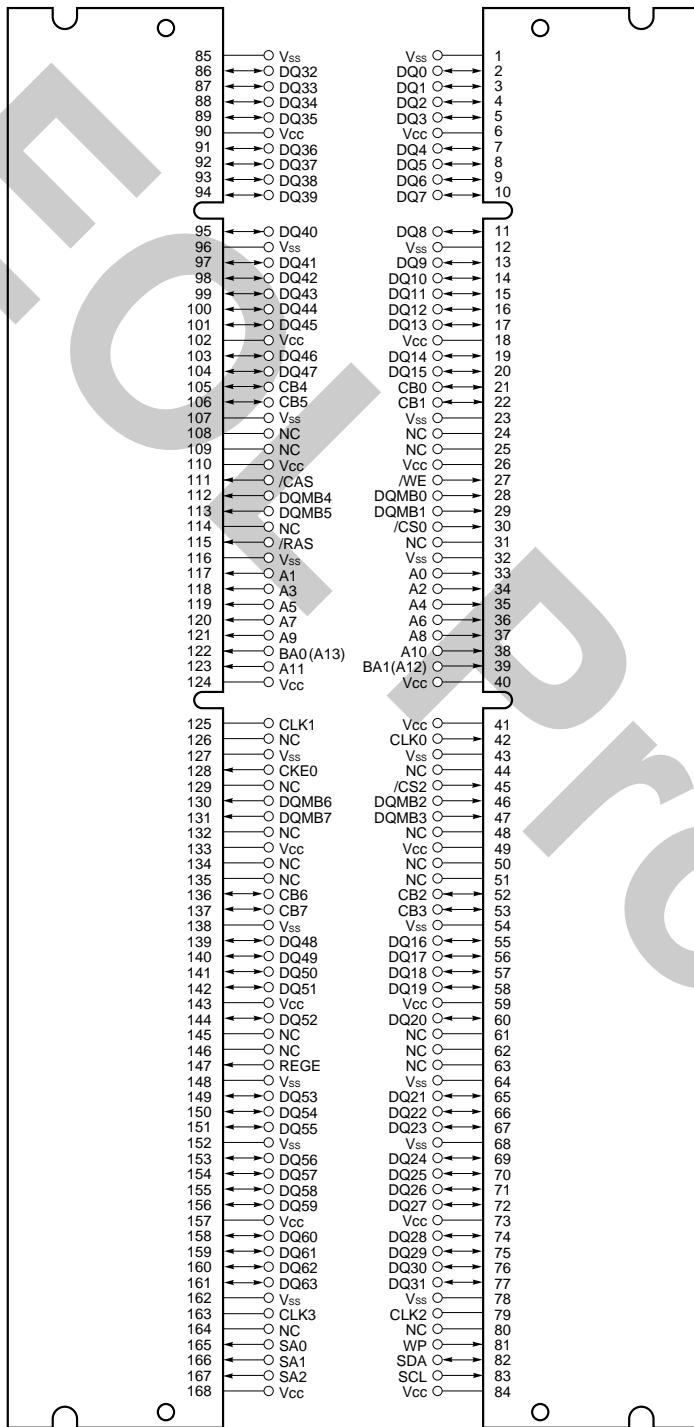

/xxx indicates active low signal.

- A0 - A11 : Address Inputs
[Row: A0 - A11, Column: A0 - A9]
- BA0 (A13), BA1 (A12) : SDRAM Bank Select
- DQ0 - DQ63, CB0 - CB7: Data Inputs/Outputs
- CLK0 - CLK3 : Clock Input
- CKE0 : Clock Enable Input
- WP : Write Protect
- /CS0, /CS2 : Chip Select Input
- /RAS : Row Address Strobe
- /CAS : Column Address Strobe
- /WE : Write Enable
- DQMB0 - DQMB7 : DQ Mask Enable
- SA0 - SA2 : Address Input for EEPROM
- SDA : Serial Data I/O for PD
- SCL : Clock Input for PD
- Vcc : Power Supply
- Vss : Ground
- REGE : Register / Buffer Enable
- NC : No Connection

Block Diagram

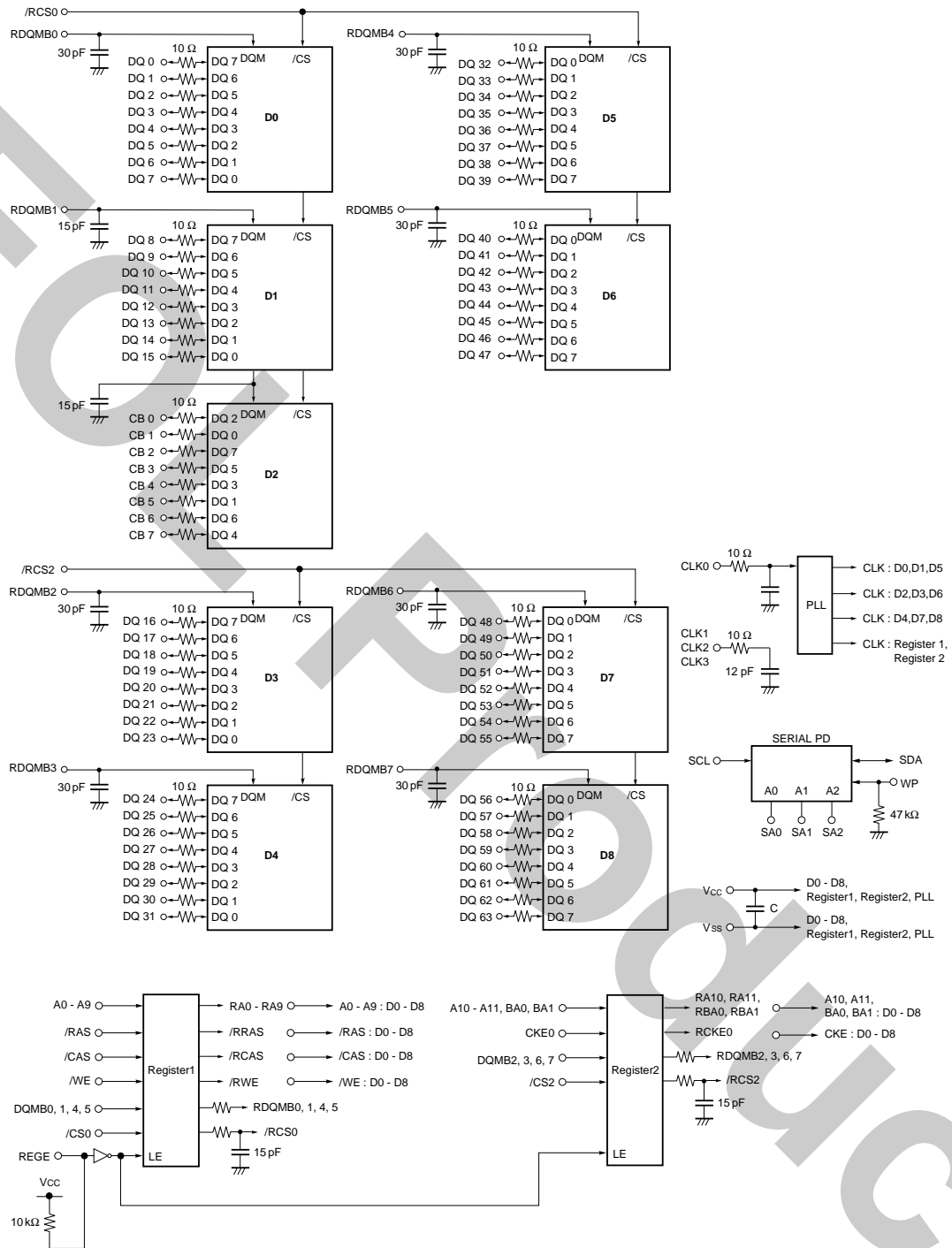

- Remarks**
1. The value of all resistors of DQs is 10 Ω.
 2. D0 - D18: μ PD45128841 (4M words \times 8 bits \times 4 banks)
 3. REGE \leq V_{IL}: Buffer mode
REGE \geq V_{IH}: Register mode
 4. Register: HD74ALVC162835
PLL: HD74CDC2509B

Electrical Specifications

- All voltages are referenced to V_{SS} (GND).
- After power up, wait more than 1 ms and then, execute power on sequence and CBR (Auto) refresh before proper device operation is achieved.

Absolute Maximum Ratings

| Parameter | Symbol | Condition | Rating | Unit |
|---|-----------|-----------|--------------|------|
| Voltage on power supply pin relative to GND | V_{CC} | | -0.5 to +4.6 | V |
| Voltage on input pin relative to GND | V_T | | -0.5 to +4.6 | V |
| Short circuit output current | I_O | | 50 | mA |
| Power dissipation | P_D | | 12 | W |
| Operating ambient temperature | T_A | | 0 to 70 | °C |
| Storage temperature | T_{stg} | | -55 to +125 | °C |

Caution Exposing the device to stress above those listed in Absolute Maximum Ratings could cause permanent damage. The device is not meant to be operated under conditions outside the limits described in the operational section of this specification. Exposure to Absolute Maximum Rating conditions for extended periods may affect device reliability.

Recommended Operating Conditions

| Parameter | Symbol | Condition | MIN. | TYP. | MAX. | Unit |
|-------------------------------|----------|-----------|------|------|----------------|------|
| Supply voltage | V_{CC} | | 3.0 | 3.3 | 3.6 | V |
| High level input voltage | V_{IH} | | 2.0 | | $V_{CC} + 0.3$ | V |
| Low level input voltage | V_{IL} | | -0.3 | | +0.8 | V |
| Operating ambient temperature | T_A | | 0 | | 70 | °C |

Capacitance ($T_A = 25\text{ °C}$, $f = 1\text{ MHz}$)

| Parameter | Symbol | Test condition | MIN. | TYP. | MAX. | Unit |
|-------------------------------|-----------|---|------|------|------|------|
| Input capacitance | C_{I1} | A0 – A11, BA0 (A13), BA1 (A12), /RAS, /CAS, /WE | 4 | | 10 | pF |
| | C_{I2} | CLK0 | 15 | | 25 | |
| | C_{I3} | CKE0 | 4 | | 10 | |
| | C_{I4} | /CS0, /CS2 | 4 | | 10 | |
| | C_{I5} | DQMB0 - DQMB7 | 3 | | 10 | |
| Data input/output capacitance | $C_{I/O}$ | DQ0 - DQ63, CB0 - CB7 | 5 | | 13 | pF |

DC Characteristics (Recommended Operating Conditions unless otherwise noted)

| Parameter | Symbol | Test condition | | Grade | MIN. | MAX. | Unit | Notes |
|--|--------------------|--|------------------|-------|------|-------|------|-------|
| Operating current | I _{CC1} | Burst length = 1 t _{RC} ≥ t _{RC (MIN.)} , I _O = 0 mA | /CAS latency = 2 | -A80 | | 1,200 | mA | 1 |
| | | | | -A10 | | 1,200 | | |
| | | | /CAS latency = 3 | -A80 | | 1,200 | | |
| | | | | -A10 | | 1,200 | | |
| Precharge standby current in power down mode | I _{CC2P} | CKE ≤ V _{IL (MAX.)} , t _{CK} = 15 ns | | | | 259 | mA | |
| | I _{CC2PS} | CKE ≤ V _{IL (MAX.)} , t _{CK} = ∞ | | | | 89 | | |
| Precharge standby current in non power down mode | I _{CC2N} | CKE ≥ V _{IH (MIN.)} , t _{CK} = 15 ns, /CS ≥ V _{IH (MIN.)} , Input signals are changed one time during 30 ns. | | | | 430 | mA | |
| | I _{CC2NS} | CKE ≥ V _{IH (MIN.)} , t _{CK} = ∞, Input signals are stable. | | | | 152 | | |
| Active standby current in power down mode | I _{CC3P} | CKE ≤ V _{IL (MAX.)} , t _{CK} = 15 ns | | | | 295 | mA | |
| | I _{CC3PS} | CKE ≤ V _{IL (MAX.)} , t _{CK} = ∞ | | | | 116 | | |
| Active standby current in non power down mode | I _{CC3N} | CKE ≥ V _{IH (MIN.)} , t _{CK} = 15 ns, /CS ≥ V _{IH (MIN.)} , Input signals are changed one time during 30 ns. | | | | 520 | mA | |
| | I _{CC3NS} | CKE ≥ V _{IH (MIN.)} , t _{CK} = ∞, Input signals are stable. | | | | 260 | | |
| Operating current (Burst mode) | I _{CC4} | t _{CK} ≥ t _{CK (MIN.)} , I _O = 0 mA | /CAS latency = 2 | -A80 | | 1,380 | mA | 2 |
| | | | | -A10 | | 1,155 | | |
| | | | /CAS latency = 3 | -A80 | | 1,605 | | |
| | | | | -A10 | | 1,425 | | |
| CBR (Auto) Refresh current | I _{CC5} | t _{RC} ≥ t _{RC (MIN.)} | /CAS latency = 2 | -A80 | | 2,370 | mA | 3 |
| | | | | -A10 | | 2,370 | | |
| | | | /CAS latency = 3 | -A80 | | 2,370 | | |
| | | | | -A10 | | 2,370 | | |
| Self refresh current | I _{CC6} | CKE ≤ 0.2 V | | | | 268 | mA | |
| Input leakage current | I _{I (L)} | V _I = 0 to 3.6 V, All other pins not under test = 0 V | | | -10 | +10 | μA | |
| Output leakage current | I _{O (L)} | D _{OUT} is disabled, V _O = 0 to 3.6 V | | | -1.5 | +1.5 | μA | |
| High level output voltage | V _{OH} | I _O = -4.0 mA | | | 2.4 | | V | |
| Low level output voltage | V _{OL} | I _O = +4.0 mA | | | | 0.4 | V | |

- Notes**
- I_{CC1} depends on output loading and cycle rates. Specified values are obtained with the output open.
In addition to this, I_{CC1} is measured on condition that addresses are changed only one time during t_{CK (MIN.)}.
 - I_{CC4} depends on output loading and cycle rates. Specified values are obtained with the output open.
In addition to this, I_{CC4} is measured on condition that addresses are changed only one time during t_{CK (MIN.)}.
 - I_{CC5} is measured on condition that addresses are changed only one time during t_{CK (MIN.)}.

AC Characteristics (Recommended Operating Conditions Unless Otherwise Noted)

Test Conditions

| Parameter | Value | Unit |
|---|-----------|------|
| AC high level input voltage / low level input voltage | 2.4 / 0.4 | V |
| Input timing measurement reference level | 1.4 | V |
| Transition time (Input rise and fall time) | 1 | ns |
| Output timing measurement reference level | 1.4 | V |

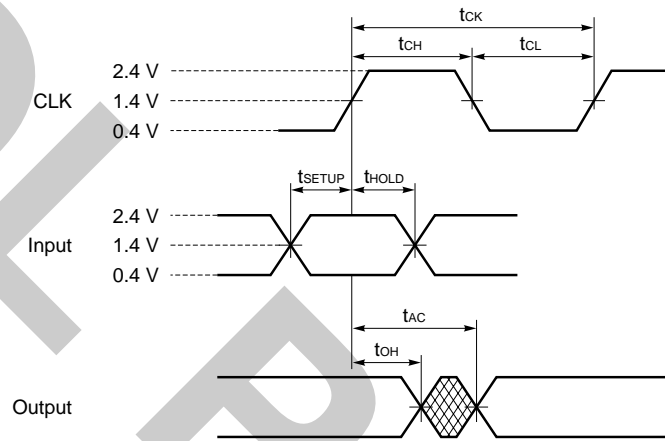

Synchronous Characteristics

| Parameter | | Symbol | -A80 | | -A10 | | Unit | Note |
|---|------------------|-------------------|------|-----------|------|-----------|------|------|
| | | | MIN. | MAX. | MIN. | MAX. | | |
| Clock cycle time | /CAS latency = 3 | t _{CK3} | 8 | (125 MHz) | 10 | (100 MHz) | ns | |
| | /CAS latency = 2 | t _{CK2} | 10 | (100 MHz) | 13 | (77 MHz) | ns | |
| Access time from CLK | /CAS latency = 3 | t _{AC3} | | 6 | | 6 | ns | 1 |
| | /CAS latency = 2 | t _{AC2} | | 6 | | 7 | ns | 1 |
| Input clock frequency | | | 50 | 125 | 50 | 100 | MHz | |
| Input CLK duty cycle | | | 40 | 60 | 40 | 60 | % | |
| Data-out hold time | /CAS latency = 3 | t _{OH3} | 3 | | 3 | | ns | 1 |
| | /CAS latency = 2 | t _{OH2} | 3 | | 3 | | ns | 1 |
| Data-out low-impedance time | | t _{LZ} | 0 | | 0 | | ns | |
| Data-out high- impedance time | /CAS latency = 3 | t _{HZ3} | 3 | 6 | 3 | 6 | ns | |
| | /CAS latency = 2 | t _{HZ2} | 3 | 6 | 3 | 7 | ns | |
| Data-in setup time | | t _{DS} | 2 | | 2 | | ns | |
| Data-in hold time | | t _{DH} | 1 | | 1 | | ns | |
| Address setup time | | t _{AS} | 2 | | 2 | | ns | |
| Address hold time | | t _{AH} | 1 | | 1 | | ns | |
| CKE setup time | | t _{CKS} | 2 | | 2 | | ns | |
| CKE hold time | | t _{CKH} | 1 | | 1 | | ns | |
| CKE setup time (Power down exit) | | t _{CKSP} | 2 | | 2 | | ns | |
| Command (/CS0, /CS2, /RAS, /CAS, /WE, DQMB0 - DQMB7) setup time | | t _{CMS} | 2 | | 2 | | ns | |
| Command (/CS0, /CS2, /RAS, /CAS, /WE, DQMB0 - DQMB7) hold time | | t _{CMH} | 1 | | 1 | | ns | |

Note 1. Output load

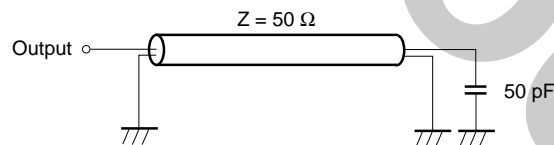

Remark These specifications are applied to the monolithic device.

Asynchronous Characteristics

| Parameter | Symbol | -A 80 | | -A 10 | | Unit | Note |
|---|------------------|-------------------|---------|----------|---------|------|------|
| | | MIN. | MAX. | MIN. | MAX. | | |
| REF to REF/ACT command period | t _{RC} | 70 | | 70 | | ns | |
| ACT to PRE command period | t _{RAS} | 48 | 120,000 | 50 | 120,000 | ns | |
| PRE to ACT command period | t _{RP} | 20 | | 20 | | ns | |
| Delay time ACT to READ/WRITE command | t _{RCD} | 20 | | 20 | | ns | |
| ACT(one) to ACT(another) command period | t _{RRD} | 16 | | 20 | | ns | |
| Data-in to PRE command period | t _{DPL} | -1CLK+8 | | -1CLK+10 | | ns | |
| Data-in to ACT(REF) command period (Auto precharge) | /CAS latency = 3 | t _{DAL3} | 20 | 20 | | ns | |
| | /CAS latency = 2 | t _{DAL2} | 20 | 20 | | ns | |
| Mode register set cycle time | t _{RSC} | 2 | | 2 | | CLK | |
| Transition time | t _T | 0.5 | 30 | 1 | 30 | ns | |
| Refresh time (4,096 refresh cycles) | t _{REF} | | 64 | | 64 | ms | |

Serial PD

(1/2)

| Byte No. | Function Described | Hex | Bit 7 | Bit 6 | Bit 5 | Bit 4 | Bit 3 | Bit 2 | Bit 1 | Bit 0 | Notes | |
|----------|---|------|-------|-------|-------|-------|-------|-------|-------|-------|---------------|-------|
| 0 | Defines the number of bytes written into serial PD memory | 80H | 1 | 0 | 0 | 0 | 0 | 0 | 0 | 0 | 128 bytes | |
| 1 | Total number of bytes of serial PD memory | 08H | 0 | 0 | 0 | 0 | 1 | 0 | 0 | 0 | 256 bytes | |
| 2 | Fundamental memory type | 04H | 0 | 0 | 0 | 0 | 0 | 1 | 0 | 0 | SDRAM | |
| 3 | Number of rows | 0CH | 0 | 0 | 0 | 0 | 1 | 1 | 0 | 0 | 12 rows | |
| 4 | Number of columns | 0AH | 0 | 0 | 0 | 0 | 1 | 0 | 1 | 0 | 10 columns | |
| 5 | Number of banks | 01H | 0 | 0 | 0 | 0 | 0 | 0 | 0 | 1 | 1 bank | |
| 6 | Data width | 48H | 0 | 1 | 0 | 0 | 1 | 0 | 0 | 0 | 72 bits | |
| 7 | Data width (continued) | 00H | 0 | 0 | 0 | 0 | 0 | 0 | 0 | 0 | 0 | |
| 8 | Voltage interface | 01H | 0 | 0 | 0 | 0 | 0 | 0 | 0 | 1 | LVTTTL | |
| 9 | CL = 3 Cycle time | -A80 | 80H | 1 | 0 | 0 | 0 | 0 | 0 | 0 | 0 | 8 ns |
| | | -A10 | A0H | 1 | 0 | 1 | 0 | 0 | 0 | 0 | 0 | 10 ns |
| 10 | CL = 3 Access time | -A80 | 60H | 0 | 1 | 1 | 0 | 0 | 0 | 0 | 0 | 6 ns |
| | | -A10 | 60H | 0 | 1 | 1 | 0 | 0 | 0 | 0 | 0 | 6 ns |
| 11 | DIMM configuration type | 02H | 0 | 0 | 0 | 0 | 0 | 0 | 1 | 0 | ECC | |
| 12 | Refresh rate/type | 80H | 1 | 0 | 0 | 0 | 0 | 0 | 0 | 0 | Normal | |
| 13 | SDRAM width | 08H | 0 | 0 | 0 | 0 | 1 | 0 | 0 | 0 | x8 | |
| 14 | Error checking SDRAM width | 08H | 0 | 0 | 0 | 0 | 1 | 0 | 0 | 0 | x8 | |
| 15 | Minimum clock delay | 01H | 0 | 0 | 0 | 0 | 0 | 0 | 0 | 1 | 1 clock | |
| 16 | Burst length supported | 8FH | 1 | 0 | 0 | 0 | 1 | 1 | 1 | 1 | 1, 2, 4, 8, F | |
| 17 | Number of banks on each SDRAM | 04H | 0 | 0 | 0 | 0 | 0 | 1 | 0 | 0 | 4 banks | |
| 18 | /CAS latency supported | 06H | 0 | 0 | 0 | 0 | 0 | 1 | 1 | 0 | 2, 3 | |
| 19 | /CS latency supported | 01H | 0 | 0 | 0 | 0 | 0 | 0 | 0 | 1 | 0 | |
| 20 | /WE latency supported | 01H | 0 | 0 | 0 | 0 | 0 | 0 | 0 | 1 | 0 | |
| 21 | SDRAM module attributes | 1FH | 0 | 0 | 0 | 1 | 1 | 1 | 1 | 1 | Registered | |
| 22 | SDRAM device attributes : General | 0EH | 0 | 0 | 0 | 0 | 1 | 1 | 1 | 0 | | |
| 23 | CL = 2 Cycle time | -A80 | A0H | 1 | 0 | 1 | 0 | 0 | 0 | 0 | 0 | 10 ns |
| | | -A10 | D0H | 1 | 1 | 0 | 1 | 0 | 0 | 0 | 0 | 13 ns |
| 24 | CL = 2 Access time | -A80 | 60H | 0 | 1 | 1 | 0 | 0 | 0 | 0 | 0 | 6 ns |
| | | -A10 | 70H | 0 | 1 | 1 | 1 | 0 | 0 | 0 | 0 | 7 ns |
| 25-26 | | 00H | 0 | 0 | 0 | 0 | 0 | 0 | 0 | 0 | | |
| 27 | t _{RP} (MIN.) | -A80 | 14H | 0 | 0 | 0 | 1 | 0 | 1 | 0 | 0 | 20 ns |
| | | -A10 | 14H | 0 | 0 | 0 | 1 | 0 | 1 | 0 | 0 | 20 ns |
| 28 | t _{RRD} (MIN.) | -A80 | 10H | 0 | 0 | 0 | 1 | 0 | 0 | 0 | 0 | 16 ns |
| | | -A10 | 14H | 0 | 0 | 0 | 1 | 0 | 1 | 0 | 0 | 20 ns |
| 29 | t _{RCD} (MIN.) | -A80 | 14H | 0 | 0 | 0 | 1 | 0 | 1 | 0 | 0 | 20 ns |
| | | -A10 | 14H | 0 | 0 | 0 | 1 | 0 | 1 | 0 | 0 | 20 ns |
| 30 | t _{RAS} (MIN.) | -A80 | 30H | 0 | 0 | 1 | 1 | 0 | 0 | 0 | 0 | 48 ns |
| | | -A10 | 32H | 0 | 0 | 1 | 1 | 0 | 0 | 1 | 0 | 50 ns |
| 31 | Module bank density | 20H | 0 | 0 | 1 | 0 | 0 | 0 | 0 | 0 | 128M bytes | |

(2/2)

| Byte No. | Function Described | Hex | Bit 7 | Bit 6 | Bit 5 | Bit 4 | Bit 3 | Bit 2 | Bit 1 | Bit 0 | Notes | |
|----------|---|------|-------|-------|-------|-------|-------|-------|-------|-------|---------|--|
| 32 | Command and address signal input setup time | 20H | 0 | 0 | 1 | 0 | 0 | 0 | 0 | 0 | 2 ns | |
| 33 | Command and address signal input hold time | 10H | 0 | 0 | 0 | 1 | 0 | 0 | 0 | 0 | 1 ns | |
| 34 | Data signal input setup time | 20H | 0 | 0 | 1 | 0 | 0 | 0 | 0 | 0 | 2 ns | |
| 35 | Data signal input hold time | 10H | 0 | 0 | 0 | 1 | 0 | 0 | 0 | 0 | 1 ns | |
| 36-61 | | 00H | 0 | 0 | 0 | 0 | 0 | 0 | 0 | 0 | | |
| 62 | SPD revision | 12H | 0 | 0 | 0 | 1 | 0 | 0 | 1 | 0 | 1.2 A | |
| 63 | Checksum for bytes 0 - 62 | -A80 | 21H | 0 | 0 | 1 | 0 | 0 | 0 | 0 | 1 | |
| | | -A10 | 87H | 1 | 0 | 0 | 0 | 0 | 1 | 1 | 1 | |
| 64-71 | Manufacture's JEDEC ID code | | | | | | | | | | | |
| 72 | Manufacturing location | | | | | | | | | | | |
| 73-90 | Manufacture's P/N | | | | | | | | | | | |
| 91 | Revision Code | | | | | | | | | | | |
| 93-94 | Manufacturing date | | | | | | | | | | | |
| 95-98 | Assembly serial number | | | | | | | | | | | |
| 99-125 | Mfg specific | | | | | | | | | | | |
| 126 | Intel specification frequency | 64H | 0 | 1 | 1 | 0 | 0 | 1 | 0 | 0 | 100 MHz | |
| 127 | Intel specification /CAS latency support | -A80 | 87H | 1 | 0 | 0 | 0 | 0 | 1 | 1 | 1 | |
| | | -A10 | 85H | 1 | 0 | 0 | 0 | 0 | 1 | 0 | 1 | |

Timing Chart

Refer to the μ PD45128441, 45128841, 45128163 Data sheet (E0031N).

Package Drawing

168-PIN DUAL IN-LINE MODULE (SOCKET TYPE)

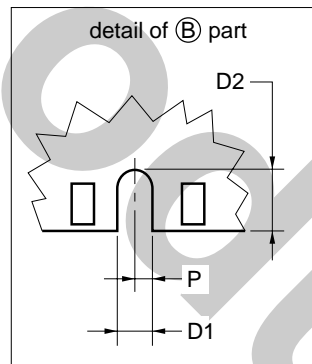
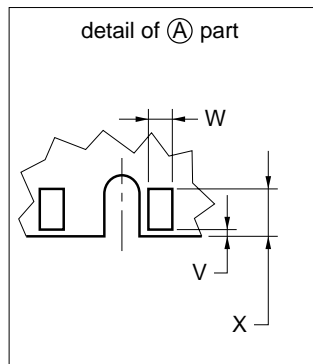
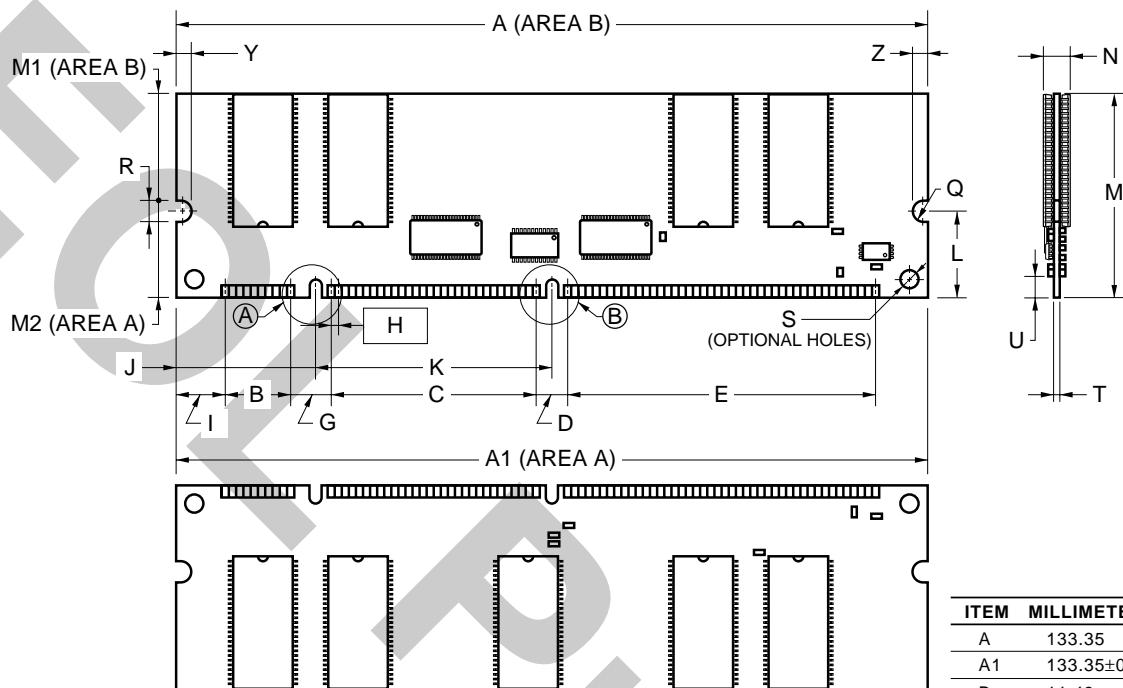

| ITEM | MILLIMETERS |
|------|-------------|
| A | 133.35 |
| A1 | 133.35±0.13 |
| B | 11.43 |
| C | 36.83 |
| D | 6.35 |
| D1 | 2.0 |
| D2 | 3.125 |
| E | 54.61 |
| G | 6.35 |
| H | 1.27 (T.P.) |
| I | 8.89 |
| J | 24.495 |
| K | 42.18 |
| L | 17.78 |
| M | 38.1±0.13 |
| M1 | 18.32 |
| M2 | 19.78 |
| N | 4.0 MAX. |
| P | 1.0 |
| Q | R2.0 |
| R | 4.0±0.10 |
| S | ∅ 3.0 |
| T | 1.27±0.1 |
| U | 4.0 MIN. |
| V | 0.2±0.15 |
| W | 1.0±0.05 |
| X | 2.54±0.10 |
| Y | 3.0 MIN. |
| Z | 3.0 MIN. |

M168S-50A106

[MEMO]

FOR Product

[MEMO]

FOR Product

NOTES FOR CMOS DEVICES

① PRECAUTION AGAINST ESD FOR SEMICONDUCTORS

Note:

Strong electric field, when exposed to a MOS device, can cause destruction of the gate oxide and ultimately degrade the device operation. Steps must be taken to stop generation of static electricity as much as possible, and quickly dissipate it once, when it has occurred. Environmental control must be adequate. When it is dry, humidifier should be used. It is recommended to avoid using insulators that easily build static electricity. Semiconductor devices must be stored and transported in an anti-static container, static shielding bag or conductive material. All test and measurement tools including work bench and floor should be grounded. The operator should be grounded using wrist strap. Semiconductor devices must not be touched with bare hands. Similar precautions need to be taken for PW boards with semiconductor devices on it.

② HANDLING OF UNUSED INPUT PINS FOR CMOS

Note:

No connection for CMOS device inputs can be cause of malfunction. If no connection is provided to the input pins, it is possible that an internal input level may be generated due to noise, etc., hence causing malfunction. CMOS devices behave differently than Bipolar or NMOS devices. Input levels of CMOS devices must be fixed high or low by using a pull-up or pull-down circuitry. Each unused pin should be connected to V_{DD} or GND with a resistor, if it is considered to have a possibility of being an output pin. All handling related to the unused pins must be judged device by device and related specifications governing the devices.

③ STATUS BEFORE INITIALIZATION OF MOS DEVICES

Note:

Power-on does not necessarily define initial status of MOS device. Production process of MOS does not define the initial operation status of the device. Immediately after the power source is turned ON, the devices with reset function have not yet been initialized. Hence, power-on does not guarantee out-pin levels, I/O settings or contents of registers. Device is not initialized until the reset signal is received. Reset operation must be executed immediately after power-on for devices having reset function.

CAUTION FOR HANDLING MEMORY MODULES

When handling or inserting memory modules, be sure not to touch any components on the modules, such as the memory IC, chip capacitors and chip resistors. It is necessary to avoid undue mechanical stress on these components to prevent damaging them.

When re-packing memory modules, be sure the modules are NOT touching each other. Modules in contact with other modules may cause excessive mechanical stress, which may damage the modules.

- The information in this document is current as of September, 2000. The information is subject to change without notice. For actual design-in, refer to the latest publications of Elpida's data sheets or data books, etc., for the most up-to-date specifications of Elpida semiconductor products. Not all products and/or types are available in every country. Please check with an Elpida Memory, Inc. for availability and additional information.
- No part of this document may be copied or reproduced in any form or by any means without prior written consent of Elpida. Elpida assumes no responsibility for any errors that may appear in this document.
- Elpida does not assume any liability for infringement of patents, copyrights or other intellectual property rights of third parties by or arising from the use of Elpida semiconductor products listed in this document or any other liability arising from the use of such products. No license, express, implied or otherwise, is granted under any patents, copyrights or other intellectual property rights of Elpida or others.
- Descriptions of circuits, software and other related information in this document are provided for illustrative purposes in semiconductor product operation and application examples. The incorporation of these circuits, software and information in the design of customer's equipment shall be done under the full responsibility of customer. Elpida assumes no responsibility for any losses incurred by customers or third parties arising from the use of these circuits, software and information.
- While Elpida endeavours to enhance the quality, reliability and safety of Elpida semiconductor products, customers agree and acknowledge that the possibility of defects thereof cannot be eliminated entirely. To minimize risks of damage to property or injury (including death) to persons arising from defects in Elpida semiconductor products, customers must incorporate sufficient safety measures in their design, such as redundancy, fire-containment, and anti-failure features.
- Elpida semiconductor products are classified into the following three quality grades:
"Standard", "Special" and "Specific". The "Specific" quality grade applies only to semiconductor products developed based on a customer-designated "quality assurance program" for a specific application. The recommended applications of a semiconductor product depend on its quality grade, as indicated below. Customers must check the quality grade of each semiconductor product before using it in a particular application.
"Standard": Computers, office equipment, communications equipment, test and measurement equipment, audio and visual equipment, home electronic appliances, machine tools, personal electronic equipment and industrial robots
"Special": Transportation equipment (automobiles, trains, ships, etc.), traffic control systems, anti-disaster systems, anti-crime systems, safety equipment and medical equipment (not specifically designed for life support)
"Specific": Aircraft, aerospace equipment, submersible repeaters, nuclear reactor control systems, life support systems and medical equipment for life support, etc.
The quality grade of Elpida semiconductor products is "Standard" unless otherwise expressly specified in Elpida's data sheets or data books, etc. If customers wish to use Elpida semiconductor products in applications not intended by Elpida, they must contact an Elpida Memory, Inc. in advance to determine Elpida's willingness to support a given application.
(Note)
(1) "Elpida" as used in this statement means Elpida Memory, Inc. and also includes its majority-owned subsidiaries.
(2) "Elpida semiconductor products" means any semiconductor product developed or manufactured by or for Elpida (as defined above).