

Fixed 3.3V High Output Charge Pump Buck/Boost Regulator

POWER MANAGEMENT

Features

- Input voltage range — 2.9V to 5.5V
- V_{OUT} tolerance $3.3V \pm 3\%$
- V_{OUT} regulation (line + load) $\pm 2\%$
- Continuous output current — 400mA
- Peak output current — 500mA
- Three charge pump modes — 1x, 1.5x and 2x
- Output ripple $\leq 20mV_{pp}$ for $I_{OUT} \leq 400mA$
- Short circuit, over-voltage, and over-temperature protection
- Soft-start functionality
- Shutdown current — $0.1\mu A$, typical
- Ultra thin package — $2 \times 2 \times 0.6$ (mm)
- Fully WEEE and RoHS compliant

Applications

- Mobile phones
- MP3 players
- Multi-LED backlit LCDs
- Compact flash/CF+ products
- PMPs
- Digital video cameras
- Digital still cameras
- PDAs

Description

The SC630 is a high-current voltage regulator using Semtech's proprietary low-noise charge pump technology. Performance is optimized for use in single Li-Ion battery cell applications. The regulator provides the performance of a linear, low drop-out (LDO) voltage regulator when the battery is greater than 3.3V. Unlike an LDO, drop-out is avoided when the battery is less than 3.3V. Instead, a charge pump is activated to provide voltage boost — the head-room needed for voltage regulation.

Only two $2.2\mu F$ bucket capacitors are required to deliver the full output current. The charge pump provides a low EMI solution compared to inductive buck/boost regulators.

The SC630's charge pump has three modes of operation: 2x, 1.5x, and 1x modes. The 2x and 1.5x modes deliver current to the load in each of two phases. The 1x mode turns off the charge pump, delivering current through an LDO. When active, the charge pump provides low-ripple operation at 200kHz, which is typically less than $20mV_{pp}$ at the output. The SC630 is capable of delivering 400mA continuous current, with peak current to 500mA. A $22\mu F$ output capacitor of is used for decoupling the load and for smoothing mode transitions. Hysteresis is provided to prevent chatter between charge pump modes.

The micro lead-frame package is both small and thermally efficient, measuring $2 \times 2 \times 0.6$ (mm).

Typical Application Circuit

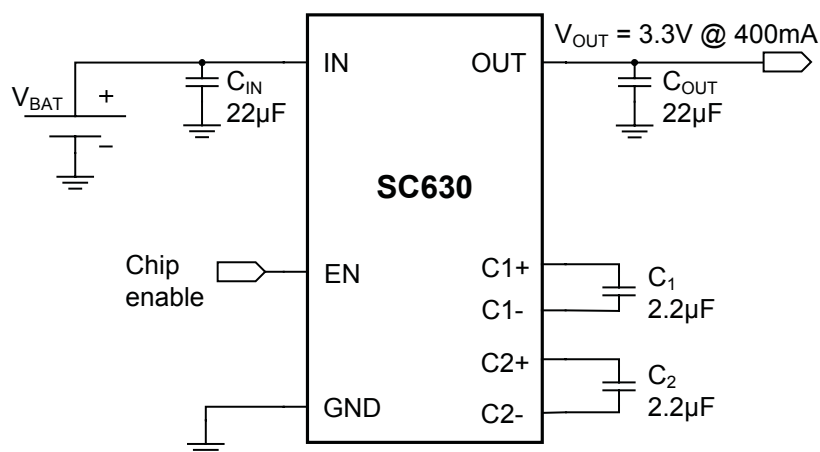

Patents Pending

Pin Configuration

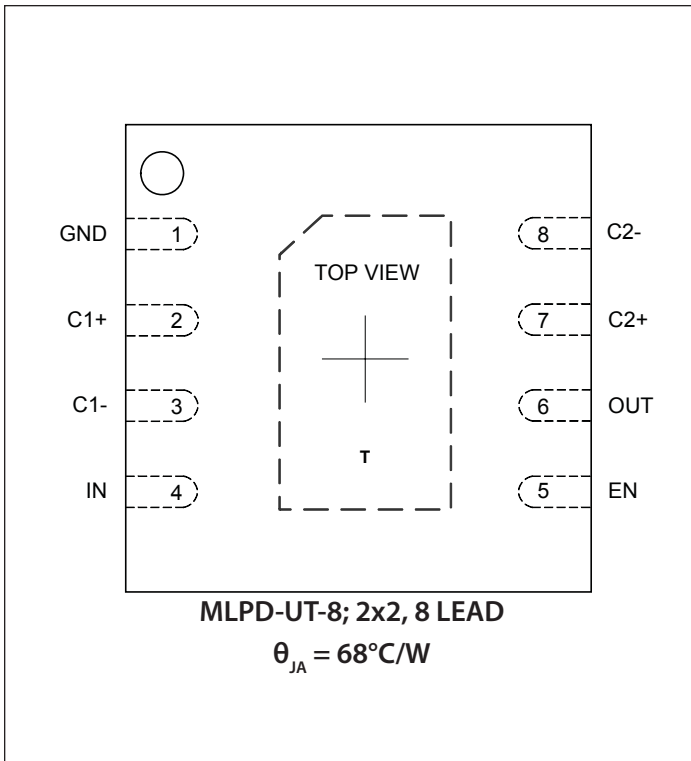

Ordering Information

Device	Package
SC630ULTRT ⁽¹⁾⁽²⁾	MLPD-UT-8 2x2
SC630EVB	Evaluation Board

Notes:

- (1) Available in tape and reel only. A reel contains 3,000 devices.
- (2) Lead-free package only. Device is WEEE and RoHS compliant.

Marking Information

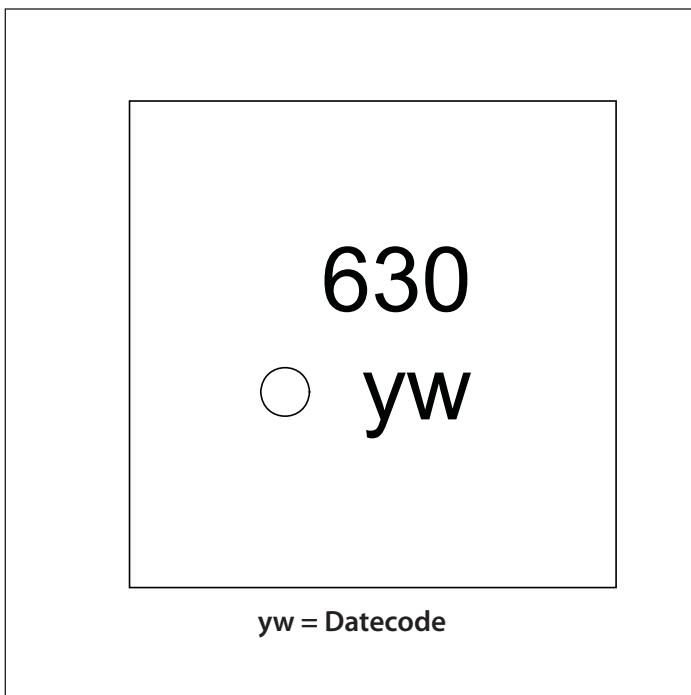

Absolute Maximum Ratings

IN, OUT (V)	-0.3 to +6.0
C1+, C2+ (V)	-0.3 to ($V_{OUT} + 0.3$)
Pin Voltage - All Other Pins (V)	-0.3 to ($V_{IN} + 0.3$)
OUT Short Circuit Duration	Continuous
ESD Protection Level ⁽¹⁾ (kV)	2

Recommended Operating Conditions

Ambient Temperature Range (°C)	$-40 \leq T_A \leq +85$
IN (V)	$2.9 \leq V_{IN} \leq 5.5$

Thermal Information

Thermal Resistance, Junction to Ambient ⁽²⁾ (°C/W)	68
Maximum Junction Temperature (°C)	+150
Storage Temperature Range (°C)	-65 to +150
Peak IR Reflow Temperature (10s to 30s) (°C)	+260

Exceeding the above specifications may result in permanent damage to the device or device malfunction. Operation outside of the parameters specified in the Electrical Characteristics section is not recommended.

NOTES

(1) Tested according to JEDEC standard JESD22-A114-B.

(2) Calculated from package in still air, mounted to 3 x 4.5 (in), 4 layer FR4 PCB with thermal vias under the exposed pad per JESD51 standards.

Electrical Characteristics

Unless otherwise specified: $T_A = +25^\circ\text{C}$ for Typ, -40°C to $+85^\circ\text{C}$ for Min and Max; $C_1 = C_2 = 2.2\mu\text{F}$ (ESR < 0.03Ω); $C_{IN} = C_{OUT} = 22\mu\text{F}$; $V_{IN} = 2.9\text{V}$ to 5.5V

Parameter	Symbol	Condition	Min	Typ	Max	Units
Input Supply Voltage	V_{IN}		2.9		5.5	V
Output Voltage	V_{OUT}	$V_{IN} = 4.2\text{V}, I_{OUT} = 1\text{mA}$	3.2	3.3	3.4	V
Output Voltage Ripple	V_{PP}	$I_{OUT} \leq 400\text{mA}$		20		mV
Maximum Output Current	I_{OUT}	Peak Load - thermally limited ⁽¹⁾ , $T_J < 150^\circ\text{C}, 2.85\text{V} \leq V_{IN} \leq 5.5\text{V}$	500			mA
		Continuous Load, $3.1\text{V} \leq V_{IN} \leq 5.5\text{V}$, 1x or 1.5x mode	400			mA
Shutdown Current	I_{SD}	Shutdown (EN = GND), $V_{IN} = 3.6\text{V}$		0.1	2	μA
Total Quiescent Current	I_Q	EN high, 1x mode, $I_{OUT} = 1\text{mA}, V_{IN} = 4.2\text{V}$		1.5	2.0	mA
		EN high, 1.5x or 2x mode, $I_{OUT} = 1\text{mA}, V_{IN} = 3.3\text{V}$		1.5	2.5	mA
Charge Pump Frequency	f_{PUMP}	$V_{IN} = 3.2\text{V}$	140	200	260	kHz
Start-Up Time	t_{SU}	(EN transitions from low to high), $3.2\text{V} \leq V_{OUT} \leq 3.4\text{V}$, No load		400		μs
Line Regulation	ΔV_{LINE}	$I_{OUT} = 1\text{mA}, 2.85\text{V} \leq V_{IN} \leq 4.2\text{V}$			21	mV
Load Regulation	ΔV_{LOAD}	V_{IN} Fixed, $1\text{mA} \leq I_{OUT} \leq 500\text{mA}$			25	mV

Electrical Characteristics (continued)

Parameter	Symbol	Condition	Min	Typ	Max	Units
EN Input High Threshold	V_{IH}	$V_{IN} = 5.5V$	1.6			V
EN Input Low Threshold	V_{IL}	$V_{IN} = 2.7V$			0.4	V
EN Input High Current	I_{IH}	$V_{IN} = 5.5V$			2	μA
EN Input Low Current	I_{IL}	$V_{IN} = 5.5V$			2	μA
Open-Loop Output Resistance	R_{OUT}	1x mode		0.3		Ω
		1.5x mode, $V_{IN} = 3.15V$		3		Ω
		2x mode, $V_{IN} = 2.93V$		2.4		Ω
Mode Transition Voltage ⁽²⁾	$V_{TRANS\ 1X}$	$I_{OUT} = 300mA$		3.3		V
	$V_{TRANS\ 1.5X}$	$I_{OUT} = 300mA$		2.93		V
Fault Protection						
Short-Circuit Current	I_{SC}	$V_{OUT} = 0V, I_{OUT} = I_{IN}$	300	600	980	mA
Input Current Limit	I_{LIMIT}	1x mode	0.6	1.2	2.0	A
		1.5x and 2x modes	1.2	2.0	2.8	A
		$V_{OUT} \leq 2V, I_{OUT} = I_{IN}$		700		mA
Over Temperature ⁽³⁾	T_{OTP}	Rising Threshold		165		$^{\circ}C$
	T_{HYS}	Hysteresis		20		$^{\circ}C$

Notes:

- (1) Thermal limitation is dependent upon the thermal performance of the printed circuit board in support of the package standard of 68 $^{\circ}C/W$.
- (2) Voltage at the IN pin where a mode transition takes place in the charge pump with V_{IN} falling.
- (3) Guaranteed by design - not tested in production.

Typical Characteristics

Load Regulation

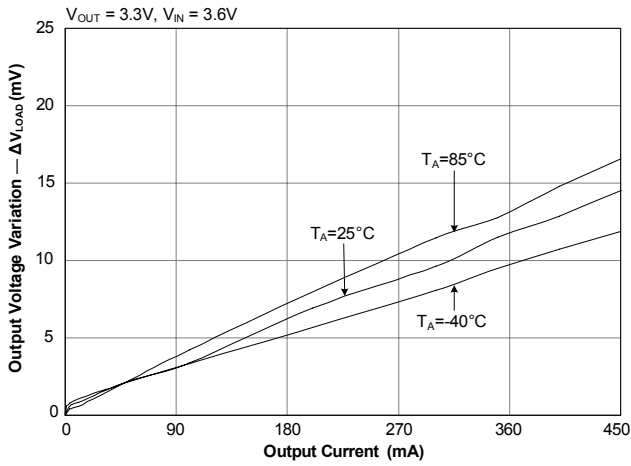

Line Regulation

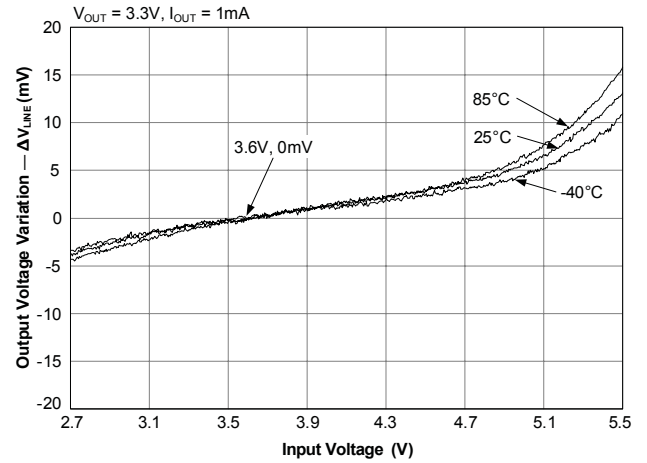

Efficiency versus Load Current

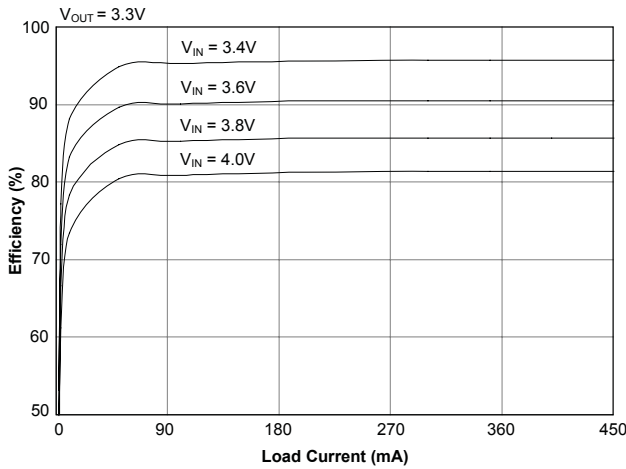

PSRR — 1x Mode

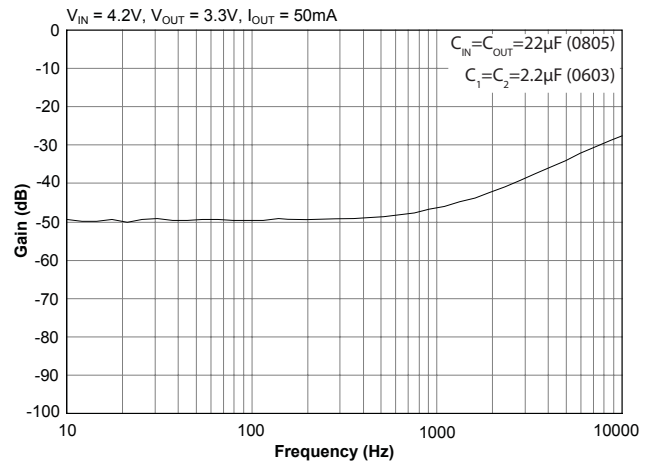

PSRR — 1.5x Mode

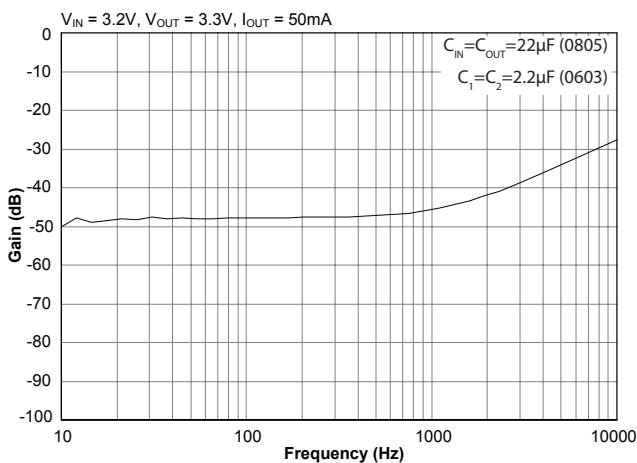

Typical Characteristics (continued)

Efficiency — 10mA

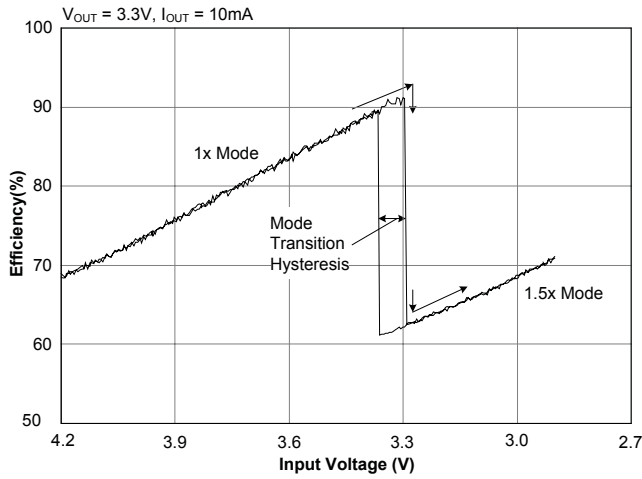

Efficiency — 50mA

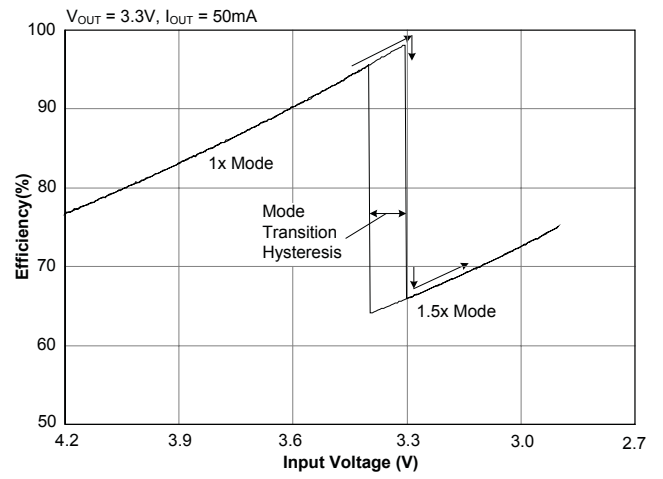

Efficiency — 100mA

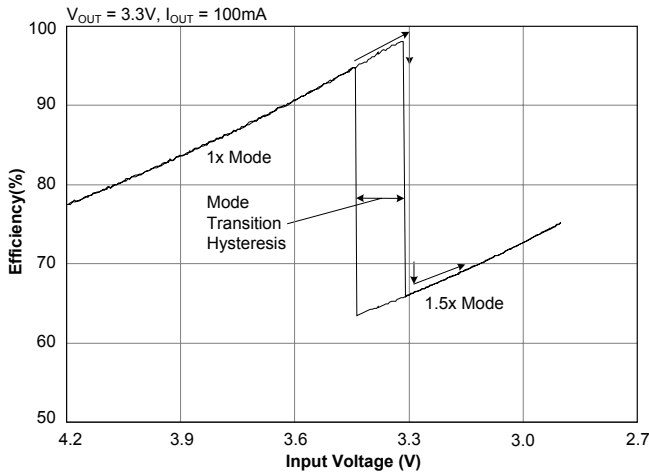

Efficiency — 200mA

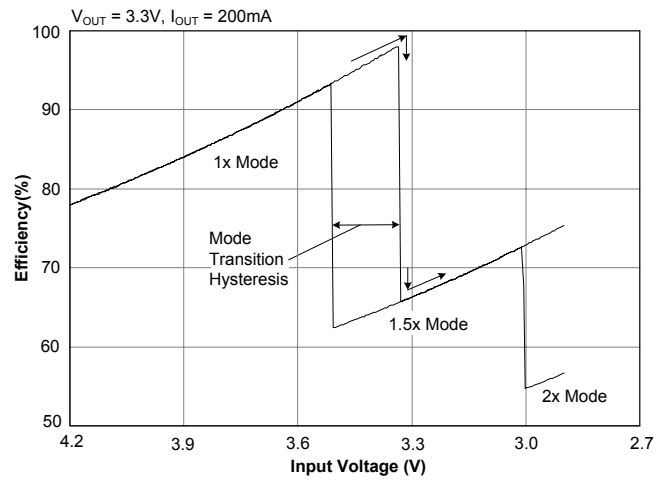

Efficiency — 300mA

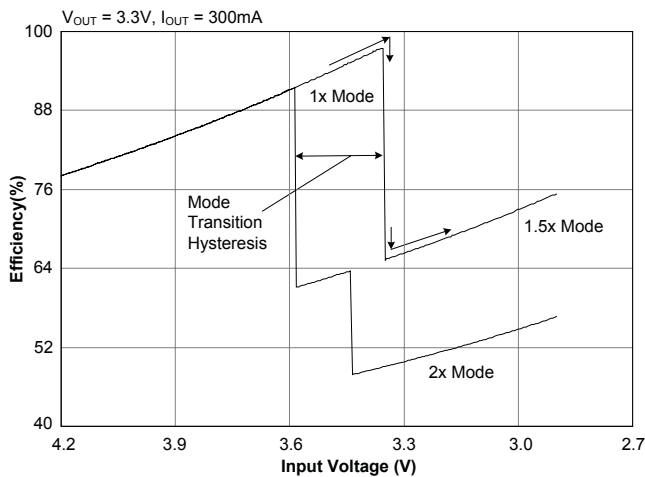

Efficiency — 400mA

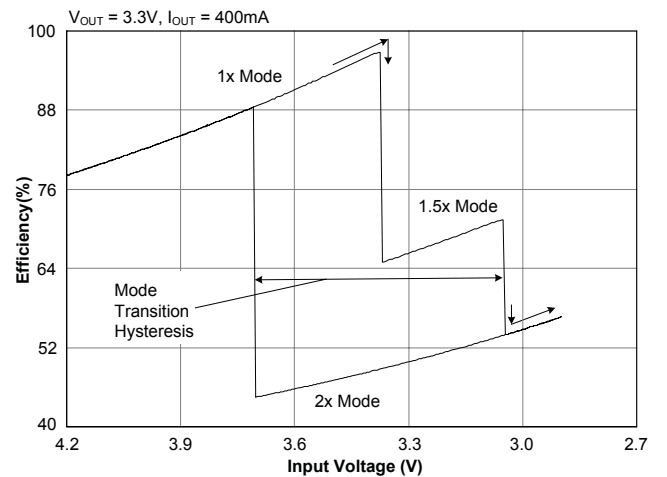

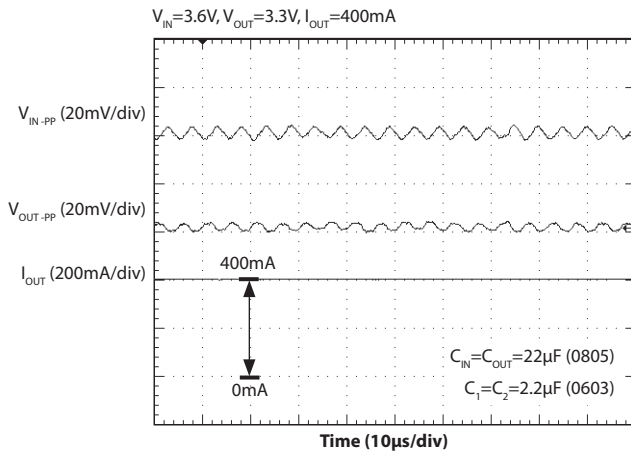
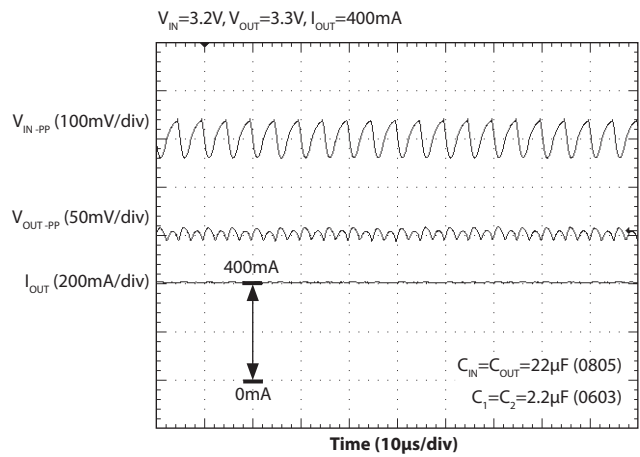
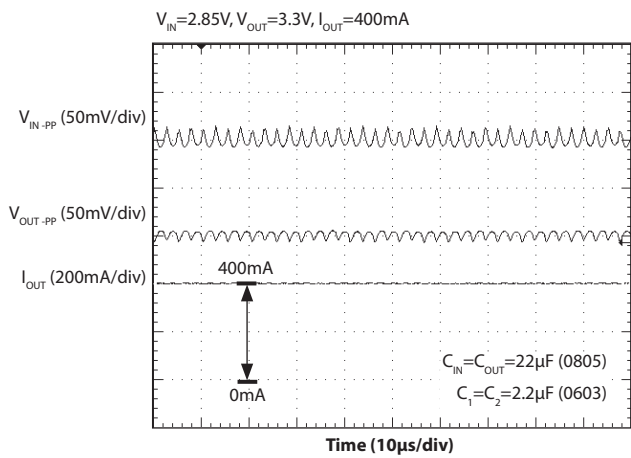
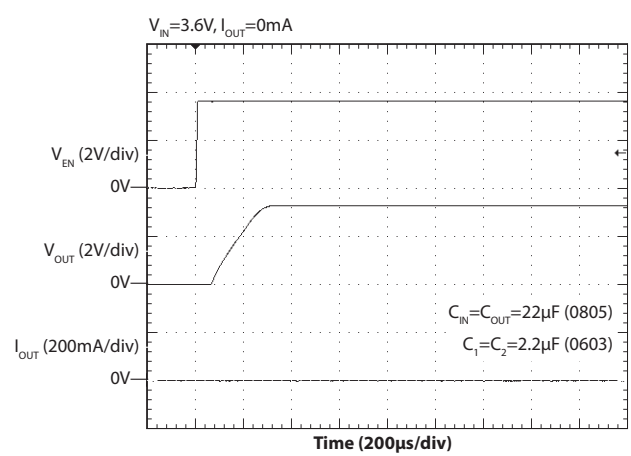
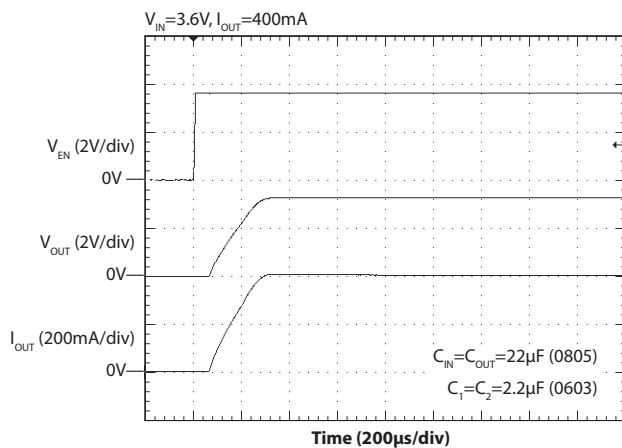
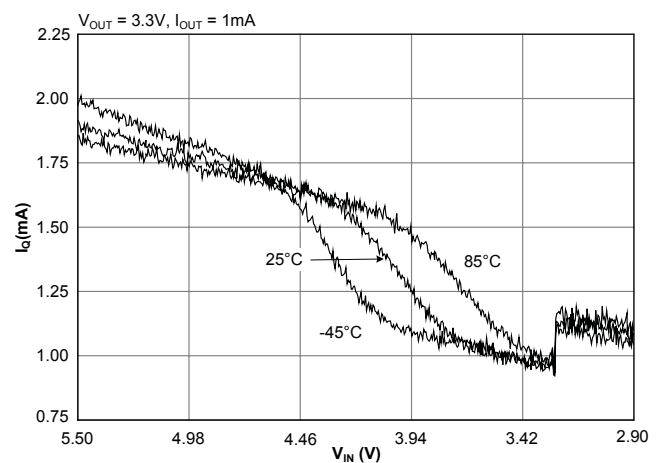
Typical Characteristics (continued)
Ripple — 1x Mode

Ripple — 1.5x Mode

Ripple — 2x Mode

Startup (No Load)

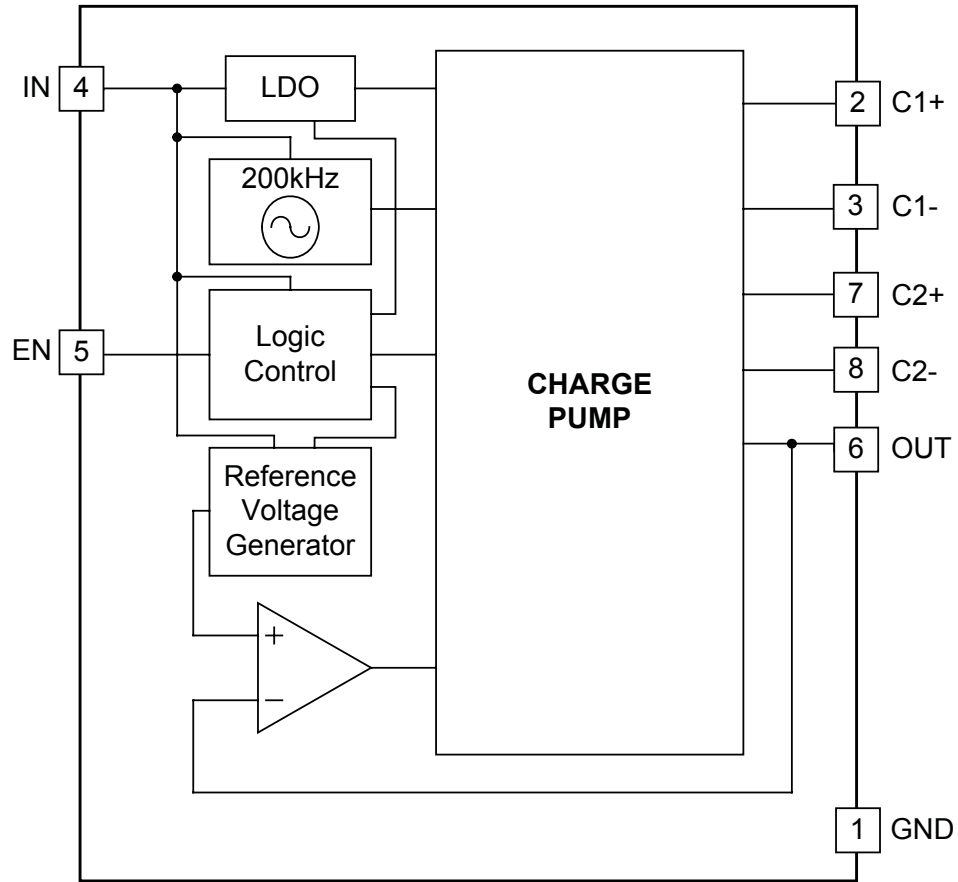
Startup (400mA)

Quiescent Current

Pin Descriptions

Pin	Pin Name	Pin Function
1	GND	Ground — connect to ground plane with multiple vias
2	C1+	Positive terminal of bucket capacitor 1
3	C1-	Negative terminal of bucket capacitor 1
4	IN	Input supply voltage
5	EN	Chip enable — active-high
6	OUT	Output
7	C2+	Positive terminal of bucket capacitor 2
8	C2-	Negative terminal of bucket capacitor 2
T	Thermal Pad	This pad is for heat sinking and is not connected internally. It must be connected to a ground plane using multiple vias.

Block Diagram



Applications Information

General Description

The SC630 is a 3.3V output charge pump regulator designed to support up to 400mA ($T_A \leq 85^\circ\text{C}$, $3.15\text{V} \leq V_{\text{IN}} \leq 5.5\text{V}$) of continuous current. It is used for powering Micro HDDs (Hard Disk Drives) and other 3.3V devices in portable handheld equipment including Compact Flash and CF+ products.

The SC630 has three operating modes — 1x, 1.5x, and 2x. The 1x mode is a linear series regulation mode with a low output resistance of only 300mΩ. The 1x mode functions as a low noise series linear regulator. The 1.5x and 2x modes are a low noise constant frequency, constant duty cycle switch mode, using two bucket capacitors. One bucket supports the full output current while the other bucket charges from the input. The two buckets exchange roles in the next phase, supplying continuous output current in both phases and reducing the need for a large output decoupling capacitor. The constant frequency, constant duty cycle operation also produces predictable constant frequency harmonics.

Mode Transition Hysteresis

Hysteresis is provided to prevent chatter between charge pump modes for input steps of up to 120mV. Decouple the input to prevent steps greater than 120mV, for optimum transient performance, when the input voltage reaches the mode transition thresholds.

Thermal Resistance

The SC630 package is thermally efficient when the circuit board layout connects the thermal pad through multiple vias to the ground plane. The thermal resistance is dependent upon the connection between the thermal pad and the ground plane. A layout that is done correctly should keep the junction temperature below the over-temperature limit while operating the SC630 within the specified electrical conditions. A poor layout may allow the junction temperature to reach the over temperature limit, so it is important to maintain adequate ground plane around the device to maximize heat transfer to the PCB.

Temperature Derating

The load current and battery voltage range of the application should be compared with the efficiency plots on

page 6 to determine if 2x mode is required by the application. The data provided in the following derating curve for 2x mode is based on the peak power dissipation that could occur while in 2x mode. 1x and 1.5x modes do not require derating.

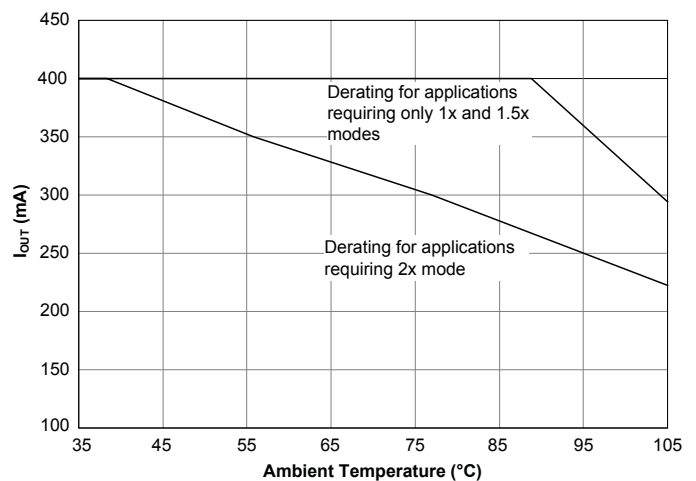

Maximum Continuous Output

Protection Circuitry

The SC630 also provides protection circuitry that prevents the device from operating in an unspecified state. These functions include:

- Over-Current Protection (OCP)
- Short-Circuit Current Protection (SCCP)
- Over-Temperature Protection (OTP)

Over-Current Protection

Over-current protection is provided to limit the output current. When V_{OUT} is greater than 2V, OCP limits the output to 1A typical. The threshold at 2V allows the device to recover from excessive voltage droop during an over current.

Short-Circuit Current Protection

Short-circuit current protection is provided to limit the current that can be sourced when the output is shorted to ground. When a short circuit forces V_{OUT} to drop below 2V, the SCCP detects the condition and limits the output current to 250mA (typical).

Applications Information (continued)

Over-Temperature Protection

The over-temperature circuit helps prevent the device from overheating and experiencing a catastrophic failure. When the junction temperature exceeds 165°C the device is disabled. It remains disabled until the junction temperature drops below this threshold. Hysteresis is included that prevents the device from re-enabling until the junction temperature is reduced by 20°C.

Capacitor Selection

The SC630 is designed to use low-ESR ceramic capacitors for the input and output bypass capacitors as well as the charge pump bucket capacitors. Ideal performance is achieved when the bucket capacitors are exactly equal. The value of input and output decoupling capacitors will vary with system requirements. C_{IN} and C_{OUT} are normally 22 μ F and the bucket capacitors C_1 and C_2 are 2.2 μ F. For low profile designs, two parallel 10 μ F capacitors may be used in place of each 22 μ F.

For applications with load currents below 100 mA, the bucket capacitors may be reduced to 1 μ F and the input and output capacitors may be reduced to 10 μ F. The following table lists recommended capacitor values. Note that the smallest available capacitor packages have very poor DC voltage characteristics. 0402 and 0603 size capacitors may be as low as 50% of rated value at 3.3V.

The following capacitors are recommended for best performance. Use only X5R ceramic with a voltage rating of 6.3V or higher.

Table 1 — Recommended Capacitors

Capacitor	Value μ F	Case Size	Notes
C_{IN}, C_{OUT}	22	0805	Typical output $V_{pp} \leq 20$ mV in all charge pump modes Typical input ripple ≤ 100 mV in all charge pump modes
C_{IN}, C_{OUT}	10	0805	Typical performance is similar to the 22 μ F if 0805 capacitor size is used, due to the weaker DC voltage coefficient of the 22 μ F 0805.
C_{IN}, C_{OUT}	10	0603	Typical output V_{pp} as high as 75mV in boosting charge pump modes Typical input ripple as high as 175mV in boosting charge pump modes For a lower profile design, two 10 μ F 0603's may be substituted in place of one 10 μ F or 22 μ F 0805. Two are needed, due to the weaker DC voltage coefficient of the 0603 package size.
C_{BUCKET}	2.2	0603	Required for the full rated output current
C_{BUCKET}	2.2	0402	Useful for load current up to 300mA
C_{BUCKET}	1.0	0402	Useful for load current up to 100mA

NOTE: Use only X5R type capacitors, with a 6.3V rating or higher

The highest capacitance values in the smallest package sizes tend to have poor DC voltage characteristics. The highest value 0402 size capacitor retains as little as 35% of its rated value at 5VDC. The same value chosen in the next larger package size (0603) retains about 60% of its rated value at 5VDC.

Applications Information (continued)

PCB Layout Considerations

Poor layout can degrade the performance of the regulator and can be a contributory factor in EMI problems, ground bounce, thermal issues, and resistive voltage losses. Poor regulation and instability can result.

The following design rules are recommended:

1. Place the bucket capacitors as close to the device as possible and on the same side of the board. Use short wide copper areas between the capacitor pins and the device pins.
2. Place the input and output decoupling capacitors as close as possible to the device and connect these capacitors' ground pads together to the ground plane using multiple vias through a short wide copper area.
3. Connect pin 1 directly to the copper area under the thermal pad.
4. The thermal pad at the center of the device is not electrically connected. Connect this pad to the ground plane using multiple vias.
5. Use a ground plane to further reduce noise interference on sensitive circuit nodes.

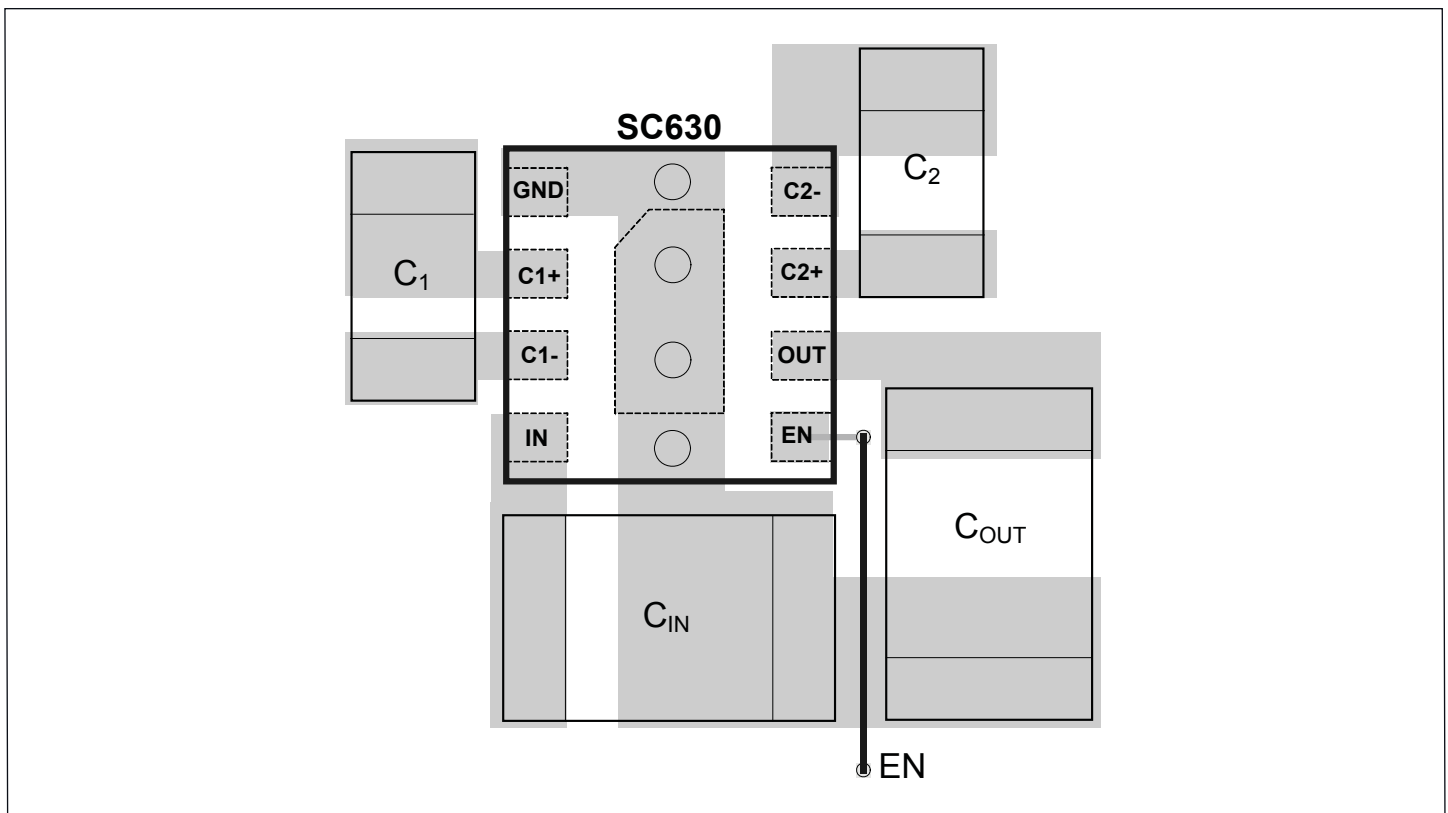

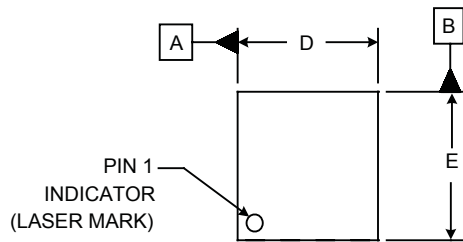
Outline Drawing — MLPD-UT-8 2x2

DIM	DIMENSIONS					
	INCHES			MILLIMETERS		
	MIN	NOM	MAX	MIN	NOM	MAX
A	.020	-	.024	0.50	-	0.60
A1	.000	-	.002	0.00	-	0.05
A2	(.006)			(0.1524)		
b	.007	.010	.012	0.18	0.25	0.30
D	.075	.079	.083	1.90	2.00	2.10
D1	.061	.067	.071	1.55	1.70	1.80
E	.075	.079	.083	1.90	2.00	2.10
E1	.026	.031	.035	0.65	0.80	0.90
e	.020 BSC			0.50 BSC		
L	.012	.014	.016	0.30	0.35	0.40
N	8			8		
aaa	.003			0.08		
bbb	.004			0.10		

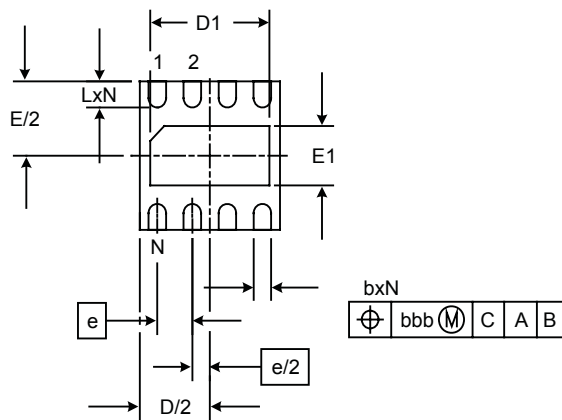
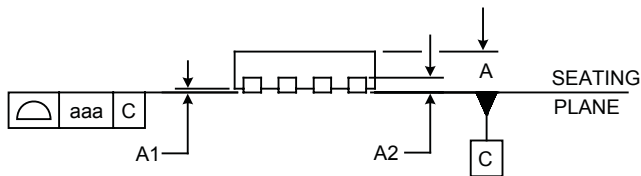
NOTES:

1. CONTROLLING DIMENSIONS ARE IN MILLIMETERS (ANGLES IN DEGREES).
2. COPLANARITY APPLIES TO THE EXPOSED PAD AS WELL AS THE TERMINALS.

Land Pattern — MLPD-UT-8 2x2

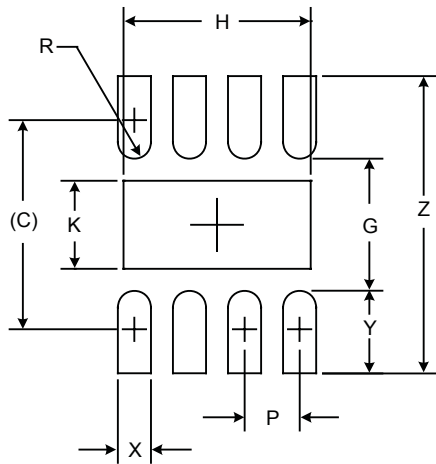

DIMENSIONS		
DIM	INCHES	MILLIMETERS
C	(.077)	(1.95)
G	.047	1.20
H	.067	1.70
K	.031	0.80
P	.020	0.50
R	.006	0.15
X	.012	0.30
Y	.030	0.75
Z	.106	2.70

NOTES:

1. CONTROLLING DIMENSIONS ARE IN MILLIMETERS (ANGLES IN DEGREES).
2. THIS LAND PATTERN IS FOR REFERENCE PURPOSES ONLY. CONSULT YOUR MANUFACTURING GROUP TO ENSURE YOUR COMPANY'S MANUFACTURING GUIDELINES ARE MET.
3. THERMAL VIAS IN THE LAND PATTERN OF THE EXPOSED PAD SHALL BE CONNECTED TO A SYSTEM GROUND PLANE. FAILURE TO DO SO MAY COMPROMISE THE THERMAL AND/OR FUNCTIONAL PERFORMANCE OF THE DEVICE.

Contact Information

Semtech Corporation
 Power Management Products Division
 200 Flynn Road, Camarillo, CA 93012
 Phone: (805) 498-2111 Fax: (805) 498-3804

www.semtech.com