

# 3M™ Pak 20 Wiremount Socket

2 mm × 2 mm for 1 mm Pitch Cable

1522 Series

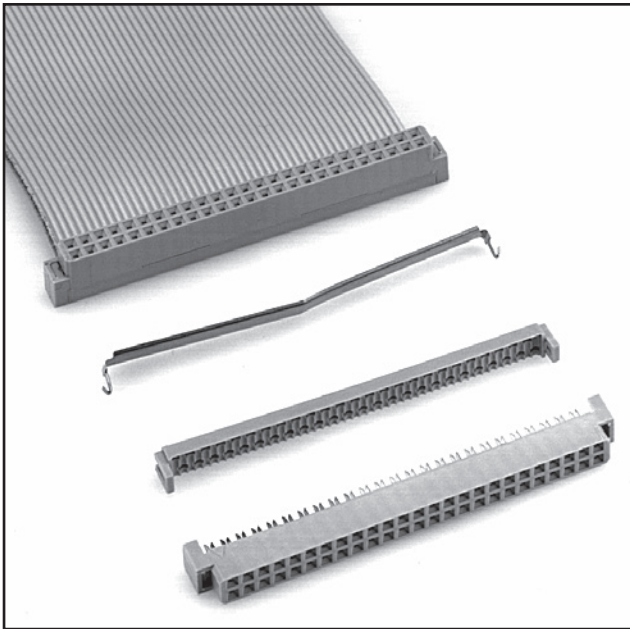

- Industry standard compatible
- Mates with Pak 20 (2 mm x 2 mm) grid pin strips
- Low profile
- Preassembled covers
- Available with or without strain relief
- Available with optional centerbump polarity feature
- See the Regulatory Information Appendix (RIA) in the “RoHS compliance” section of [www.3mconnector.com](http://www.3mconnector.com) for compliance information (RIA E1 & C1 apply)

Date Modified: April 15, 2010

TS-0523-C  
Sheet 1 of 3

## Physical

### Insulation:

Material: Glass Filled Polyester (PBT)

Flammability: UL 94V-0

Color: Gray

### Contact:

Material: Copper Alloy

### Plating:

Underplating and U-Slot: 50 -150 μ” [ 1.27-3.81 μm ] Nickel - QQ-N-290, Class 2

Wiping Area: Gold, MIL-G-45204, Type II, Grade C

Wire Accommodation: 28 AWG Stranded

**Marking:** 3M Logo, Part Identification Number and Orientation Triangle

Note: The location and thickness of the contact plating is determined by the part number. Refer to ordering information.

## Electrical

**Current Rating:** 1A

**Insulation Resistance:**  $> 1 \times 10^9 \Omega$  at 500 V<sub>DC</sub>

**Withstanding Voltage:** 1,000 V<sub>RMS</sub> at Sea Level

## Environmental

**Temperature Rating:** -55°C to +105°C

UL File No.: E68080

RoHS = Directive 2002/95/EC,  
Restriction of the Use of Certain Hazardous Substances in Electrical and Electronic Equipment

# 3M™ Pak 20 Wiremount Socket

2 mm × 2 mm for 1 mm Pitch Cable

1522 Series

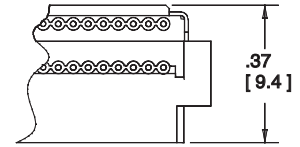
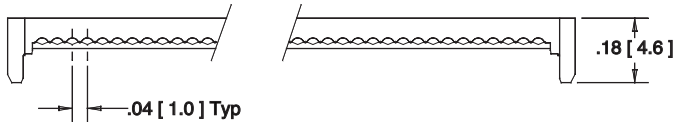
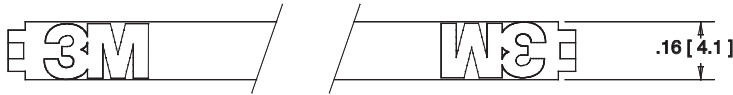

**Assembled Height with Strain Relief**

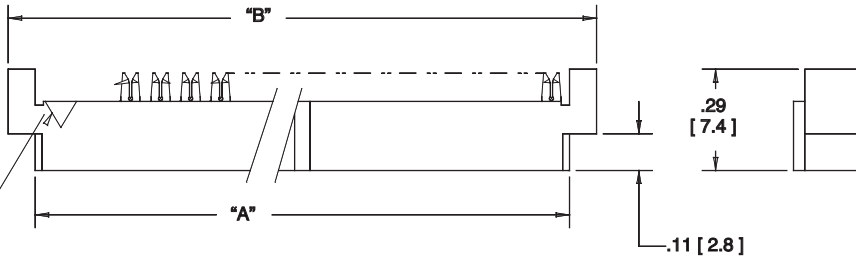

Delta Indicates Position No. 1

Optional Center Bump Polarity Feature

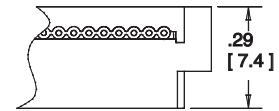
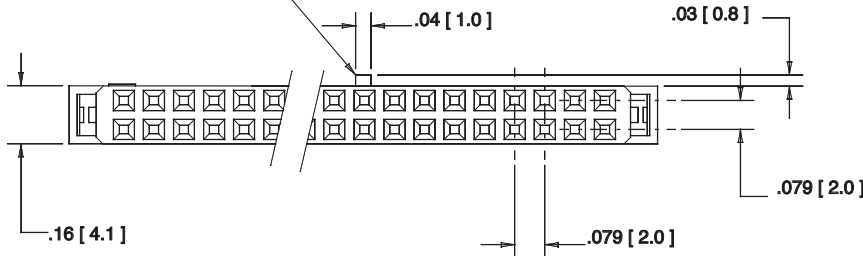

**Assembled Height without Strain Relief**

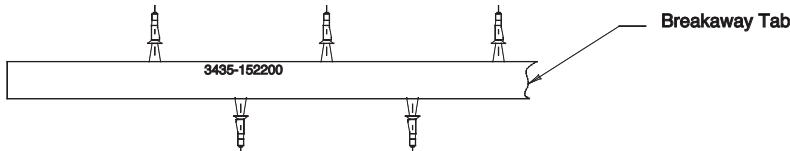

**Keying Plug (Optional, Order Separately)**

Inch (mm)		
Tolerance Unless Noted		
.0	.00	.000
Inch	±.1	±.01 ±.005

[ ] Dimensions for Reference only

## Ordering Information

**Socket**  
**1522XX - 0XXXXX** RIA (E1 & C1 Apply)

Contact Quantity: \_\_\_\_\_  
 (See Table 1)

- 0 = Preassembled Closed Cover, on even row side
- 1 = Preassembled Open Cover
- 2 = Preassembled Closed Cover, on odd row side

- 0 = No Polarization
- 1 = Center Bump

- Plating
- GB = 30 μ" [ 0.76 μm ] Avg Gold
- GG = 15 μ" [ 0.38 μm ] Avg Gold

- 0 = No Strain Relief
- 3 = With Strain Relief

**Strain Relief**  
**3448-1522XX**

Contact Quantity \_\_\_\_\_  
 (See Table 1)

**Keying Plug**  
 3435-152200  
 Order Separately

Application Tools: 3640 press (or equivalent), 3443-118 locator plate, 3442-9 platen

TS-0523-C  
 Sheet 2 of 3

# 3M™ Pak 20 Wiremount Socket

2 mm × 2 mm for 1 mm Pitch Cable

1522 Series



Table 1		
Contact Quantity	Dimensions	
	A	B
10	.45 [ 11.4 ]	.59 [ 15.0 ]
12	.53 [ 13.4 ]	.67 [ 17.0 ]
20	.84 [ 21.3 ]	.99 [ 25.1 ]
26	1.08 [ 27.4 ]	1.22 [ 31.0 ]
40	1.63 [ 41.4 ]	1.77 [ 45.0 ]
44	1.79 [ 45.5 ]	1.93 [ 49.0 ]
50	2.03 [ 51.3 ]	2.17 [ 55.0 ]

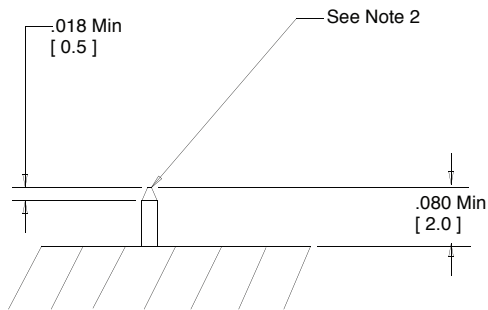

**Mating Pin Detail**

Inch (mm)			
Tolerance Unless Noted			
	.0	.00	.000
Inch	± .1	± .01	± .005

[ ] Dimensions for Reference only

TS-0523-C  
Sheet 3 of 3

**Important Notice**

All statements, technical information, and recommendations related to 3M's products are based on information believed to be reliable, but the accuracy or completeness is not guaranteed. Before using this product, you must evaluate it and determine if it is suitable for your intended application. You assume all risks and liability associated with such use. Any statements related to the product which are not contained in 3M's current publications, or any contrary statements contained on your purchase order shall have no force or effect unless expressly agreed upon, in writing, by an authorized officer of 3M.

**Warranty; Limited Remedy; Limited Liability.**

This product will be free from defects in material and manufacture for a period of one (1) year from the time of purchase. **3M MAKES NO OTHER WARRANTIES INCLUDING, BUT NOT LIMITED TO, ANY IMPLIED WARRANTY OF MERCHANTABILITY OR FITNESS FOR A PARTICULAR PURPOSE.** If this product is defective within the warranty period stated above, your exclusive remedy shall be, at 3M's option, to replace or repair the 3M product or refund the purchase price of the 3M product. **Except where prohibited by law, 3M will not be liable for any indirect, special, incidental or consequential loss or damage arising from this 3M product, regardless of the legal theory asserted.**

**3M Electronics Solutions Division**

6801 River Place Blvd.  
Austin, TX 78726-9000  
U.S.A.  
1-800-225-5373  
[www.3Mconnector.com](http://www.3Mconnector.com)

Please recycle. Printed in USA.  
© 3M 2010. All rights reserved.  
RIA-2217B-E

3M is a trademark of 3M Company.