

AZ DISPLAYS, INC.

COMPLETE LCD SOLUTIONS

SPECIFICATIONS FOR OLED DISPLAY

PART NUMBER:
DATE:

AZOLED034A & AZOLED034A-T
August 27, 2009

AZOLED034A

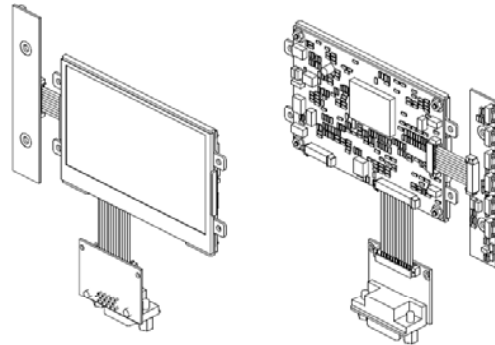

1. General Description

1.1 Features

- AZOLED034A ACTIVE OLED PANEL
- Ultra Compact
- NTSC/PAL/SECAM Video Auto Switch
- Single Operation Voltage +12V
- CVBS / S-Video (Option) / Analog RGB (PC Mode) Signal Input
- Support Touch Screen Function (option)

1.2 Applications

- Portable product
- Industrial
- Hand-held
- Security
- Instrument Display
- Office Electronics

1.3 Application Precautions

Do not use the products herein for the following equipment which demands extremely high performance in terms of functionality, reliability, or accuracy.

- Aerospace equipment
- Communication equipment for trunk lines.
- Control equipment for the nuclear power industry.
- Medical equipment related to life support, etc.

The other application that demands high reliability and functionality should first contact a sales representative.

2. Block Diagram

2.1 Block Diagram

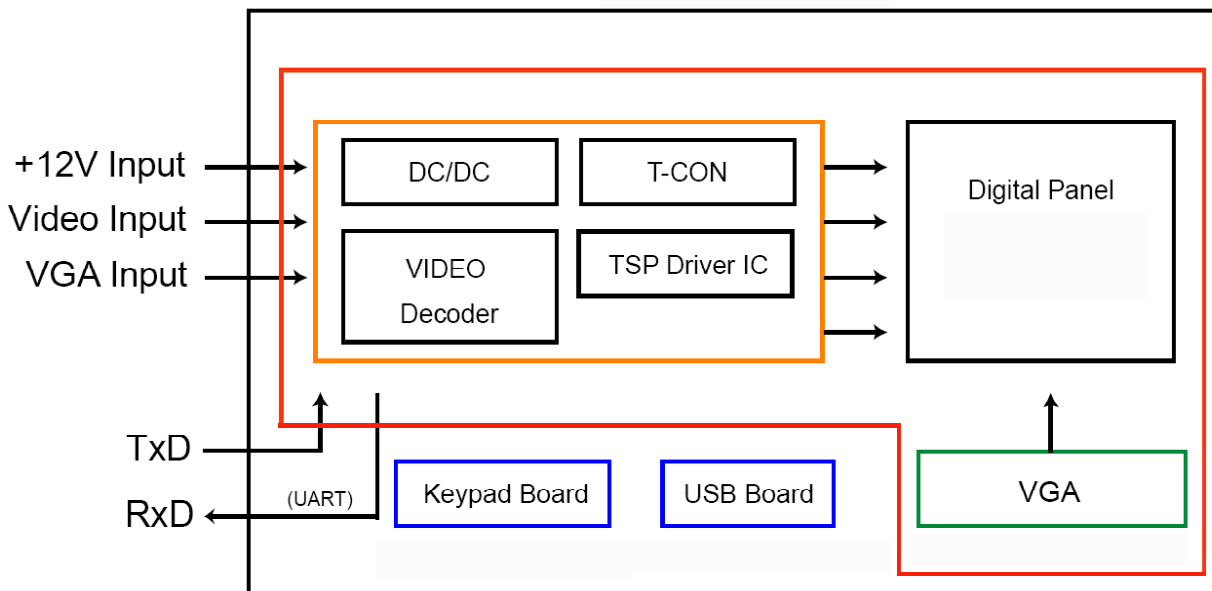
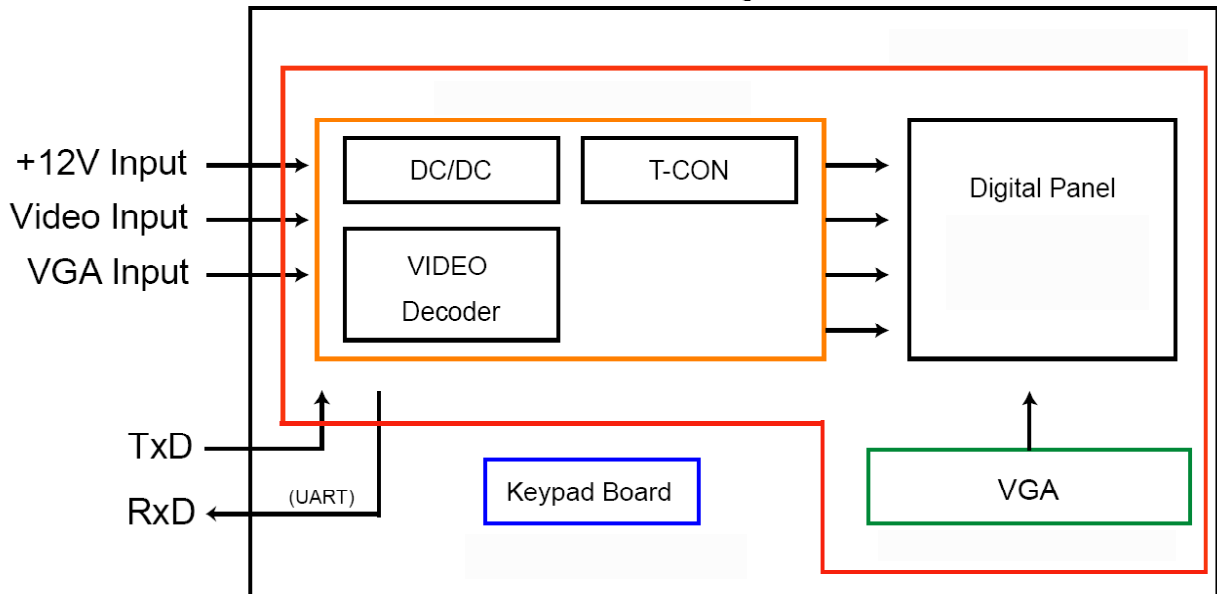

3. Panel Information

3.1 Panel Mechanical Specifications

Parameter	Specifications	Unit
Screen Size	3.4 (diagonal)	inch
Display Format	480 x (R.G.B) x 272	dot
Active Area	74.88(W) x 42.43 (H)	mm
Pixel Pitch	0.156(W) x 0.156(H)	mm
Pixel Configuration	Stripe	
Outline Area	82.8(W) x 54.3(H)	mm
Thickness	1.6	mm





3.2 Panel Optical Characteristics

Parameter	Symbol	Condition	Min	Typ	Max	Unit	Re
Viewing Angle	Horizontal	Left		170	---	deg	
		Right	CR >10	170	---		
	Vertical	Top		170	---	deg	
		Bottom		170	---	deg	
Contrast Ratio	CR	At optimized Viewing angle	5000:1	10000:1	---	---	
Response time	Rise Fall	Tr	---	---	---	---	
		Tf	$\square \theta = 0^\circ$	---	---	50	us
Uniformity	U		70	75	---	---	
Brightness			170	200	230		
White Chromaticity	x	$\square \theta = 0^\circ$	0.23	0.28	0.33		
	y	$\square \theta = 0^\circ$	0.25	0.30	0.35		
LED Life Time		25C	30000	---	---	Hr	

4.1 Panel Mechanical Specifications (With Touch)

Parameter	Specifications	Unit
Screen Size	3.4 (diagonal)	inch
Display Format	480 x (R.G.B) x 272	dot
Active Area	74.88(W) x 42.43 (H)	mm
Pixel Pitch	0.156(W) x 0.156(H)	mm
Pixel Configuration	Stripe	
Outline Area	82.8(W) x 54.3(H)	mm
Thickness	2.8	mm

4.2 Panel Optical Characteristics (With Touch)

Parameter	Symbol	Condition	Min	Typ	Max	Unit	Remark
Viewing Angle	Horizontal	Left		---	170	---	deg
		Right		---	170	---	
	Vertical	Top		---	170	---	deg
		Bottom		---	170	---	deg
Contrast Ratio	CR	At optimized Viewing angle	5000:1	10000:1	---	---	
Response time	Rise Fall	Tr		---	---	---	---
		Tf	$\theta = 0^\circ$	---	---	50	us
Brightness			136	160	184	cd/m ²	
White Chromaticity	x	$\theta = 0^\circ$	0.26	0.31	0.36		
	y	$\theta = 0^\circ$	0.28	0.33	0.38		
Operation life time		25°C	30000	---	---	Hr	

5. Dimension Information

5.1 Unit(AZOLED034A)

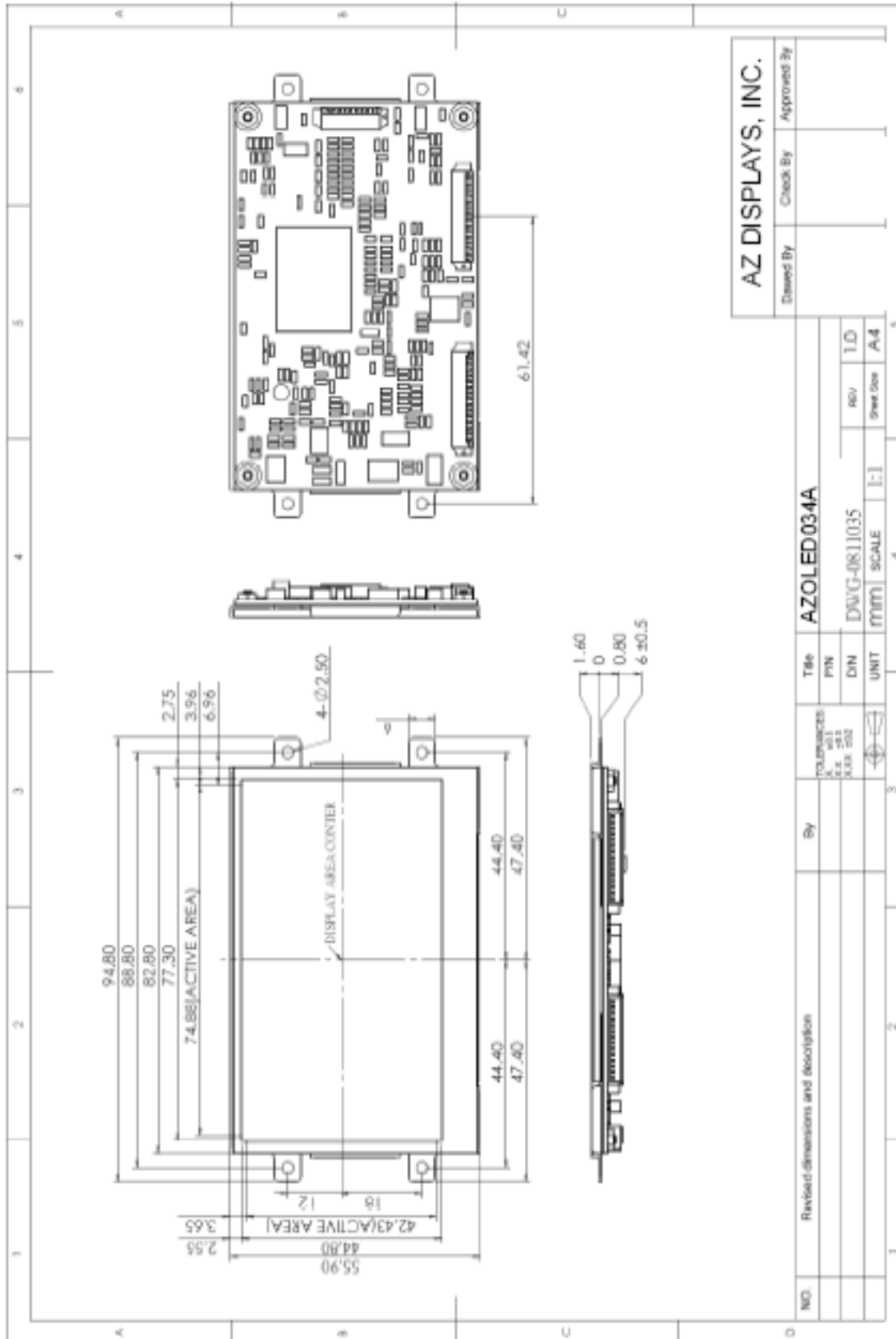

5.2 Unit (AZOLED034A-T)

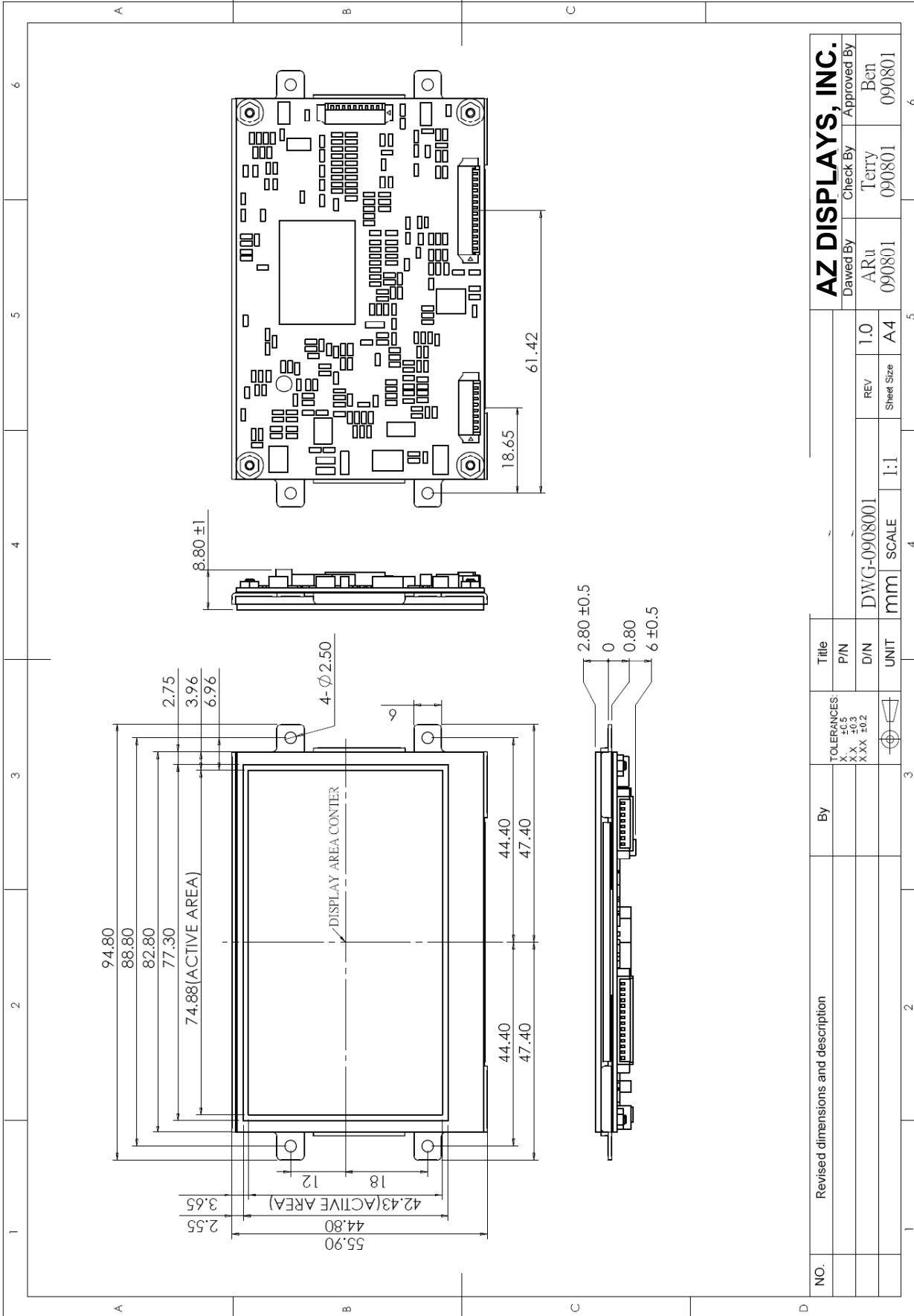

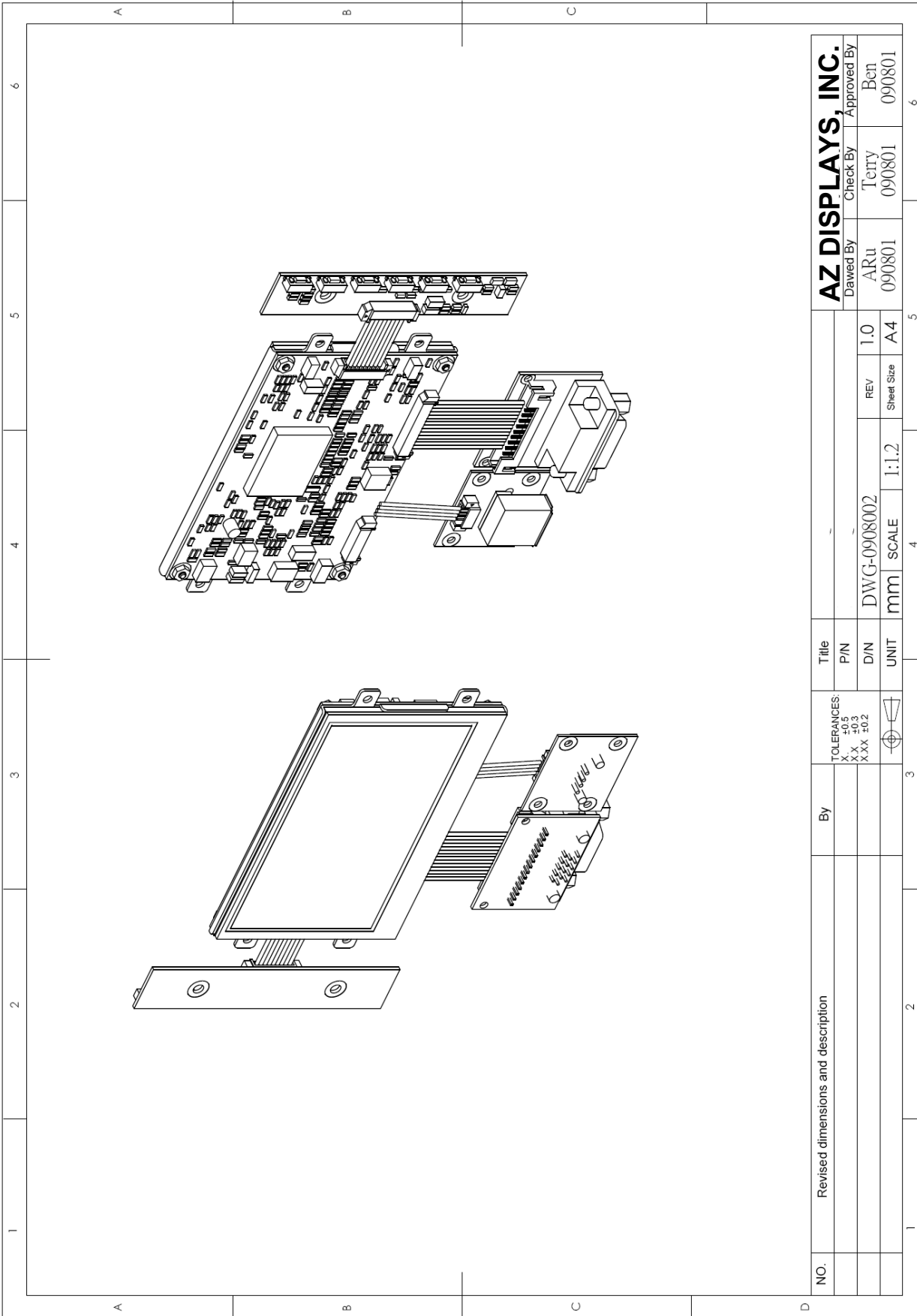

NO.	Revised dimensions and description	By	TOLERANCES: XXX ±0.3 XXX ±0.2	Title	AZ DISPLAYS, INC.		
			XXX ±0.2	P/N	Drawn By	Check By	Approved By
			XXX ±0.2	D/N	ARu	Terry	Ben
			XXX ±0.2	UNIT	090801	090801	090801
			XXX ±0.2		DWG-0908002	REV	1.0
			XXX ±0.2		mm	SCALE	A4
			XXX ±0.2		1:1.2	Sheet Size	A4

6. Pin Description

6.1 J301 OLED LCD Panel I/O Terminals(FPC 71 Pin Below Contact Type)

Pin No	Symbol	I/O	Description	Remark									
1	TP1	I	Touch panel P1										
2	TP2	I	Touch panel P2										
3	TP3	I	Touch panel P3.										
4	TP4	I	Touch panel P4										
5	AR_VSS	I	Negative voltage for OLED										
6	AR_VSS	I	Negative voltage for OLED										
7	TEST1_VS	open	CMEL test pin, it must be open.										
8	AR_VDD	I	Positive voltage for OLED										
9	AR_VDD	I	Positive voltage for OLED										
10	TEST2_VD	open	CMEL test pin, it must be open.										
11	ARREF	I/O	Panel refers voltage of the regulator ARREF or external input voltage.(-8V~+8V)										
12	VGL	I/O	Low Voltage output of regulator VGL or external input voltage.(-3V~-8V)										
13	VGH	I/O	High Voltage output of regulator VGH or external input voltage.(+3V~+8V)										
14	LVO	I/O	Negative output voltage of the booster2. (-8.5V)										
15	C22N	I/O	Connect to the step-up circuit, capacitors according to the step-up factor.										
16	C22P	I/O	Leave this pin open if the internal step-up circuit is not used.										
17	HVO	I/O	Positive output voltage of the booster2. (8.5V)										
18	C21P	I/O	Connect to the step-up circuit, capacitors according to the step-up factor.										
19	C21N	I/O	Leave this pin open if the internal step-up circuit is not used.										
20	C11N	I/O											
21	C11P	I/O	Connect to the step-up circuit, capacitors according to the step-up factor.										
22	C12N	I/O	Leave this pin open if the internal step-up circuit is not used.										
23	C12P	I/O											
24	PVSS	P	Charge pump ground pin, it must connect to external ground.										
25	DDVDH	I/O	Output voltage of the booster1. (5.1V/6.0V)										
26	VSSA	P	Analog ground pin. It must connect to external ground.										
27	VSSA	P	Analog ground pin. It must connect to external ground.										
28	VCI	P	A power supply for the Analog circuit. (3.0V~3.6V)										
29	VCI	P	A power supply for the Analog circuit. (3.0V~3.6V)										
30	VGAM1OUT	I/O	Output voltage of the VGAM1OUT regulator and used positive powerof source driver. (4.8V/5.8V)										
31		I/O	Internal logic voltage input or output pin VDC_ENB=0, VDDD is output, please connect to 1uF capacitor.										
			<table border="1"> <thead> <tr> <th>VDC0</th> <th>VDDD</th> <th>Status</th> </tr> </thead> <tbody> <tr> <td>0</td> <td>1.8</td> <td>Norml display</td> </tr> <tr> <td>1</td> <td>2.5</td> <td>OTP program</td> </tr> </tbody> </table>	VDC0	VDDD	Status	0	1.8	Norml display	1	2.5	OTP program	
VDC0	VDDD	Status											
0	1.8	Norml display											
1	2.5	OTP program											

			VDC_ENB=1, VDDD is input. (Input range = 1.6V~2.75V)
32	VCC	P	A power supply for the Digital circuit. (1.5V~3.6V)
33	VSSD	P	Digital ground pin. It must connect to external ground.
34	NRESET	I	Reset pin. Setting either pin low initializes the LSI. Must be reset after power is supplied. (Normally pull high)
35	NCS	I	Serial Interface chip enable pin. (Normally pull high)
36	SCL	I	Serial Interface clock input pin. (Normally pull high)
37	SDA	I	Serial Interface data line. (Normally pull high)
			Data enable:
38	DE	I	When VSYNC+HSYNC+DE mode, DE=H: Data enable, DE=L: Data disable (Black). (Normally pull low)
			Frame synchronizing signal.
39	VSYNC	I	If VSPL=0: Active low. If VSPL=1: Active high.
			Line synchronizing signal.
40	HSYNC	I	If HSPL=0: Active low. If HSPL=1: Active high.
41	DCLK	I	Dot clock signal. If DPL=0: Data are input on the rising edge of DOTCLK. If DPL=1: Data are input on the falling edge of DOTCLK.
42	D27	I	Digital data input. DX0 is LSB and DX7 is MSB. (Normally pull low)
43	D26		1. If parallel RGB input mode is used, D0X, D1X, and D2X indicate R, G, and
44	D25		B data in turn.
45	D24		2. If serial RGB or RGBD or CCIR601 or CCIR656 input mode is selected,
46	D23		only D07~D00 are used, and others short to GND. DX7~DX0 has 8-bit
47	D22		width, respectively to compose 16,777,216 color and 256 gray scale of 1
48	D21		pixel.
49	D20		
50	D17		
51	D16		
52	D15		
53	D14		
54	D13		
55	D12		
56	D11		
57	D10		
58	D07		
59	D06		
60	D05		
61	D04		
62	D03		
63	D02		

64	D01		
65	D00		
66	TEST3_W	open	C MEL test pin, it must be open.
67	AR_VDD	I	Positive voltage for OLED
68	AR_VDD	I	Positive voltage for OLED
69	AR_VSS	I	Negative voltage for OLED
70	AR_VSS	I	Negative voltage for OLED
71	TEST4_P	open	C MEL test pin, it must be open.

6.2 J101 Pin Assignment of Analog RGB Input (D-Sub 15 Pin)

Pin No	Symbol	I/O	Description	Remark
1	NC	-	No Connection	
2	NC	-	No Connection	
3	NC	-	No Connection	
4	GND	-	Ground	
5	NC	-	No Connection	
6	VS_IN	I	TTL Vertical sync	
7	HS_IN	I	TTL Horizontal sync	
8	AGND	-	Analog Ground	
9	RI+	I	Analog Red Signal	
10	AGND	-	Analog Ground	
11	GI+	I	Analog Green Signal	
12	AGND	-	Analog Ground	
13	BI+	I	Analog Blue Signal	
14	GND	-	Ground	

6.3 J105 Pin Assignment of Key (Pitch 1.25mm 9Pin, Side Entry Type)

Pin No	Symbol	I/O	Description	Remark
1	N.C	-	No Connection	
2	KEY-ADC1	I	KEY ADC Input 1	
3	KEY-ADC0	I	KEY ADC Input 0	
4	GND	-	Ground	
5	VDD	-	+3.3V Output Voltage	
6	IR_DATA	I	DATA of IR Receiver	
7	LED-R	O	Index Red LED for power off control	
8	LED-G	O	Index Green LED for power on control	
9	GND	-	Ground	

6.4 J102C Pin Assignment of Signal Input (Pitch 1.25mm 15Pin, Side Entry Type)

1	VCC12V	-	+12V Input Voltage	
2	VCC12V	-	+12V Input Voltage	
3	GND_D	-	Ground	
4	GND_D	-	Ground	
5	VIDEO1	I	Video1 Input Signal	
6	GND_A	-	Ground For Video1	
7	VIDEO2	I	Video2 Input Signal	
8	GND_A	-	Ground For Video2	
9	N.C	-	No Connection	
10	AGND	-	Analog Ground	
11	S1_Y+	I	Analog Luma Input of S-Video1	
12	GND	-	Ground for Analog Luma Input of S-Video1	
13	S1_C+	I	Analog Chroma Input of S-Video1	
14	GND	-	Ground for Analog Chroma Input of S-Video1	
15	GND_D	-	Ground	

7. Absolute Maximum Ratings

7.1 Absolute Maximum Ratings

Parameter	Symbol	Min	Max	Unit	Remark
Input Voltage	Vin □	+10	+14	V	
Video Input Signal	Video in	0.5	2.0	Vp-p	@75
S-Video Input Signal	S-Video in	0.5	2.0	Vp-p	@75
Analog RGB Input Signal	Analog RGB in	0.5	2.0	Vp-p	@75
Digital Input Signal	TTL □	+0.3	+3.6	V	
Operating Temperature		-10	+60	C	
Storage Temperature	□□	-20	+70	C	

8. Recommended operating conditions

8.1 Electrical Characteristics

Parameter	Symbol	I/O	Min	Typ	Max	Unit	Note
Input Voltage	Vin	I	+11	+12	+13	V	
Total Current	Iin	I		195		mA	
Power Consumption		I		2.3		W	@+12V
Output Voltage	VDD	O	+3.2	+3.3	+3.4	V	I=10mA
Video Input Signal	Video in	I		1.0		Vp-p	@75
S-Video Input Signal	S-Video in	Y		0.7		Vp-p	@75
		C		0.286		Vp-p	@75
Analog RGB Input Signal	Analog RGB in	RGB		0.7		Vp-p	@75

8.2 VGA Mode Characteristics

Dots per inch	Hor.	Unit	Polarity	Ver.	Unit	Polarity	Note
640*480	31.469	KHz	Negative	59.941	Hz	Negative	
800*600	37.879	KHz	Positive	60.317	Hz	Positive	

8.3 Optics Sample Test Data

Parameter	White Window	Red	Green	Blue	Remark
S/N 001 x	0.281	0.651	0.282	0.148	
.y	0.305	0.346	0.678	0.145	±15
L(cd/m ²)	349				
TC(°K)	9150				

BM-7 FAST(TOPCON)

2.Video Pattern Generator: FLUKE PM54200

3. Measurement Distance 500mm 50mm

4. TOPCON BM-7 Luminance Meter 2° filed of view is used in the testing

(After 10min ~20min operation)

9. Operation manual

9.1 Driver Board Manual

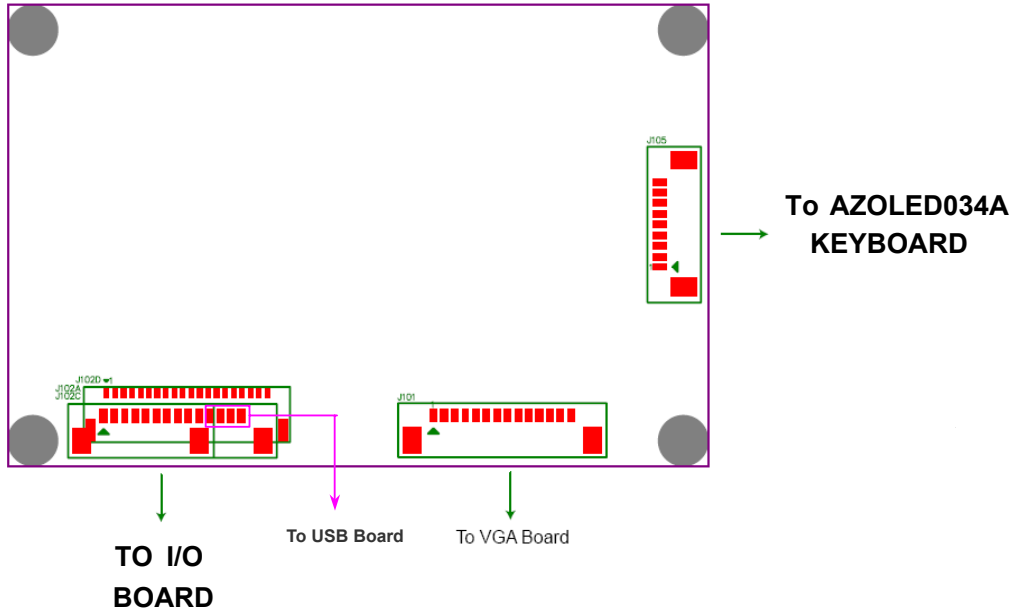

9.2 Power and RCA Input Board (Optional)

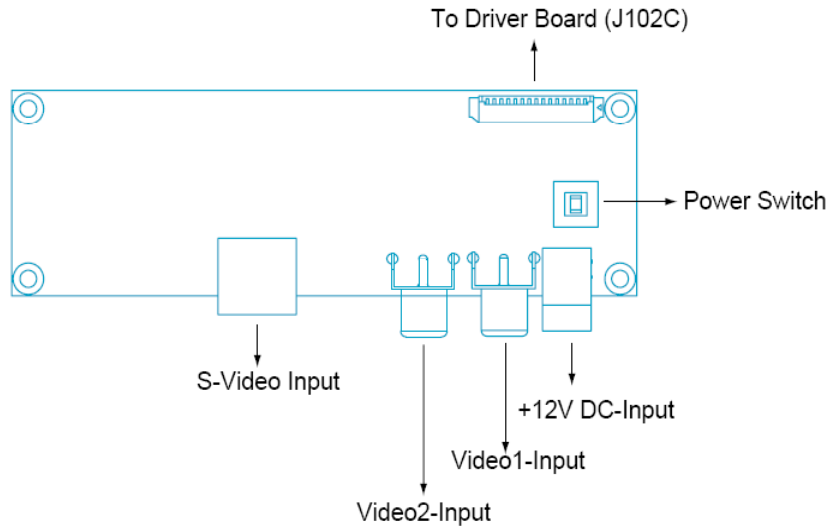

10. Key Function by OSD

10.1 Menu Operation

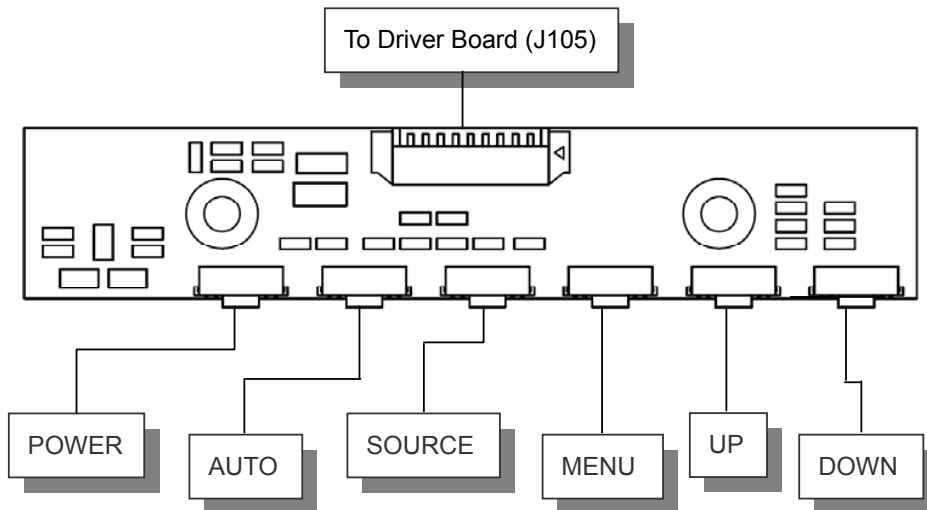
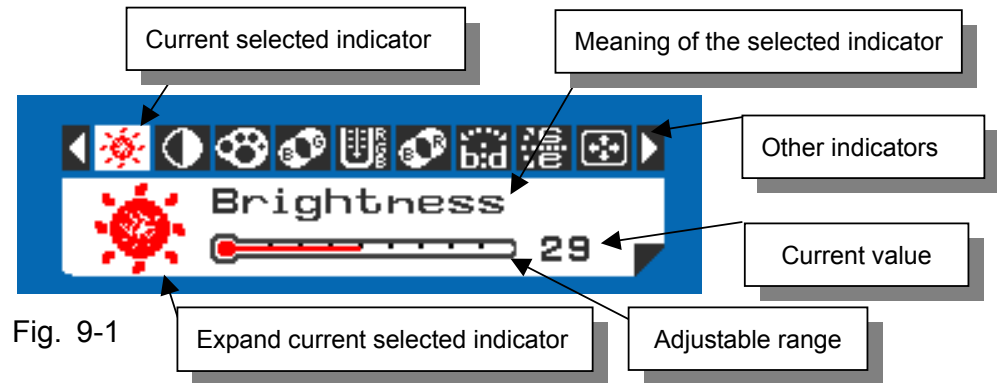

Operations of key board

1. To navigate the menu, press [MENU]. (Fig. 9-1)
2. The indicator lighting up in white color is the selected adjustment item.
3. To Next Item of the menu, press [MENU] again.
4. The operations below are only available when • MenuŽ is started.
5. Press [UP] / [DOWN] to adjust the value of the selected item.

Overview of the menu















Indicator	Meaning	Adjustable range	For	Remark
	Brightness	0 64	AV / S-Video / VGA	Adjust-Bar
	Contrast	0 64	AV / S-Video / VGA	Adjust-Bar
	Color	0 64	AV / S-Video	Adjust-Bar
	Tint	0 32	AV / S-Video	
	Sharpness	0 16	AV / S-Video	Adjust-Bar
	Color Tone	Normal / Warm / Cool	AV / S-Video / VGA	
	H-Position	-25 +25	AV / S-Video / VGA	Balance-Bar
	V-Position	-10 +10	AV / S-Video / VGA	Balance-Bar
	Auto		VGA	
	Scan	Over Scan / Under Scan	AV / S-Video	
	Information		AV / S-Video / VGA	Fig. 9-2
	Setup		AV / S-V	Fig. 9-3
	Factory Set		AV / S-Video / VGA	
	Exit		AV / S-Video / VGA	

Fig. 9-2







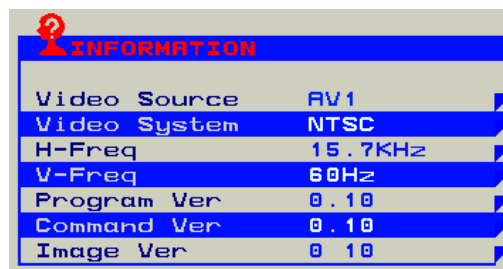

Setup Menu

Firmware VER 0.25 above



Fig. 9-3

Indicator	Meaning	Adjustable range	Function	Remark
	Show Status	ON / OFF	Show screen status.	ON: Show OFF: Hidden
	Blue Screen	ON / OFF	If loss signal will put on the blue or black screen.	ON: Blue OFF: Black
	Auto Power On	ON / OFF	Power input module will be auto turn on.	ON: Auto OFF: Manual
	Auto Sleep	OFF / 3s / 5s / 15s / 30s	If signal loss over setting times will be power off.	ON: Auto OFF: Normal
	Detect Source	ON / OFF	Auto detection which source in exist.	ON: Auto OFF: Normal
	Return			

Note : Priority : Auto Sleep > Auto Power On

Note : VGA Only don't have Detect Source function.

10.2 Operation

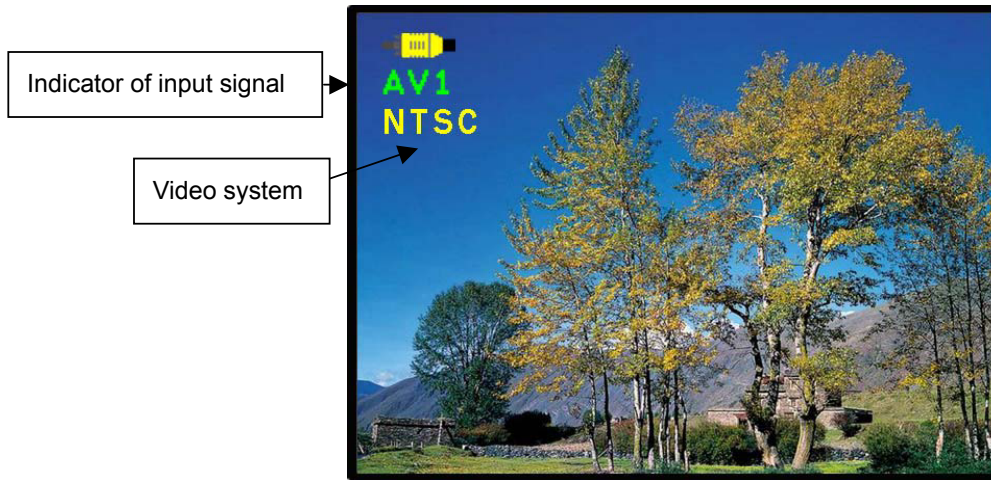

Fig. 9-4

[Power] Monitor power on / off

[Source] Input signal switch

Overview of input signals

Indicator	Input signal	Interface	Video system
	VGA	Analog RGB	640x480_60 / 800x600_60

11. Application Schematic Diagram

11.1 Application Circuit

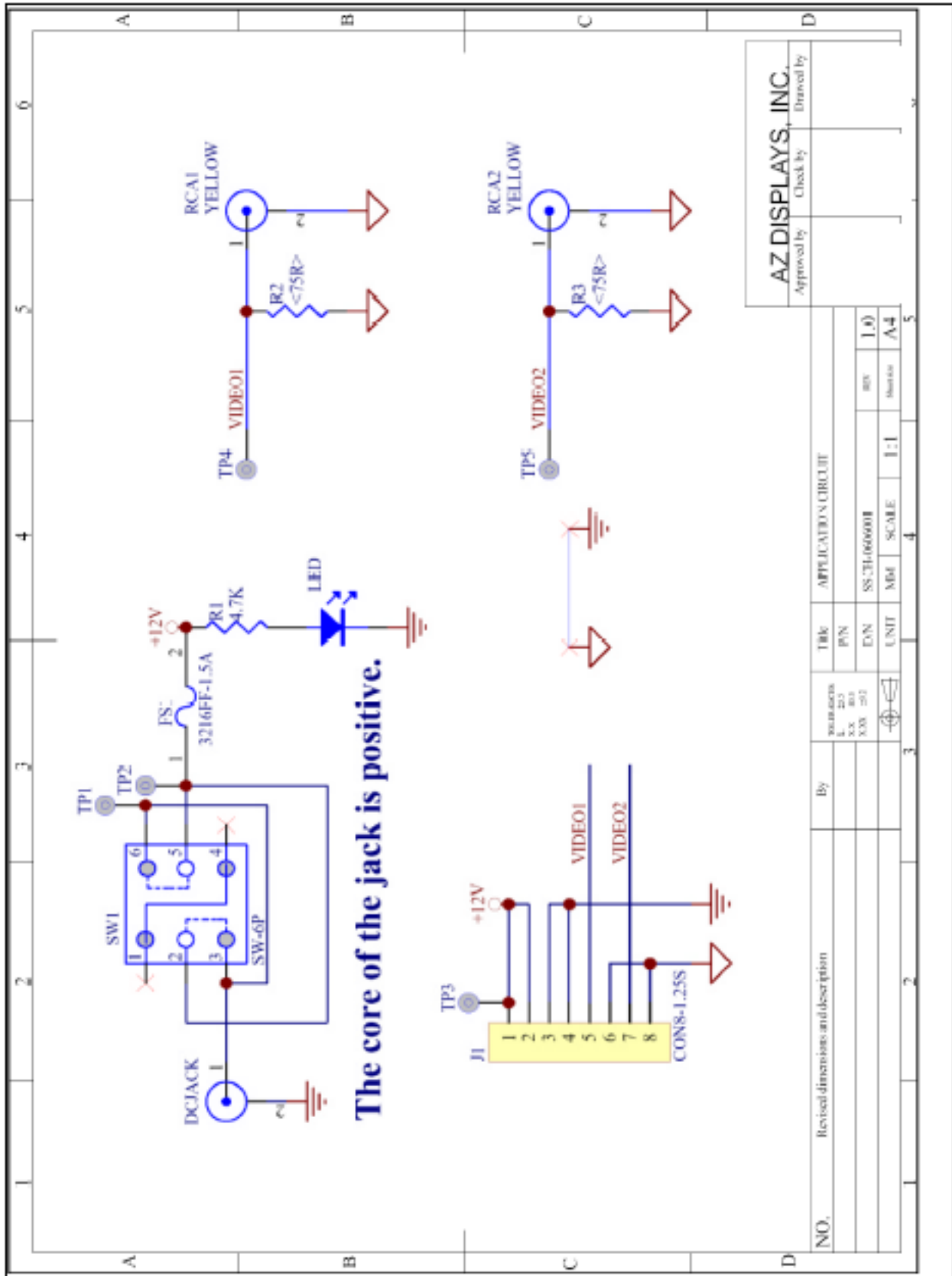

11.2 Key and IR Circuit

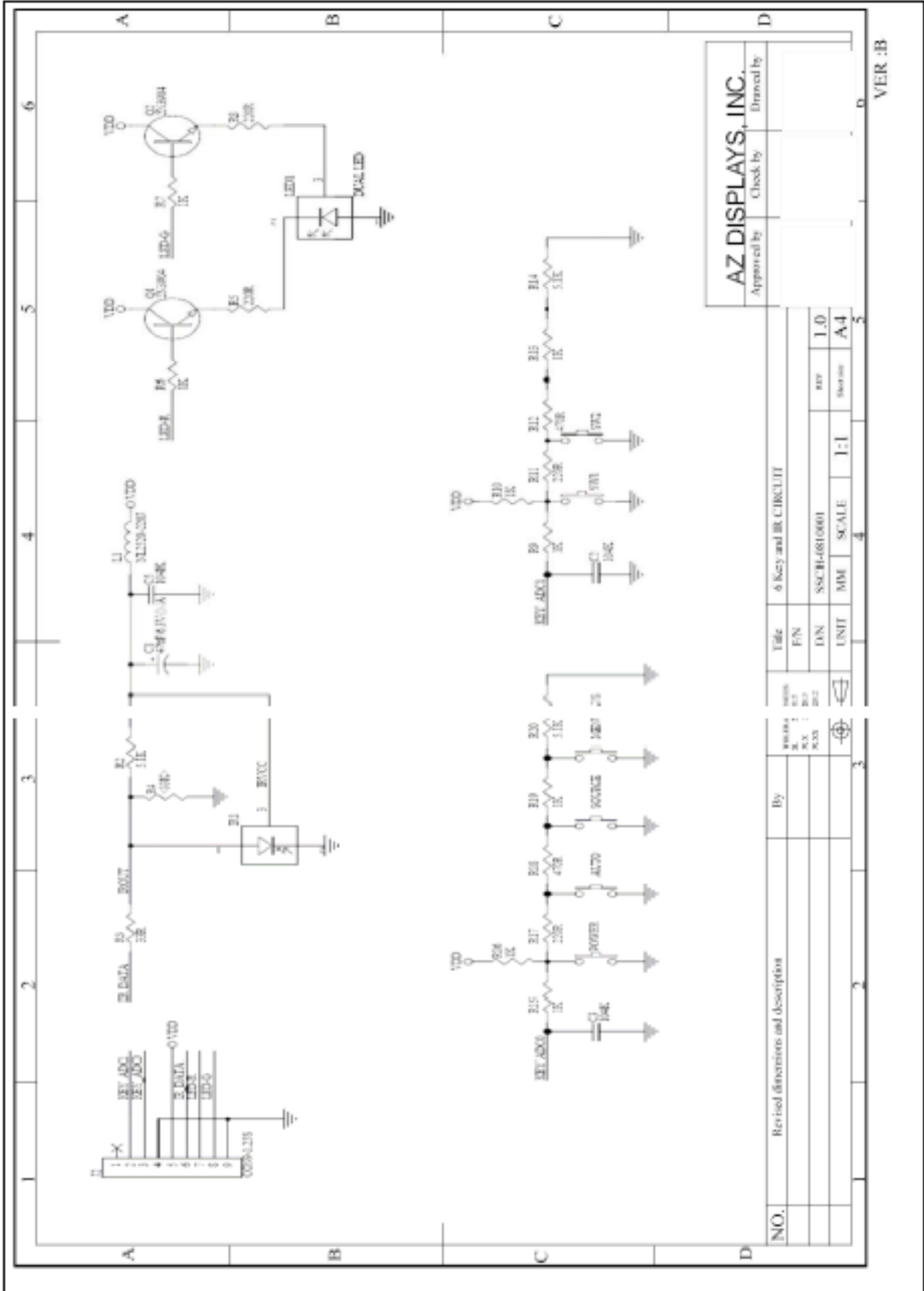

11.3 Keyboard

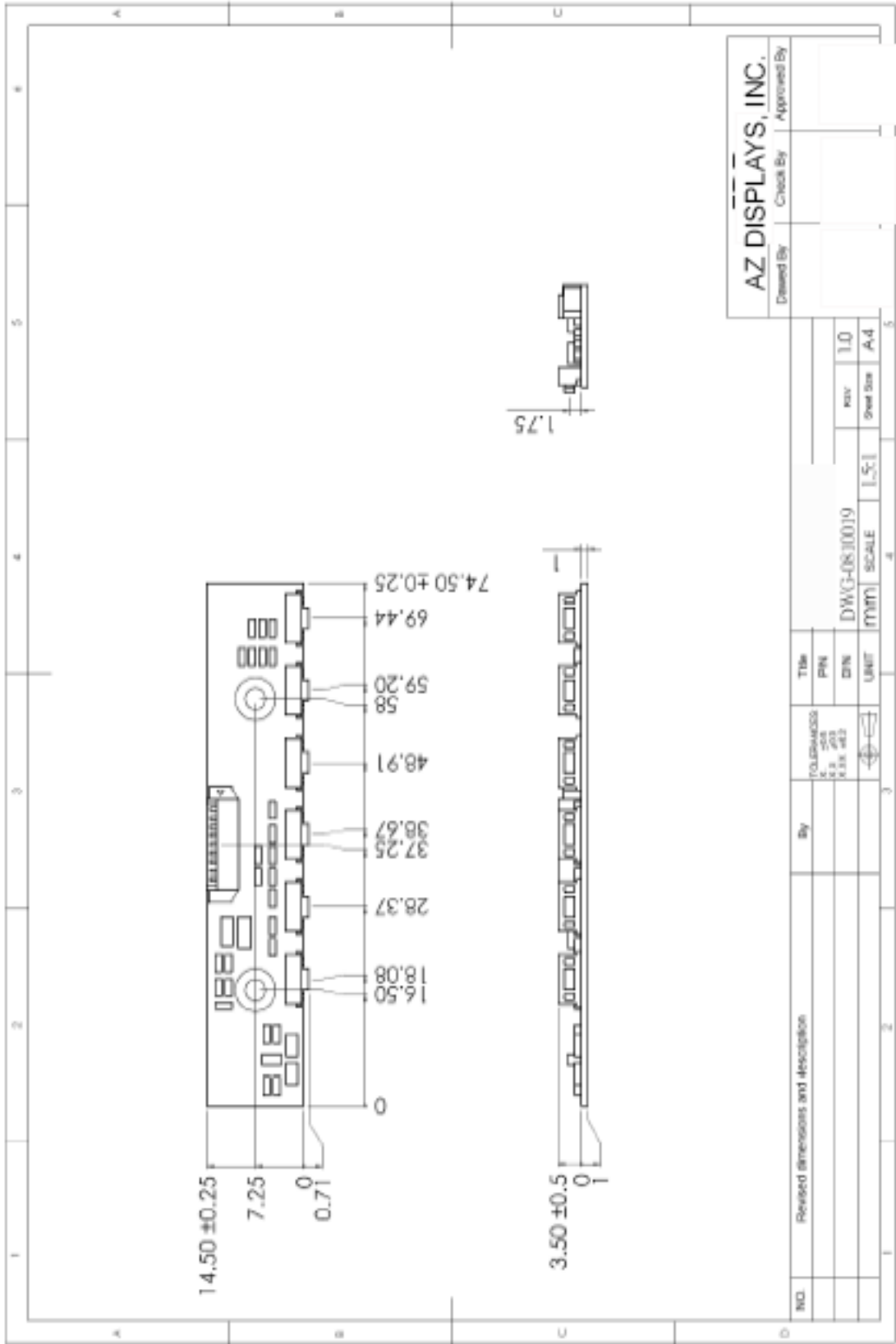

11.4 S-Video and RCA Input Board

