



# PRODUCT SPECIFICATION

**Model No:CST-S56320B7/S56321B7**

## Descriptions:

- 0.56 Inch Triad Digit SMD Display
- Emitting Color : Super Bright Blue



CUSTOMER APPROVED SIGNATURES	APPROVED BY	CHECKED BY	PREPARED BY

**CHINA SEMICONDUCTOR CORPORATION**  
Address:2FL. NO.909,Chung-Cheng Road,  
Chung-Ho City Taipei Hsien,Taiwan.

Tel:886-2-2223-9696  
Fax:886-2-2223-9377

**OPTO PLUS TECHNOLOGIES CO.,LTD**  
Address:696 Shun jiang Rd.,Ji Shan St.Shaoxing,  
ZheJiang,China

Tel:86-0575-88623888  
Fax:86-0575-88623112



**Model No : CST-S56320/S56321B7**

**Features -**

1. 0.56 inch (14.20mm) digit height.
2. Qualified according to JEDEC moisture sensitivity Level 2a.
3. RoHS compliant.
4. Low power consumption.
5. ESD>1KV(HBM).
6. Easy mounting on P.C. board.

**Device Selection Guide -**

Model No.	Chip		Description
	Material	Emitting Color	
<b>CST-S56320B7</b>	<b>InGaN</b>	<b>Super Bright Blue</b>	<b>Common Anode</b>
<b>CST-S56321B7</b>	<b>InGaN</b>	<b>Super Bright Blue</b>	<b>Common Cathode</b>

**Mechanical Dimensions -**

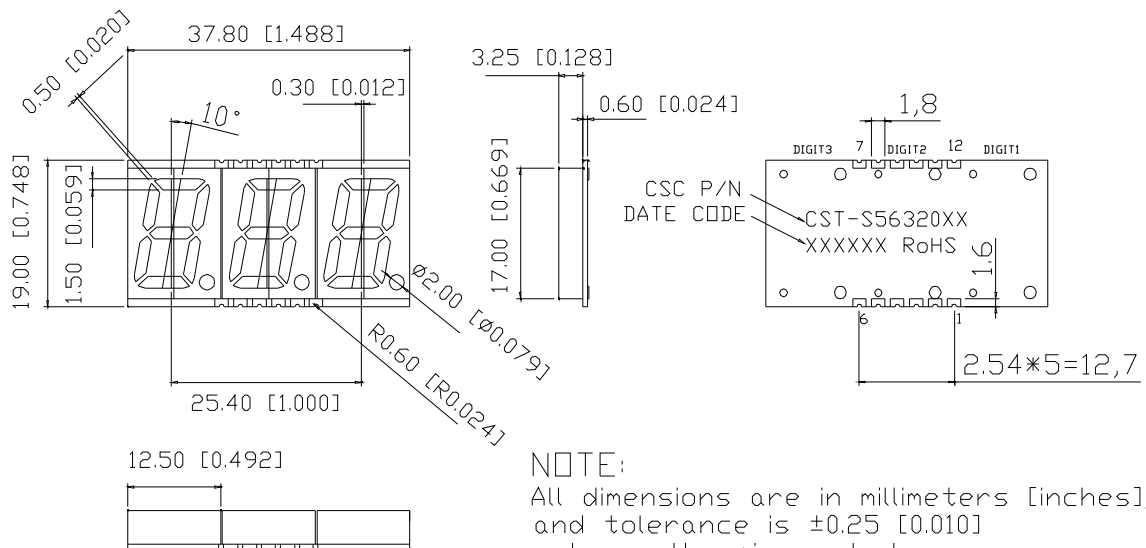



Model No : CST-S56320/S56321B7

Internal Circuit Diagrams -

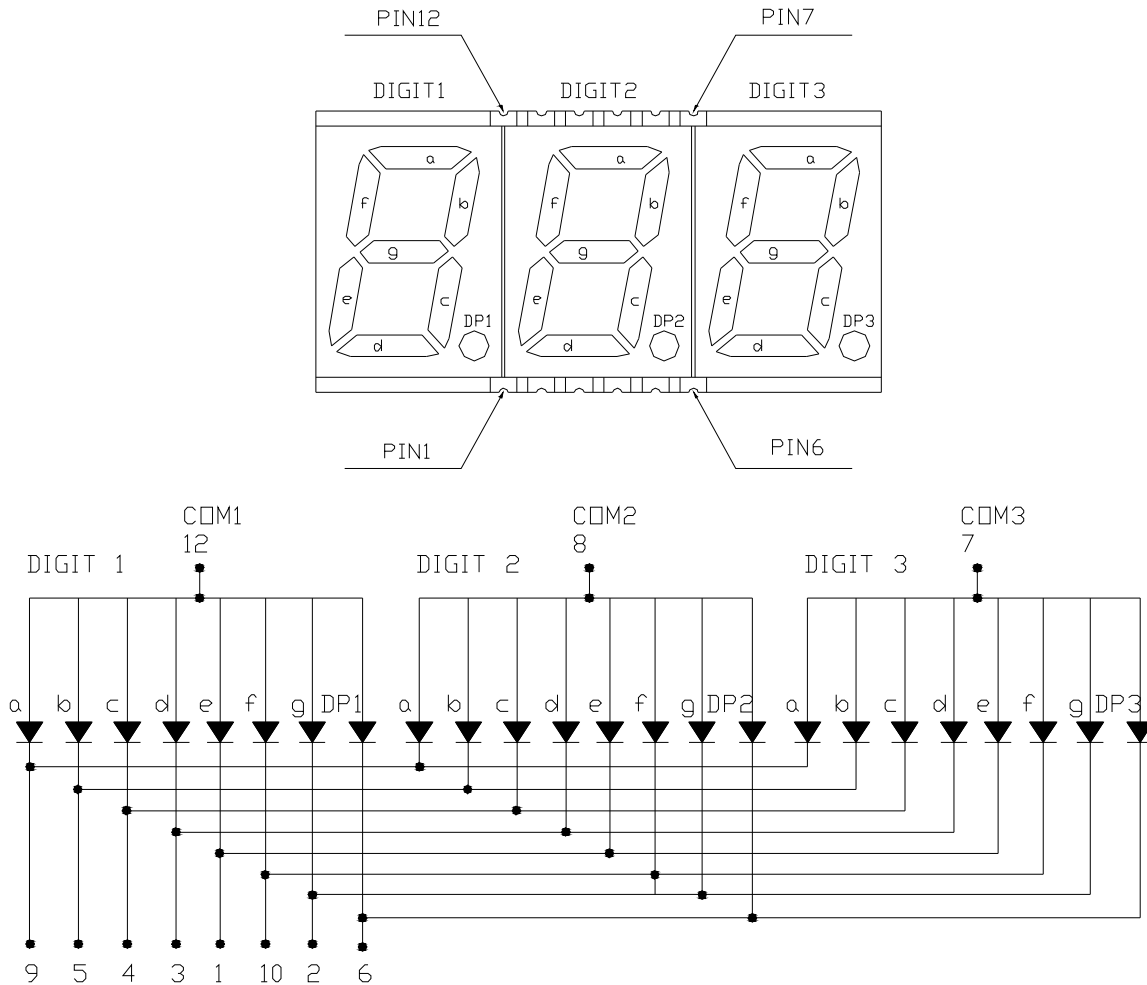

PIN 11 NC.

CST-S56320 Common Anode.  
( CST-S56321 Common Cathode. )



**Model No : CST-S56320/S56321B7**

■ **Absolute Maximum Rating -**

(Ta=25°C)

Parameter	Symbol	Rating	Unit
Power Dissipation Per Dice	P <sub>AD</sub>	120	mW
Continuous Forward Current Per Dice	I <sub>AF</sub>	30	mA
Peak Current Per Dice(duty cycle 1/10,1KHz)	I <sub>PF</sub>	100	mA
Derating Linear From 25°C Per Dice	-	0.4	mA/°C
Reverse Voltage Per Dice	V <sub>R</sub>	5	V
Operating Temp.	T <sub>opr</sub>	-40 ~ +105	°C
Storage Temp.	T <sub>stg</sub>	-40 ~ +105	°C

Note:Solder temperature 1/16 inch below seating plane for 3 seconds at 260°C

■ **Electro-optical Characteristics -**

(Ta=25°C)

Parameter	Symbol	Min.	Typ.	Max.	Unit	Condition
Forward Voltage Per Segment	V <sub>F</sub>	-	3.5	4	V	I <sub>F</sub> =20mA
Luminous Intensity Per Segment	I <sub>v</sub>	5	12	-	mcd	I <sub>F</sub> =10mA
Dominant Wavelength	λ <sub>d</sub>	-	470	-	nm	I <sub>F</sub> =20mA
Spectrum Radiation Bandwidth	Δλ	-	30	-	nm	I <sub>F</sub> =20mA
Reverse Current	I <sub>R</sub>	-	-	50	μA	V <sub>R</sub> =5V
Luminous Intensity Matching Ratio	I <sub>V-m</sub>	-	-	2:1	-	I <sub>F</sub> =10mA



Model No : CST-S56320/S56321B7

■ Typical Electrical / Optical Characteristics Curves -

(Ta = 25°C Unless Otherwise Noted)

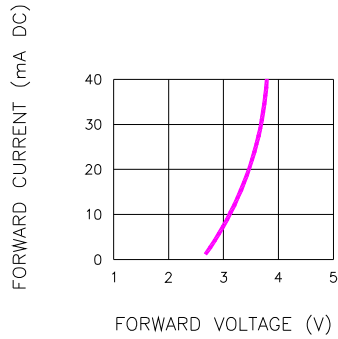

Fig.1 FORWARD CURRENT VS. FORWARD VOLTAGE

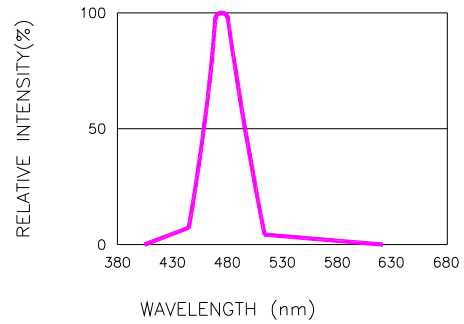

Fig.2 RELATIVE INTENSITY VS. WAVELENGTH

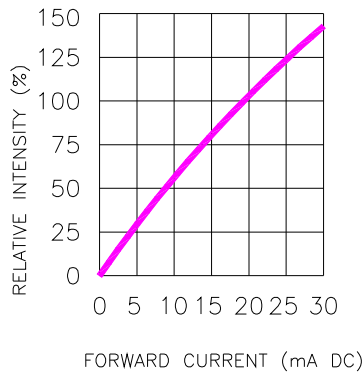

Fig.3 RELATIVE INTENSITY VS. FORWARD CURRENT

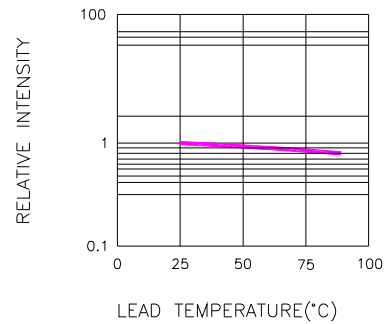

Fig.4 RELATIVE INTENSITY VS. LEAD TEMPERATURE  
(PULSED 20 mA; 300us  
PULSE, 10ms PERIOD)

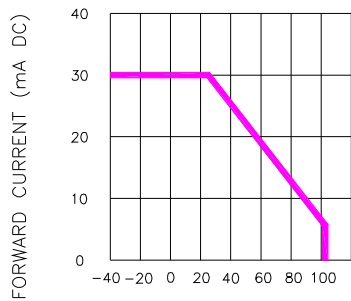

Fig.5 FORWARD CURRENT VS. AMBIENT TEMPERATURE

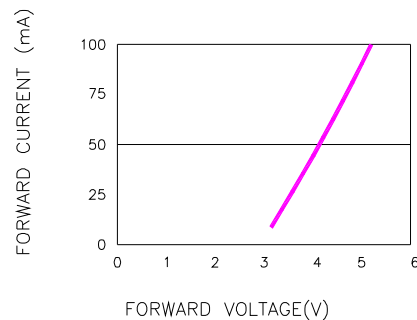

Fig.6 PEAK FORWARD VOLTAGE VS. FORWARD (100us TEST PULSE, 1% DUTY CYCLE)



Model No : CST-S56320/S56321B7

## SMT REFLOW SOLDERING INSTRUCTIONS

### ■ IR Reflow Temperature / Time :

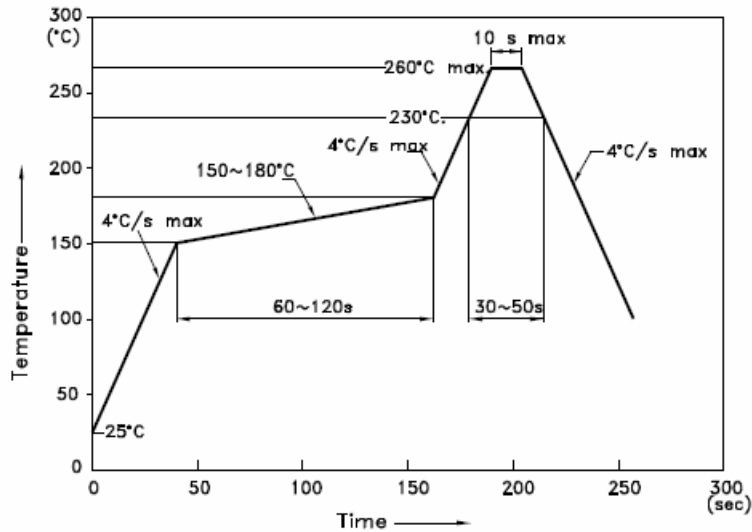

#### NOTES:

1. We recommend the reflow temperature 245°C(+/-5°C). The maximum soldering temperature should be limited to 260°C.
2. Don't cause stress to the epoxy resin while it is exposed to high temperature.
3. Number of reflow process shall be 2 times or less.

### ■ Soldering Pad Size

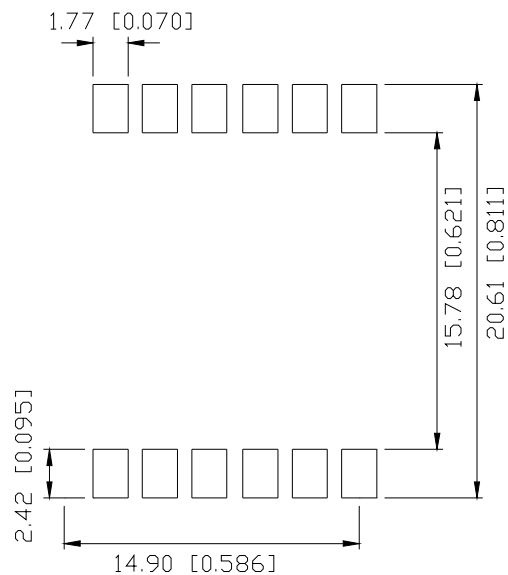



Model No : CST-S56320/S56321B7

### REEL DIMENSIONS

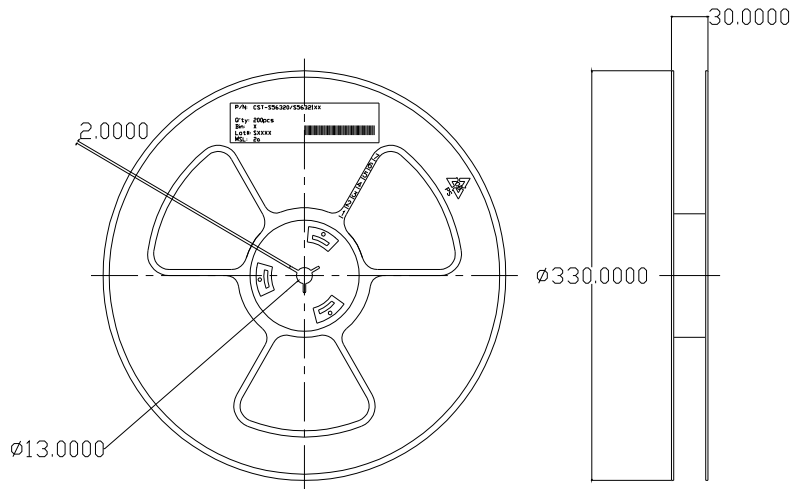

### PACKING & LABEL SPECIFICATIONS

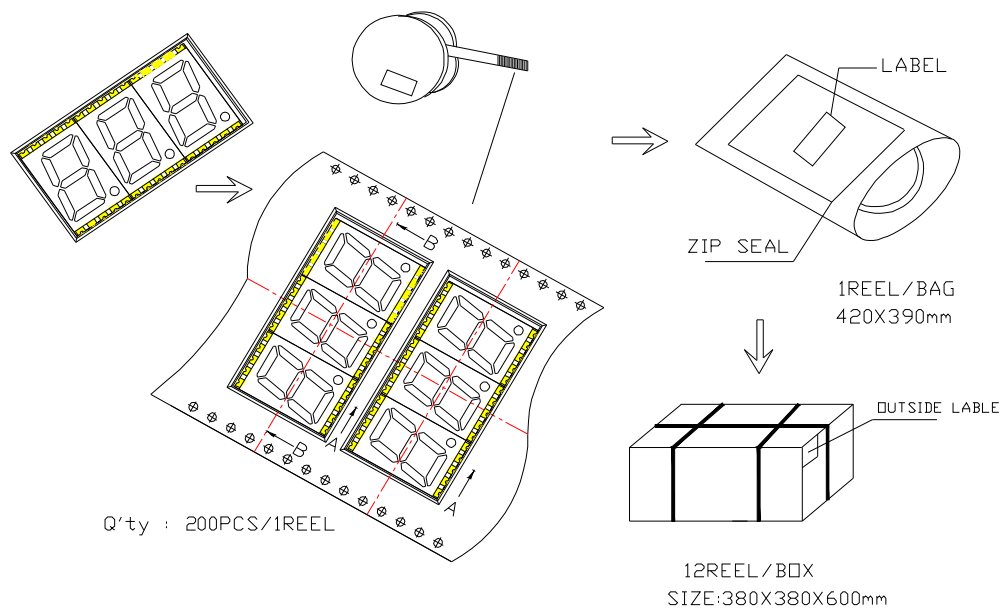

Note: The specifications are subject to change without notice. Please contact us for updated information.